

## **Geethanjali College of Engineering and Technology**

Accredited by NAAC with 'A' Grade & NBA, Approved by AICTE and Affiliated to JNTUH  
Cheeryal(V), Keesara(M), Medchal Dist., Telangana – 501 301.

# **Hackathons for the Academic Year: 2020-21**



# Geethanjali College of Engineering and Technology

(UGC Autonomous Institution Accredited by NBA & NAAC,  
Permanently Affiliated to JNTUH, ISO 9001:2015 certified)  
Cheeryal (V), Keesara (M), Medchal. Dist. 501301

## Geenovate Foundation – a Section '8' company

### Incubation Center at GCET

#### Executive Summary as on 23<sup>th</sup> May 2022

Geenovate Foundation, the incubation center at Geethanjali College of Engineering and Technology (GCET) – is a non profit 'section 8 company'. The incubation center was established in the year 2014, but was incorporated on 23<sup>rd</sup> March 2022. It has been working under the guidelines of its parent organization GCET, Institution Innovation Council (IIC), Ministry of Education, New Delhi and JHuB of Jawaharlal Nehru Technological University Hyderabad (JNTUH). It has implemented a strategic plan as early as Dec 2017 to support innovation and entrepreneurship ecosystem in the college and has implemented its innovation and startup policy on 25<sup>th</sup> March 2022, in line with the National innovation and Start up policy (NISP) 2019.

#### **Vision and Mission:**

The goal of establishing an Incubation Center at the college is to create an atmosphere for students and faculty to produce, grow and commercialize the ideas of creative students through appropriate training and mentoring. Forming a multi-sector, diverse team that can use a wide variety of instruments and methodologies such as design thinking, solution for concept management, open innovation, crowd sourcing and human centric design to help the community ideate, guide discussions, prototypes and solutions and create employment creators

#### **Activities:**

It has adopted an innovation and startup policy for encouraging and nourishing the innovation quotient and entrepreneurial abilities of the students coming with innovative ideas and also to improve the employability

  
**PRINCIPAL**  
Geethanjali College of Engg. Tech.  
Cheeryal (V), Keesara (M), R.R. Dist. (A.P.) - 501 301



levels of the other interested students. The incubation center invites ideas not only from students, faculty but also from any individuals of any nationality! Appropriate ideas, after short listing, will be seed funded by GCET and hand-held for securing funding opportunities and progress to the next level.

An expert committee to guide the incubatees is constituted with a mix of eminent personalities coming from different backgrounds viz., serial entrepreneurs, venture capitalists, industrialists, alumni at important positions and enthusiastic faculty.

**Mentors empanelled by the incubation center to help student innovators/entrepreneurs.**

Name	Designation	Positions Held
Dr. S. Udaya Kumar	Principal	Professional teaching experience in New Zealand, Ethiopia, Morocco and India for more than 36 years. Had his Bachelors, two M.Tech degrees and Ph.D degree from universities from India and New Zealand. Held several positions as Principal, Deputy director. He is also a reviewer of Scopus and Web of Science Indexed journals published from USA, Honk Kong, Taiwan.
Dr. Anil Kumar Puppala	Professor – EEE Dept, Convener and I/C Incubation center GCET	M.S., Ph.D from State University of New York at Buffalo. Held positions as R&D Design Engineer at K&H Industries New York, Design Manager at Hical Technologies Bengaluru India, Managing Director at Vijetha Engineering Industries and Vijetha Integrated Systems (family owned and managed companies)
Mr. Srinivas Pothapragada	Entrepreneur	Serial Entrepreneur and Angel Investor. Founder of ‘Sanovi’ (based out of Boston USA) which was bought by IBM. Sanrise® Group Inc., the world’s leading storage service provider with presence in over 18 countries, based out of Dublin, California. Srinivas helped Sanrise secure over \$215 Million in equity participation. Sanrise delivered the world’s first Virtual Storage Appliance platform and a leading storage management software suite (now part of DELL/EMC).
Mr. Lolla Srinivas	Entrepreneur	M.S from Harvard University, Currently with Bees Consultancy
Mr. Sri Charan Lakkaraju	Entrepreneur	Founder StuMagz.com student motivator, Forbes 30 under 30 listed in 2018
Mr. SPV Reddy	Alumni/Entrepreneur	Presently with National Cyber Defence Research Center (NCDRC)
Mr. Ramesh RamGopal	Alumni/Entrepreneur	CEO <a href="http://www.techfeo.com">www.techfeo.com</a> IT services provider.
Mr. Bharath	Entrepreneur/Investor	Retired from Indian Air-force. Entrepreneur and Investor
Dr. Nagamani	Faculty, English Dept, GCET	Coordinator of Centre for Soft Skills Development at GCET. Instrumental in helping students imbibe Creative and Critical Thinking by applying ‘Design Thinking’ methodologies.
Dr S Shyam Kumar	Faculty, HoD, Dept of ME	Formerly headed the ‘Applied Research Centre’ at Ambala college of engineering and applied research, Ambala cantonment (State of Haryana) and consultant to 17 small scale industries nearby for product development during 2007 - 11. Also worked as consulting head- R&D in AI/ML at Fusion Technologies, Hyderabad 2020-21.
Mr. Ravi Kanth	Faculty, MBA	An Engineering graduate from REC Warangal (Presently NIT



	Dept	Warangal) with Masters in Business Administration having 25 years of IT Industry experience managing large complex projects on multiple technologies working in India, USA and UK. Certified PMP.
Dr. Sita Madhavi	Faculty, MBA Dept	Co-coordinator for Entrepreneurship Development Cell along R&D-MBA Dept. Supports students in designing Business Models.
Mr. Ogirala Siva Kumar – Faculty	Faculty, CSE Dept	Formerly with AMD R&D Centre (I) Pvt. Ltd as Project Manager, Infineon Tech. India Pvt. Ltd as ASIC Design Manager, Intel India Design Centre 2001-03 as Lead Design Engineer, Motorola India Design Centre 1998-11, Technical staff Cadence Design Systems 1996-98, and as Scientist “C” Research Centre Imarat (RCI), DRDO 1992-96
Dr. Harsha Praneeth	Faculty, CE Dept	Associate Professor, Department of Civil Engineering, also a Co-founder for a social startup – Allika Pvt. Ltd.
Dr. GaganDeep Arora	Faculty, CSE Dept	Formerly with Institute of Technology and Science (ITS), Noida, UP. He was instrumental in establishing Incubation center with an INR 2.5 Cr grant and helped about 11 startup incubatees at ITS.
Dr. ValliSree	Faculty, ECE Dept	Department of Electronics and Communication Engineering Formerly as Technical Test Lead Independent Validation Solutions & Infosys Ltd. 12-07-2004 to 21-08-2012
Dr. Madhuri Bayya	Faculty, EEE Dept	Formerly worked at BITS-Pilani Hyderabad campus. Establishing labs in electrical domain is the specialty. Domain expertise in Electric Vehicles. Associated with startup Automotive wheels Pvt. Ltd. Executive member of IEEE PES Hyd. Section.
Mr. Subrhamanium	Faculty, ECE Dept	Department of Electronics and Communication Engineering, Formerly with Sree ‘V’ Link Teleservices 2001-02 as Technician and as Technician & Supervisor IRSO,SDSC-SHAR, Sriharikota 2003-05.

  
**PRINCIPAL**  
 Geethanjali College of Engg. Tech.  
 Cheeryal (V), Keesara (M), R.R. Dist. (A.P.) 501301



**Startups as on 23<sup>rd</sup> May 2022**

Event	Founder	Co-Founder	Co-Founder	CIN Number	Website Address
Samyag drushti Surveillance Private limited	Juluri Manish (20R11A0482-ECE Dept)	Mr. Sujit Rayaprolu (19R11a0438-ECE Dept)		U31900TG2022P TC161236	
Zweirad Electric Private Limited	Mr. Rahul Reddy (17R11A0339 ME Dept)	Mr. Manish (17R11A0316 ME-Dept)	Mr. Aadhari Santosh (Faculty ME Dept)	U34300TG2021P TC150123	<a href="http://www.Zweiradelectric.com">www.Zweiradelectric.com</a>
Retro-E Vehicles Private Limited	Mr. Kotte Yashwanth Reddy (Alumni EEE Dept)	Dr.Radhika Dora (Faculty EE Dept)		U29190TG2021P TC149993	<a href="http://www.retroe-vehicles.com">www.retroe-vehicles.com</a>
Automotive Wheels Private Limited	Dr. Madhuri Bayya (Faculty EE Dept)	Mr. Gouse Basha Mulla (Faculty EE Dept)	Mr. Prashanth Masadi (Faculty EE Dept)	U31904TG2021P TC150207	

**Equipment:**

Description	Make/Model and Remarks
Desktop computers	5
USB Oscilloscope	Picoscope 2206B
50 MHz Four Channel Oscilloscope	Scientech
Soldering and DeSoldering Station	1 No.
Raspberry PI 8GB RAM Microcontrollers	8 Nos.
3D Printers	RXP2200I Adroitec Engg. solution Pvt. Ltd 2 Nos.
Glass cutter	1 No.
Laser cutter	1 No.
Mini Desktop Lathe cum Milling Machine	1 No.
Assorted Power Tools	-
PCB Milling and Prototyping machine	One set
Digital Oscilloscopes, Function Generators and Multimeters	2 sets each
DC Regulated Power Supplies	2 Nos.
Micrometers and Vernier Calipers	2 sets each

**PRINCIPAL**  
 Geethanjali College of Engg. Techn.  
 Cheeryal (V), Keesara (M), R.R. Dist. (A.P.) - 501 301

## Infrastructure Facilities for promotion of innovation and entrepreneurship activities

S. No.	Name of the Facility	Room No. & Location	Room	Area
1	Innovation and Entrepreneurship Development Centre (IEDC)	N104	Block 3	69 m <sup>2</sup>
2	Makerspace	103, 104	Block 1	120 m <sup>2</sup>
3	Centre for Excellence (Innovation and Entrepreneurship)	R306	Block 2	38 m <sup>2</sup>
4	Incubation Centre	N321	Block 3	34 m <sup>2</sup>

### Collaborations/Associations:

- Member - Ministry of Education's (MoE) Institution's Innovation Council (IIC) since 2018-19  
Has been conducting IIC's calendar of activities. Highest ranking 3 out of 5 stars
- JHuB – JNTUH's Incubation Center since 2018
  - JHuB Accelerator program
  - JHuB Ignite Program
  - JHuB's Enlite Program
  - JHuB's Excite Program
- T-HuB – Community Membership since Jun 2021.  
First batch of 50 students undergoing training on concepts of Entrepreneurship and startups

PRINCIPAL  
Geethanjali College of Engg. Tech.  
Cheeryal (V), Keerasa (M), K.R. Dist. (A.P.) - 501 301



## Overall Activities of Incubation Center at GCET

### Schedule of activities of Innovation and Incubation Center at GCET

S. No.	Activities	Aug	Sept	Oct	Nov	Dec	Jan	Feb	Mar	Apr	May	Jun	July
1	IIC - AICTE	<p>Webinars/Competitions/workshops throughout year as per "calendar of Activities" suggested by IIC-AICTE. Quarterly reports</p>											
2	JHuB	<p>36 Hr Hackathon, Internal competitions - Shortlist &amp; nominate teams to Ignite (First Year), Enlite (II Year), Excite (Third Year)</p>											
3	ARIIA	<p>Prelim Information Complete information uploading in portal</p>											
4	CVA	<p>Ideathon Train Teams Team Nomination &amp; Training for prototype Building Project Execution</p>											
5	Incubation Activities	<ol style="list-style-type: none"> <li>1. Ideathon/Hackathons and selection of interdisciplinary teams</li> <li>2. T-HuB (T-Tribe) - Monitoring of selected students attending T-Tribe's launch Pad programme</li> <li>3. Handholding of teams with potential ideas all the way to startups - by organizing investor pitching sessions with support from - Patent Attorneys and Company secretary /Chartered Accountant</li> <li>4. Mentoring Sessions for Startups/teams selected for CVA</li> <li>5. Incubation Center's Webpage maintenance <a href="http://incubation.geethanjaliapp.com/">http://incubation.geethanjaliapp.com/</a></li> </ol>											

#### Glossary of terms

**ARIIA** Atal Ranking of Institutions on Innovation Achievements

**CVA** Chhatra Vishwakarma Awards - Annual National level Competition

**IIC** Institution's Innovation Council promoted and guided by AICTE - Ministry of Education (MoE)

**JHuB** Innovation HuB for supporting Technology based startups/entrepreneurship - Supported by JNTUH

**T-HuB** A Section 'B' Company sponsored by Govt of Telangana, Indian School of Business, Nalsar Univ, IIT Hyderabad - to improve Startup ecosystem

**PRINCIPAL**  
 Geethanjali College of Engg. Tech.  
 Cheryal (V), Keesara (M), R.R. Dist. (A.P.) - 501 302

## Number of Projects and students

Acad. Year	No. of Projects	Final Regd. students	JHub / EXCITE Enrolled Students
2021-22*	189	575*	
2020-21	115	555	9
2019-20	64	290	9
2018-19	80	95	2
2017-18	7	100	21
2016-17	8	50	6
2015-16	3	25	6
2014-15	3	25	--

- Includes students registered for the Launchpad program on entrepreneurship in collaboration with THuB.

PRINCIPAL  
Geethanjali College of Engg. Tech  
Cherryal (V), Keeruru (M), K.R. Dist. (A.P.) - 501 307

PRINCIPAL  
Geethanjali College of Engg. Tech  
Cherryal (V), Keeruru (M), K.R. Dist. (A.P.) - 501 307



## Some of the accomplishments of the incubation center at GCET

- Incubation Center of GCET was chosen to conduct Toycathon – Digital Version as a Nodal Center

**GEETHANJALI**  
COLLEGE OF  
ENGINEERING & TECHNOLOGY

**भारत**  
संघ

A Proud Moment for Everyone Associated  
**GEETHANJALI COLLEGE OF ENGINEERING AND TECHNOLOGY, HYDERABAD**  
will serve as Nodal Centre for

**Toycathon 2021**  
by Govt. of India

Let's Get Our Acts Together to  
**Make it a Grand Success**

<https://tinyurl.com/gcet-toycathon2021>

Mr. G. R. Ravinder Reddy  
Chairman

Guest of Honor: Mr. Shivarathri Chandra K.  
Co-Founder Butterfly Fields Pvt. Ltd.

Chief Guest: Mr. Sudheer Reddy K.  
President Tulsyantha Industrialists Federation.

**Participating Ministries**

Ministry of Education  
Ministry of Information and Public Relations  
Ministry of Skill Development and Entrepreneurship  
Ministry of Health and Family Welfare  
Ministry of Commerce & Industry  
Ministry of Statistics  
IISHE  
ANTE

✓

**PRINCIPAL**  
Geethanjali College of Engg. Tech.  
Cheerlyal (V), Keesara (M), R.R. Dist. (A.P.) - 501 30.

- Conducted Chhatra Vishwakarma Awards (South Central Regional Competition) in association with AICTE and received an appreciation in this regard.



Phone : 040-23340113, 040-23345071  
Email : scro@aicte-india.org  
Website : www.aicte-india.org



सत्यमेव जयते

GLET/73/2019-20, Dt. 27/12/19

अखिल भारतीय तकनीकी शिक्षा परिषद

(भारत सरकार का एक स्वीकृतिक शिक्षण)

(मानव संसाधन विकास मंत्रालय, भारत सरकार)

ALL INDIA COUNCIL FOR TECHNICAL EDUCATION

(A Statutory Body of the Govt. of India)

(Ministry of Human Resource Development, Govt. of India)

South Central Regional Office

Block No. : 201 to 204 & 221 to 224, 2nd Floor,

Swarna Jayanthi Commercial Complex,

Armeerpet, Hyderabad - 500 038

SCRO-AICTE/CVA-2019/ 504

Date: 18.12.2019

To

The Principal/MD,  
Geethanjali College of Engineering and Technology,  
Cheeryal Village,  
Keesara Mandal,  
Hyderabad,  
Telangana 501301.

Respected Sir,

I wish to thank you wholeheartedly and express my sincere gratitude for hosting the Regional Convention of Chhatra Vishwakarma Awards - 2019 on 13.12.2019 at your Institute.

It would be than appropriate to mention that the warmth of AICTE, SCRO, Hyderabad has received from your end was overwhelming.

I also convey my sincere thanks to the Principal, Dr. Anil Puppala and other members of your team for their help.

I once again thank you for extending all your help for the above event and look forward to have such cooperation in future.

Thanking you,

Regards,

(DR. AMIT VISHWASRAO SALUNKHE)  
ASST. DIRECTOR & REGIONAL OFFICER

To  
Dr Anil  
27/12

PRINCIPAL  
Geethanjali College of Engg. Tech.  
Cheeryal (V), Keesara (M), R.R. Dist. (A.P.) - 501 301.



**Summary of Hackathons conducted in collaboration with AICTE/JHuB as on  
5<sup>th</sup> May 2022**

Academic Year	Title of Hackathon	Date	No. of students participated
2021-22	Smart India Hackathon (SIH) - Internal Hackathon conducted in GCET to shortlist top 15 teams to be nominated to SIH-2022	12-Mar-22	132
2020-21	Toy-Hackathon - National level hosted by GCET in association with AICTE (19 students of GCET submitted ideas and 60 external students participated at regional level)	22-23 Jun 2021	79
	Ideathon to promote innovation (GCET)	12-Dec-20	68
2019-20	Smart India Hackathon (SIH) - Internal Hackathon to shortlist top 15 teams to SIH	23-24 Dec 2019	96
	36-Hr Hackathon on the theme 'Robotic Process Automation' in association with JHuB.	23-24 Dec 2019	109
2019-20	Chhatra Vishwakarma Awards - National level event conducted by GCET in association with South Central regional committee of AICTE (5 students of GCET and 123 external participants)	13-Dec-19	128
2018-19	36-Hr Hackathon on the theme 'AgriTech' in association with JHuB.	5-6 Jan 2019	86
2017-18	Hackathon 2018 to promote innovation in association with JHuB	20-Jan-18	72
	Idea Presentation to promote innovation	20-Jan-18	

**No. of students participated in the innovation and entrepreneurship activities (branch wise & Year wise) during the AY 20-21**

	Ist Year	2nd Year	3rd Year	4th Year	Total
CSE	20	7	4	5	36
CSE DS	7	0	NA	NA	7
CSE AIML	6	0	NA	NA	6
CSE IOT	7	0	NA	NA	7
Civil Engg	5	0	0	5	10
ECE	22	3	17	10	52
EEE	6	2	5	8	21
IT	5	2	0	0	7
ME	4	1	6	14	25
<b>Total</b>	<b>82</b>	<b>15</b>	<b>32</b>	<b>42</b>	<b>171</b>



## Calendar of Activities planned for the year 2021-22

IIC Calendar Activities for Academic Year 2021-22				
Semester I				
Quarter 1 Q1: -1st Sept to Nov 21				
Sl. No.	Activity	Thrust Area	IA Ambassador Coordinator at GCET	Tentative Date/Date Conducted
1	IIC Council formation or upgradation (of existing council) at Institute level. Conduct first council meeting.	Inspiration Motivation and Ideation	Dr. Anil Puppala	20-Oct-21
2	Workshop on "Entrepreneurship and Innovation as Career Opportunity"		Ms. Preethi Prasada	1st week of Nov
3	My Story - Motivational Session by Successful Innovators		Dr. Valli Sree	
4	My Story - Motivational Session by Successful Entrepreneur/Startup founder.		Dr. Spandana	2nd week of Nov
5	Session on Problem Solving and Ideation Workshop		Dr. Nagamani	
6	Exposure and field visit for problem identification		Dr. Harsha Praneeth	3rd week of Nov
7	Pitching Event for Ideas Scouted & linkage with Innovation Ambassadors for mentorship support.		Dr. Neeraja (All IAs to mentor)	
8	Developing Online Repository of Ideas Developed and Wayforward plan		Dr. Anil Puppala/OVPR	4th week of Nov
Quarter 2:- 1st Dec to Feb 22				
1	IIC Council Meeting- Review of Q1 progress and Planning for Q2.	Validation and Concept Development	Dr. Anil Puppala	4th Dec 2021
2	Workshop on Design Thinking, Critical thinking and Innovation Design		Dr. Madhuri Bayya	1st week of Dec
3	Expert talk on "Process of Innovation Development & Technology Readiness Level (TRL)" & "Commercilation of Lab Technologies & Tech-Transfer"		Dr. Neeraja	2ndweek of Dec
4	Workshop on Entrepreneurship Skill, Attitude and Behaviour Development		Dr. Sita Madhavi	3rd week of Dec
5	Session on Achieving Problem-Solution Fit & Product-Market Fit		Mr. Sudershan Riika	2nd week of Jan 2022
6	Field/Exposure Visit to Pre-incubation units such as Fab lab, Makers Space, Design Centres, City MSME clusters, workshops etc.		Dr. Anil Puppala/OVPR	3rd week of Jan
7	Pitching Event for PoCs developed & linkage with Innovation Ambassadors for mentorship support.		Dr. Harsha Praneeth, Mr. Sandeep (All IAs to mentor)	Jan - Feb 2022

  
**PRINCIPAL**  
 Geethanjali College of Engg. Tech.  
 Cheeryal (M), R.R. Dist. (A.P.) 501 201



8	Developing Online Repository of Proof of Concepts (PoCs) Developed and Wayforward plan		Dr. Anil Puppala/OVPR
---	--	--	-----------------------

**Semester II**

**Quarter 3:- 1st March to May 22**

1	<b>IIC Council Meeting- Review of Q2 progress and Planning of Q3.</b>	Validation and Innovation & Business Model Development	
2	Workshop on Prototype/Process Design and Development - Prototyping		
3	Session/ Workshop on Business Model Canvas (BMC)		
4	Field/Exposure Visit to Incubation Unit/Patent Facilitation Centre/Technology Transfer Centre		
5	Session on "How to plan for Start-up and legal & Ethical Steps"		
6	Workshop on Intellectual Property Rights (IPRs) and IP management for start up		
7	DemoDay/Exhibition/Poster Presentation of Business Plan/Prototype developed & linkage with Innovation Ambassadors for mentorship support.		
8	Developing Online Repository of Business Plan/Prototypes Developed and Wayforward plan		

**Quarter 4:- 1st June to Aug 22**

1	<b>IIC Council Meeting- Review of Q3 progress and Planning of Q4</b>	Validation and Start-up Development	
2	Session on Innovation/Prototype Validation - Converting Innovation into a Startup (or) Session on Achieving "Value Proposition Fit" & "Business Fit"		
3	Session on Accelerators/Incubation - Opportunities for Students & Faculties - Early Stage Entrepreneurs		
4	Organise Session on "Lean Start-up & Minimum Viable Product/Business"- Boot Camp (or) Mentoring Session		
5	Session on Angel Investment/VC Funding Opportunity for Early Stage Entrepreneurs		
6	Session/ Panel discussion with innovation and Startup Ecosystem Enablers from the region/state/national level		

**PRINCIPAL**  
 Geethanjali College of Engg. Tech.  
 Chervu (V), Keesara (M), R.R. Dist. (A.P.) - 501 104

7	DemoDay/Exhibition/Poster Presentation of Start-ups developed & linkage with Innovation Ambassadors for mentorship support.		
8	Developing Online Repository of Start-ups Developed/incubated and Wayforward plan		

M

CONFIDENTIAL  
College of Engg. Tech.  
Cheeryal (V), Keeravani (M), R.R. Dist. (A.P.) - 501 301

Handwritten notes at the bottom of the page, including the word "Project" and other illegible text.



## List of Activities for the AY (21-22)

### Workshops/ Awareness Programs/ Hackathons

S.No	Event	Date
1	Problem solving and Ideation workshop through design thinking	24-29 Jan 2022
2	Entrepreneurship and Innovation as Career Opportunity - Industry Conclave on Electric Vehicles	14-19 Feb 2022
3	National Science week	28 Feb – 05 mar 2022
4	Project Exhibition (for high school students)	30 March 22
5	Internal Hackathon - SIH 2022	12 March 2022
6	Project Expo at Annual Technical Festival to link them with Innovation Ambassadors	28 April – 29 April 2022
7	National Technology Day	12 May 2022
8	IIC Council meeting -Q3Review	5 June 2020-21
9	Webinar on Steps to Startup	06 June 21
10	IIC Council meeting -ReviewQ3	5 June 2021
11	<u>ProtoType to Startup</u>	21 July 22
12	Webinar on building product fit in market	20 July 2021
13	Workshop on "Business Model Canvas"	10 july2021
14	Virtual Tour to TBI	7 July 2021
15	Workshop Business Model	27 July 21
16	Attendance-project exhibition	24 July21

PRINCIPAL  
 Seethanjali College of Engg. Tech.  
 Cheeryal (V), Keesara (M), R.R. Dist. (A.P.) - 501 301

17	IAs As Mentor	01July21
18	Project Exhibition	01 July 21
19	DIPP Registration startups_	12 Aug 21
20	Shark Tank innovative business models	01 Aug 21
21	Orientation Session FinalQ	27 <sup>th</sup> Aug 2021
22	Panel Discussion Banner	22nd Aug 2021
23	Legal, Ethical Steps about startups webinar	8 sep 21
24	Webinar on Design thinking – trigger to Digital transformation	25 Sep 21
25	My Story - Motivational Session by Successful Entrepreneur / CEO of Incubator	25 Sep 21
26	Motivational Session by Successful Entrepreneur	05 Oct 21
27	Incubation and Pre incubation support and different funding schemes	05 Oct 21

**Mini/Major - Innovative student Projects by students with seed money support from Incubation center**

2021 - 22						
Name/Title of the project	Name of the participants	Roll No.	Year of study	Department	Amount Approved (Rs)	Amount funded (Rs)
Drone – Aerial surveillance	Juluri Manish	20R11A0482	II	ECE	30,760	
	Rayaprolu Sujit	19R11A0438	III	ECE		
	Lakshmi Sreya	20R11A0481	II	ECE		
	Ch. Ananya	20R11A0469	II	ECE		
	M. Pooja	19R11A05N1	III	CSE		
	Srikanth P.	20R11A0232	II	EEE		
Drone – for MCEME Hackathon through Robotics Club	Rayaprolu Sujit	19R11A0438	III	ECE	97,515	48,003
	Harsha Vardhan Muddala	19R11A0426	III	ECE		
	Abhishek Bhemisetty	18R11A0554	IV	CSE		
Snake Robot – for	Sunny Raj	19R11A05N4	III	CSE		68,691
	Harshith	19R11A05J4	III	CSE		

PRINCIPAL  
Geethanjali College of Engg. Tech.  
Cheerthi (V), Keesara (M), R.R. Dist. (A.P.) 501 227



MCEME Hackathon through Robotics Club	G.Abhinav	19R11A04M0	III	ECE		
	Oregunta Sai Varun	19R11A0329	III	ME		

Handwritten signature in green ink.

**PRINCIPAL**  
Geethanjali College of Engg. Techn.  
(Cheeryal (V), Kaesera (M), R.R. Dist. (A.P.) - 501301)

## List of Activities for the AY (20-21)

S.No	Event	Date
1	Student Certificates BootCamp	01 Jan 21
2	Webinar on Design Thinking	11 jan 2021
3	Toycathon Student Motivation	20 Jan21
4	NISP Webinar	18 Jan 2021
5	Webinar on IPR "demystifying IPR"	12 Feb2021
6	Workshop on Design Thinking	28 Feb - 2 March 2021
7	Thesis to Business Report	23rd April 2021
8	Innov_Entrep_stu_commy_	26 April 2021
9	WhyIP is IMportant	26 April 2021
10	FacultyAttend_Hack_	22-23 Jun 2021
11	One year celebration of NEP	11 Aug 2020
12	IgniteNominations	2020-2021
13	Mentors Empanelled	Aug 2020-21
14	IEEE Xtreme 14.0	24 Oct 2020
15	National webinar "intellectual property rights"	20 Oct 2020
16	DesignThinking at InstituteLevel	01 Oct 20
17	AnnualReport of IIC	2020-21
18	Hackathons_	2020-21
19	IIC_calaender	2020-21
20	Mini and major project	2020-21
21	Plan of Activities2020 -2021 IIC	2020-21
22	Student participation Summary	2020-21
23	Certificates_InnovationAmbassadors	2020-2021
24	Meet_Resolution IIC	19 Nov 20
25	Minutes_IIC_Council_	19 Nov 20
26	Nom JHuB Accelerator	01 Dec 20
27	Idea pitching competition	12 Dec 20



**PRINCIPAL**

Geethanjali College of Engg. Techn.  
Cheruvu (V), Keesara (M), R.R. Dist. (A.P.) - 501 301



## List of projects for AY (20-21)

2020-21						
Name/Title of the project	Name of the participants	Roll No.	Year of study	Department	Amount Approved	Amount funded
Automated Titrator	M. Sunny Raj	19R11A05N4	II	CSE	32,860	39,772
	G. Abhinav	19R11A04M0	II	ECE		
Red Mud utilisation in the Production of Insulation bricks	Sri Charan	17R11A0105	IV	CE	20,000	10,000
	Ch Kalyani	17R11A0109	IV	CE		
	Vamshi Reddy	17R11A0104	IV	CE		
	Md. Wajjiuddin	17R11A0128	IV	CE		
Smart Electric Vehicle	Ch Sridhar	17R11A0205	IV	EEE	44,000	44,000
	C Yogesh Ram	17R11A0206	IV	EEE		
	Ch. Divya	17R11A0204	IV	EEE		
	A. Venkat Kaoushik	17R11A0201	IV	EEE		
	M Varun	17R11A0231	IV	EEE		
	T Rohit	17R11A0249	IV	EEE		
	V Sanjay	17R11A0251	IV	EEE		
	R Aditya	17R11A0245	IV	EEE		
P Bhargav	17R11A0248	IV	EEE			
Drone (IPAS Challenge)	Pola Sumanth-	18R11A05D1	III	CSE	55,000	5,000
	Sai Krupa Chary Arendra	18R11A0550	III	CSE		
	Abhishek Bhemisetty	18R11A0554	III	CSE		
	T Vishnuvardhan Reddy	18R11A0592	III	CSE		
	G Harshith	18R11A04M0	III	ECE		
	K Vamshi Krishna	18R11A04M8	III	ECE		
	A Harish Kumar Gupta	18R11A0364	III	MECH		
	Srija	18R11A04P8	III	ECE		
	Shivani	18R11A04P7	III	ECE		
	P Sri Satya Harsha	18R11A04P1	III	ECE		
	Arvind Naik	18R11A04C7	III	ECE		
Surface disinfection	B. Abhishek	18R11A0554	III	CSE	4,500	Not yet started
	Sunny Raj	19R11A05N4	II	CSE		
	Oregunta Sai Varun,	19R11A0329	II	MECH		
	Harshith	19R11A05	II	CSE		
Service Robot	B Divya Sai Sathwik	17R11A04A0	IV	ECE	3,80,800* sanctioned on 4th	Ongoing
	G Rashmi	17R11A04B0	IV	ECE		

V Uma Kanth	17R11A04E4	IV	ECE	Dec 2019
Sunny Raj	19R11A05N4	II	CSE	
Oregunta Sai Varun,	19R11A0329	II	MECH	
Harshith	19R11A05E5	II	CSE	

*(Handwritten mark)*

**PRINCIPAL**  
Geethanjali College of Engg. Tech.  
Cheerpal (V), Keerasani (M), S.R. Dist. (A.P.) - 501 301



## List of Activities for the AY (2019-20)

### Workshop / Awareness Programs

S.No	Event	Resource Person	Organization	Target Audience	Date
1	Workshop on Design Thinking	Mr. Abhimanyu Bharadwaj	21ID	Students of 1 <sup>st</sup> year all branches	7/9/19
2	CVA2019 Nominations				30 Sep 2019
3	Workshop on Enhancing all career paths with Entrepreneurship abilities	Mr. Pavan	Metamorphosis	Students of 1 <sup>st</sup> year all branches	6/9/19
4	Workshop on humanoid Robotics	Mr. Pratik Triodkar	Edux Labs	Students of 1 <sup>st</sup> year all branches	9/8/19 – 10/8/19
5	Orientation Program on Innovation and Entrepreneurship	Dr. Anil Puppala Mr. Y.V.N. Phani Kishore	GCET	Students of 1 <sup>st</sup> year all branches	5/8/19, 8/8/19
6	Samasya Workshop	Mr. Y.V.N. Phani Kishore	GCET	Students of 1 <sup>st</sup> year all branches	27/9/19
7	schedule of activities and incubation center at GCET	--	--	<b>Students of all years and all branches</b>	2019-2020
8	Plan of Activities IIC Council of gcet	--	--	<b>Students of all years and all branches</b>	
9	Order From AICTE CVA	--	--	<b>Students of all years and all branches</b>	13 Dec 2019
10	Boot Camp Registrations	--	--	<b>Students of all years and all branches</b>	22 Dec 2019
11	Thank Q Letter From AICTE	--	--	<b>Students of all years and all branches</b>	18 Dec 2019
12	SIH Nom SIH Portal	--	--	<b>Students of all years and all</b>	01 Dec2019



		--		<b>branches</b>	
	Entrepreneurship day celebrations		--	<b>Students of all years and all branches</b>	21 – 24 Dec 19
13	SIH Internal teams	--	--		01 Dec 2019

### Hackathons

S.No	Event	Resource Person	Organization	Target Audience	Date
1	Hackathon – service now	Mr. Sanuj	Service Now	Final Year CSE students	28/8/2019
2	Hackathon – Robotic Process Automation		GCET	<b>Students of all years and all branches</b>	23/12/19 – 24/12/19

### List of Projects for AY 2019-2020

S.No	Name of the Project	Student Details		Status
		Name	Roll No	
<b>Year: 2019-2020</b>				
1	Edupad – A portable tool for blind	L. Venkatesh	16R11A0570	Investor pitch in
		Meghana M.R.	18R11A05M9	
		A.N.S.V.S.L. Krishnaja	18R11A0102	
4	Temporary communication network establishment and surveillance on civilians during natural disaster	A.Jyotishwara Prasad	17R11A05G4	Literature survey in progress. Industry mentor requested
		G.Sai Rohith Vishal	17R11A0462	
		L. Akhila	18R11A0232	
5	Automated Seed Sowing Machine	V. Vinay Kumar	16R11A0594	in
		Pooja M.R.	17R11A0488	
		T. Koushik Choudary	18R11A03A9	
7	Organic Recycler	T. Deeksha	16R11A0589	Work in Progress Design complete
		T. Sri Harshitha	16R11A0588	
		D. Vaishnavi	16R11A0556	
8	Water usage and leakage detection	M.Sri Lekha	18R11A0478	Investor Pitch In
		A.Sai sankeerthana	17R11A0451	

  
**PRINCIPAL**  
 Geethanjali College of Engg. Tech  
 Chittoor, Andhra Pradesh (M), R.R. Dist. 1



### **Achievements / Accomplishments**

1. An idea (Edupad) has been selected by the industry for mentorship and investor support. L L. Venkatesh 16R11A0570
2. Represented Geethanjali with an PoC (Automated seed sowing machine) at CII summit, JHUB – JNTUH for investor's pitch in L. Venkatesh 16R11A0570
3. Organic Recycler has been identified as the innovative project by Texas Instruments and put forward for investor pitch in.
4. An idea (water usage and leakage detection) has been nominated by Ministry of HRD for a Proof of Concept competition at the Central University of Hyderabad.
5. Won 1<sup>st</sup> prize at IEEE CSIS event organized by IEEE – Kerala section at MES College of Engineering
6. 1<sup>st</sup> in Asian Region - Richard E. Mervin student scholarship 2019 was given to a student worth of \$1000.

**PRINCIPAL**  
Geethanjali College of Engg. Tech.  
Cheeryal (Y), Keerasuru (M), R.R. Dist. (A.P.) - 501 30



## List of Activities for the AY (2018-19)

### Workshop / Awareness Programs

S.No	Event	Resource Person	Organization	Target Audience	Date
1	Boot camp on IoT	Mr. Abhishek	Smartbridge Educational Services	Students of 2 <sup>nd</sup> and 3 <sup>rd</sup> year all branches	03/01/2019
2	Boot camp on AI/ML	Mr. Akshay Kumar	Smartbridge Educational Services	Students of 2 <sup>nd</sup> and 3 <sup>rd</sup> year all branches	04/01/2019
3	Design Thinking workshop	Mr. Arvind Saurabh	Tech Mahindra	Students of 1 <sup>st</sup> year all braches	16-/03/2019
4	FDP on Quadcopters	Mr. Bhaskaran	Skyfi Labs	Faculty of CSE,ECE, EEE	04/10/18 – 5/10/18
5	Workshop on Quadcopters	Mr. Sanskaran	Skyfi Labs	Students of 3 <sup>rd</sup> year CSE, ECE, CE	04/10/18 – 5/10/18
6	I Cell Student registrations		GCET	Students of GCET	13/08/2018
7	MHRD Innovation cell		MHRD	Open for all students	13 /10/18

### Hackathons

S.No	Event	Resource Person	Organization	Target Audience	Date
1	Hackathon on Agritech – e – thon	Mr. Jagdish Lolugu	ESCI JNTUH JHUB	Students of 1 <sup>st</sup> , 2 <sup>nd</sup> and 3 <sup>rd</sup> year all branches	05/01/2019-06/01/2019
2	Hackathon on predictive analytics with machine learning and data science using python	Mr. P. Mohan	Tech Mahindra	Students of 1 <sup>st</sup> , 2 <sup>nd</sup> and 3 <sup>rd</sup> year CSE/ECE/EEE	14-16, Mar – 2019

↓

PRINCIPAL  
Geethanjali College of Engg. Tech.  
Cheerthol (V), Keesari (M), S.R. Nagar, Hyderabad

**List of Projects for for AY 2018-2019**



S.No	Name of the Project	Student Details		Status
		Name	Roll No	
<b>Year: 2018-2019</b>				
1	Edupad – A portable tool for blind	L. Venkateszh	16R11A0570	Prototype complete
		Meghana M.R.	18R11A05M9	
		A.N.S.V.S.L. Krishnaja	18R11A0102	
2	Medicinal plant advisor	B. Swamynathan	16R11A0552	Prototype complete
		Nallapati Rashmi	17R11A0433	
		C. Venkata Sri Dikshitha	18R11A0110	
3	e-Farming	Gade Sahithya Kirani	17R11A05L2	Work in Progress Design complete
		J Pallavi	17R11A05L7	
		Ponagati Sekhar Divya Sree	17R11A05M8	
4	Temporary communication network establishment and surveillance on civilians during natural disaster	A.Jyotishwara Prasad	17R11A05G4	Work in Progress Design complete Literature Survey in progress
		G.Sai Rohith Vishal	17R11A0462	
		L. Akhila	18R11A0232	
5	Automated Seed Sowing Machine	V. Vinay Kumar	16R11A0594	Prototype complete
		Pooja M.R.	17R11A0488	
		T. Koushik Choudary	18R11A03A9	
6	E-Bin	S. Ruchiswa	18R11A0490	Work in Progress Design complete
		S. Ramya	18R11A0488	
		M. Vyshnavi	17R11A0235	
7	Organic Recycler	T. Deeksha	16R11A0589	Work in Progress Design complete
		T. Sri Harshitha	16R11A0588	
		D. Vaishnavi	16R11A0556	
8	Water usage and leakage detection	M.Sri Lekha	18R11A0478	Prototype complete
		A.Sai sankeerthana	17R11A0451	

#### Achievements / Accomplishments

1. Won 1<sup>st</sup> and 3<sup>rd</sup> prize at Hackathon 2K19 held at geethanjali (ideas: Solar Powered agricultural robot, Automated irrigation system with solar tracker and moisture sensor)
2. Won 1<sup>st</sup> prize at Hackathon on predictive analytics with machine learning and data science using python (Idea: Air quality monitoring system using ML)
3. Won 1<sup>st</sup> prize at a hackathon conducted at ACE Engineering college (idea: Automated seed sowing machine)
4. Won 1<sup>st</sup> Prize at a hackathon conducted at Kerala ( idea: Automated Seed sowing machine)
5. Won 3<sup>rd</sup> prize at a hackathon conducted at Spoorthy engineering college (idea: low cost crop cutting machine)

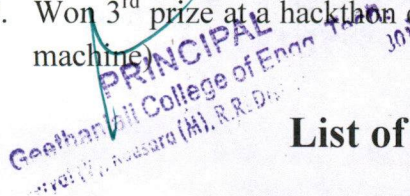
  
 Geethanjali College of Engineering and Technology  
 Mysuru (Kt), R.R. Durgam

#### List of Activities for the AY (2017-18)



### Workshops/ Awareness Programs

S.No	Event	Resource Person	Organization	Target Audience	Date
1	Portal update for the students to join incubation Center	Mr. N. Chandrakanth	GCET	Students of all years and all branches	15/7/17
2	General session on Creativity and Innovation	Mr. N. Chandrakanth / Y.Phani Kishore	GCET	Students of all years and all branches	20/7/17
3	Update Sessions/Discussions	Mr. N. Chandrakanth / Y.Phani Kishore	GCET	Students of all years and all branches	27/7/17
4	Android Application Development Workshop	Mr. Durga Prasad	NSIC	Students of 2 <sup>nd</sup> , 3 <sup>rd</sup> and final years of all branches	12 to 14 August, 2017

### Hackathons

S.No	Event	Resource Person	Organization	Target Audience	Date
1	EXCITE 2K18 – Summer Product training and development	Dr. Vijaya Kumari	J HUB JNTU	15 students from GCET	17-05-18 to 30-6-18
2	J Hub Central Hackathon	Pankaj Divan	JNTU JHUB	10 Students from GCET	15-03-18 to 16-03-18
3	Hackathon 2 K 18	Mr. N. Venkatesh	Redpine Signals	Students of all years and all branches	20-1-18

### List of Projects for AY 2017-18

Sl. No.	Name of Project	Student Details		Status
		Name	Roll No	
1	Sensor based guide for Blind	S. Nagalakshmi Saivenkata Tarun Abhijeet Kumar Ram Kaushik Rahul Sai	15R11A0530 15R11A0479 14R11A04J0 15R11A05J2 15R11A05E7	COMPLETE

  
**PRINCIPAL**  
 Geethanjali College of Engg. Tech.  
 Chennai (T), Chennai (M), R.R. Dist. (A.R.) - 501 000



2	Electricity generation using piezo electricity	Virendranath Santosh Sadiq Madhavi	15R11A0483 15R11A0341 15R11A0350 15R11A0472	COMPLETE.
3	Automated Switch for High beam light in vehicles	B. Thejesh G. Bharath K.J.C. Pavan Kumar P. Grishma D.V.N. Ramya	15R11A0312 15R11A05K5 15R11A0482 15R11A05A0 15R11A05K3	COMPLETE.
4	Automated parking slot Detection System	T. Srikar Pranav Raju B. Kireeti	15R11A0352 14R11A0M6 14R11A0482	COMPLETE.
5	Bicycle Mobile Charger	D.V. Varma Venkat Shreyas Hameed	15R11A0315 15R11A0244 15R11A05B8 15R11A04L5	COMPLETE.
6	SOUND - Generation of power from various sounds	Bharadwaj Vishal Tanmayi Sujana Manikanta	15R11A0314 15R11A0343 15R11A05A5 15R11A0493 15R11A04F2	COMPLETE.
7	Smart Switch	S. Piyush Harshith K.V. Nikhil Shiva Kumar	15R11A0248 15R11A0585 15R11A0168 15R11A05H6	COMPLETE.

### Achievements / Accomplishments

1. Won 1<sup>st</sup> Prize at the Hackathon conducted at Geethanjali on 20-1-18 – (idea – Automated switch for high beam light)
2. Represented geethanjali at JHUB central Hackathon – Ideas have been pitched to investors ( idea- Cylimon)
3. Two projects stood among top 10 represented by various colleges at Excite 2k18 (Idea : Cylimon and Plant watering system)
4. 35 teams have submitted their ideas at Smart India Hackathon

**PRINCIPAL**  
Geethanjali College of Engg. Tech.  
(Coerced (V), Keesara (M), R.R. Dist. 14-01-501 301)

## List of Activities AY 2016-17

S No	List of Events	Resource Person	Organisation	Date
1	General session on Creativity and Innovation	Mr. N. Chandrakanth / Y.Phani Kishore	GCET	15 Apr 2017
2	Update Sessions/Discussions	Mr. N. Chandrakanth / Y.Phani Kishore	GCET	20 Feb 2017
3	UAV Workshop	Mr. Prabhakaran	Aerotrix	22 – 27 May 2017
4	GCET Android App	Dineshwar Sai Rahul ND Saiesh Choudhary	GCET	15 Feb 2017
5	Usage of Raspberry PI	Mr. Subramanyam	GCET	8 Mar 2017

**PRINCIPAL**  
Geethanjali College of Engg. Tech.  
(Cheerla (V), Keeravani (M), R.R. Dist. (A.P.) - 501 301)



# Nominations to SIH 2022

9/23/22, 4:23 PM

College BPOC

Team Leader will get the login credential only after team details got freeze.

Show 100 entries

Search:

Team Details	Team Leader Name	Contact Details	Consent Letter	Idea Status	Action
<b>Name:</b> 88ITS <b>Status:</b> shortlist <b>Category:</b> Software	Shaik Rshidpasha <input type="button" value="View Members"/>	shaikrahidpasha30@gmail.com 6261705669	<input type="button" value="View File (uploads/team_registration_consent_letter/120220330145530.pdf)"/>	View Submitted Idea	Verified
<b>Name:</b> ACCENDO <b>Status:</b> shortlist <b>Category:</b> Software	N Shreya <input type="button" value="View Members"/>	shreyanajamachu@gmail.com 6309381956	<input type="button" value="View File (uploads/team_registration_consent_letter/Dr K Neeraja Shreya20220330142942.pdf)"/>	Idea not submitted yet	Verified
<b>Name:</b> ANVESH <b>Status:</b> shortlist <b>Category:</b> Software	Mohammed Abid Hussain <input type="button" value="View Members"/>	20r11a6730@gcet.edu.in 7675967006	<input type="button" value="View File (uploads/team_registration_consent_letter/Dr20220326102319.pdf)"/>	View Submitted Idea	Verified
<b>Name:</b> CLOUD 09 <b>Status:</b> shortlist <b>Category:</b> Software	T Shaikendra Sainath <input type="button" value="View Members"/>	saikshendra007@gmail.com 6300406620	<input type="button" value="View File (uploads/team_registration_consent_letter/Dr20220326104248.pdf)"/>	View Submitted Idea	Verified
<b>Name:</b> DYNQ <b>Status:</b> shortlist <b>Category:</b> Software	K Dadrinath <input type="button" value="View Members"/>	badrikantkonda12@gmail.com 9063061231	<input type="button" value="View File (uploads/team_registration_consent_letter/20220331145453.pdf)"/>	View Submitted Idea	Verified
<b>Name:</b> GCET ECHO <b>Status:</b> shortlist <b>Category:</b> Software	J.Manish <input type="button" value="View Members"/>	20r11a0482@gcet.edu.in 8013950401	<input type="button" value="View File (uploads/team_registration_consent_letter/111120220329062826.pdf)"/>	View Submitted Idea	Verified

  
**PRINCIPAL**  
 Geethanjali College of Engg. Tech.  
 Cheemuri, Guntur District, Andhra Pradesh - 501307

Team	Team Leader	Name	Contact Details	Action	Idea Status
Software	Category: Software	Name: G Nandini Pava Status: Pending View Members	View File (upload/team_registration_consent_letter/20220328101347.pdf)	View Submitted Ideas	Verified
Software	Category: Software	Name: R Madhavi Sai Status: Pending View Members	View File (upload/team_registration_consent_letter/2022032011502.pdf)	View Submitted Ideas	Verified
Software	Category: Software	Name: Santhi Manjari Status: Pending View Members	View File (upload/team_registration_consent_letter/2022032114304.pdf)	Idea not submitted yet	Verified
Software	Category: Software	Name: Gurni Nandini Status: Pending View Members	View File (upload/team_registration_consent_letter/20220328112047.pdf)	View Submitted Ideas	Verified
Software	Category: Software	Name: Shiksha Devar Status: Pending View Members	View File (upload/team_registration_consent_letter/20220328102617.pdf)	View Submitted Ideas	Verified
Software	Category: Software	Name: B Subanya Status: Pending View Members	View File (upload/team_registration_consent_letter/20220321146216.pdf)	View Submitted Ideas	Verified

✓

PRINCIPAL  
Geethanjali College of Engg. Techn.  
(Theerth (V), Kaveri Taluk, R.R. Dist. (A.P.) - 501 301)



**Winners of 36Hr Hackathon/Competitions held at on the theme 'Robotic Process Automation' in Association with J-Hub - JNTUH 23rd – 24th Dec 2019**

Prize	Name of the Idea	Contact details of the team lead	Email of Team Lead	Dept	Phone No. Of Team Lead
First	Security system with face recognition using openCV and Voice assistance	Jyothiswara Prasad Rajashekar Reddy Y Nikhil Komal Kumar	<a href="mailto:Ajyotish2000@gmail.com">Ajyotish2000@gmail.com</a>	CSE	9705632136
Second	Scrap Collecting Robot	Vinjam Umakanth Alwala Satyanarayana Goud E Naveen G Vinay Kumar	<a href="mailto:Umakanth.vinjam99@gmail.com">Umakanth.vinjam99@gmail.com</a>	ECE	8309535112

  
**PRINCIPAL**  
 Geethanjali College of Engg. Tech.  
 Cheerof (V), Keeravani (M), R.R. Road, (A.P.) - 501301

**Winners of 36Hr Hackathon held at on the theme 'Agritech' in Association with J-Hub - JNTUH 5<sup>th</sup> Jan – 6<sup>th</sup> Jan 2019**

Prize	Name of the Participant	Phone Number	Dept	Email ID	Title of the project
1 <sup>st</sup> Prize	P. Shraddha	7337252127	EEE	shraddha.somu20@gmail.com	Solar powered agricultural robot
	B. Sai Priya	7386288377		priyasai017@gmail.com	
	M. Vyshnavi	9553548725		mssvysh@gmail.com	
	K. Ganesh Kumar	7658967686		kompelliganesh1920@gmail.com	
	G. Lingaiah	9603610570		gugulothulingaiah2000@gmail.com	
3 <sup>rd</sup> Prize	G. Uday Kumar	7207631744		gkuday999@gmail.com	Automated Irrigation with Solar Tracker and Moisture sensor
	B. Gourav Anand	8790552900		bingisamson1998@gmail.com	
	G. Sandeep Varma	9640351101		sandeepvarmagunturi1999@gmail.com	

  
**PRINCIPAL**  
 Goethanjali College of Engg. Tech.  
 Chennarayana (V), Keesara (M), R.R. Dist. (A.P.) - 501 300



**Special mentions/Press coverage:**

Idea	Students	Dept	Roll Numbers	
Edupad – A portable tool for visually handicapped . Won the best idea	L. Venkatesh	CSE	16R11A0570	
Water usage and leakage detection	M.Sri Lekha	ECE	18R11A0478	
	A.Sai sankeerthan a		17R11A0451	
Smart watch – Protective gear  Hyderabad City Police Hackathon	<b>Team lead:</b> <b>Vikas Manchana</b>	Civil	vikas.manchan a@gmail.com	<p>From: <b>hyderabad police hackathon</b> &lt;hydpolicehackathon2019@gmail.com&gt;  Date: Fri, Jan 31, 2020, 3:56 PM  Subject: Congratulations! For being selected in Top 30 teams in the first ever Hyderabad City Police Hackathon.  To: &lt;Vikas.manchan@gmail.com&gt;</p> <p>Dear Team Team Soul,</p> <p>Congratulations! You have been selected as one of the Top 30 teams in the first Hyderabad City Police Hackathon" organised by Hyderabad City Police in collaboration with WI Telangana.</p> <p>The Hackathon saw participation from 99 teams consisting of 4 members each 6 Regions participating in the 36 hour Hackathon held on 18th &amp; 19th January, Bhaskar Reddy Indoor Stadium, Hyderabad. We are happy to mention that you the innovative ideas we received and we look forward to encouraging you to transform into concrete products. To accept your slot, please confirm by acknowledgement before February 6th, 2020.</p> <p>In case of any queries, please feel free to reach out to hydpolicehackathon2019@gmail.com or 9059264664</p> <p>We look forward to hearing and engaging with you.</p> <p>Best Regards</p> <div style="display: flex; justify-content: space-between; align-items: center;"> <div style="text-align: center;"> </div> <div style="text-align: center;"> <p>Shika Goel, IPS  Addl. Commissioner of Police  Hyderabad City Police</p> <p>Deepthi Ravula  CEO, WEHUB</p> </div> </div>

PRINCIPAL

Geethanjali College of Engineering & Technology  
Chagallu (R), Keesara (M), Dist. Nellore

Date: 31/01/2020



Prize	Event	Name of the participant	Roll Numbers	Dept	Phone of team lead	Email ID of team lead	Project Title
First Prize	36 Hr Hackathon at ACE Engineering College, Hyderabad 18-19 Jan 2019	Lagishetti Venkatesh	16R11A0570	CSE	7981476225	venkatesh.vhyd@gmail.com	Automated Seeded Sowing machine
		B. Swamynathan	16R11A0552				
		V. Vinay	16R11A0594				

<p>HemCrete: A replacement for concrete bricks.</p> <p>Shortlisted and participated in national level National level Chaatra Vishwakarma Awards.</p> <p>They third place narrowly</p>	<p><b>Team Lead: Aravelli Sri Charan</b></p>	<p>Civil</p>	<p><a href="mailto:aravellisricharan@gmail.com">aravellisricharan@gmail.com</a></p>	<p>From: no-reply &lt;admin@aicte-india.org&gt;  Date: Thu, 28 Nov, 2019, 10:47 AM  Subject: Selection for Regional Convention of AICTE-Chhatra Vishwakarma Awards for the  To: &lt;aravellisncharan@gmail.com&gt;</p> <p>Dear Students,</p> <p>This is to inform you that your prototype has been selected for participation in Regional Convention of AICTE-Chhatra Vishwakarma Awards for the year 2019. List of selected Teams has also been uploaded on AICTE website at  <a href="https://www.aicte-india.org/sites/default/files/Shortlisted%20Teams%20after%20evaluation%202019.pdf">https://www.aicte-india.org/sites/default/files/Shortlisted%20Teams%20after%20evaluation%202019.pdf</a></p> <p>Your Team will be called for Practical Demonstration of the proposed solution at your respective Regional Office of AICTE, as per Rules.</p> <p>The travel expenses of the participating team &amp; faculty in-charge for participation in Regional Convention of AICTE, as per Rules.</p> <p>The selected Teams from the Regional Convention will be called for National Convention at Hyderabad.</p> <p>Regards,  AICTE</p>
---	--	--------------	---	---

**PRINCIPAL**  
Geethanjali College of Engrg. Tech.  
Vijaya Vittala (M), R.R. Dist. (A.P.) - 501 301



Second Prize	“Robothon5.0” in IEEE Robotics and Auotmation Society student Branch Chapter Chenganur college of Engineering (Kerala). 22-24 Feb 2019	Kumar					
--------------	---	-------	--	--	--	--	--

### Winners of Internal Hackathon SIH 2020

Idea	Team ID	Student Name	Dept	Roll Number	Phone No. of Team Lead	Prize
Air-Cleansing Tower	S-21	Sowjanya Korna	ME	17R11A0324	7013145011	I
		N.K. Udbhav	ME			
		B. Vaishnavi devi	ECE	17R11A04F3		
		Aditya Dash	ME			
Firefighting Robot	S14	M. Vyshnavi	EEE	17R11A0235	7337252127	II
		P. Shraddha	EEE	17R11A0246		
		Vaibhav jaiswal	EEE			
		B. Shravani	EEE			
	S-40	K. Sai Sanjana	EEE		8008101874	III
		Rahul Kumar	EEE			
		K. Navya Sree	EEE			
		K. Sree Sai bhavana	EEE			

4

**PRINCIPAL**  
Geethanjali College of Engg. Tech.  
Cheerayal (V), Kozhikode - 686 011, K.A. Dist. (A.P.) 501 307



**Consolidated:** Awards won by students of Geethanjali College at State and National level competitions:

Winners/Awardees:

S. No.	Prize	Name of the Participant	Title of the project	Event Name
1	1 <sup>st</sup> Prize	P. Shraddha	Solar powered agricultural robot	36Hr Hackathon held at GCET in collaboration with JHuB JNTUH on Jan 5-6, 2019
		B. Sai Priya		
		M. Vyshnavi		
2	3 <sup>rd</sup> Prize	G. Uday Kumar	Automated Irrigation with Solar Tracker and Moisture sensor	
		B. Gourav Anand		
		G. Sandeep Varma		
		K. Rafeuddin		
		K. Meghana Sai		
		Ramya Teja		
3	First	Myson Sunny Raj	Surface Disinfection systems	Innovation Challenge by JHuB, JNTUH, Telangana state level
4	First	Jyotishwara Prasad	Security system with face Recognition using open cv and voice assistance	36Hr Hackathon held at GCET in collaboration with JHuB JNTUH during Dec 23-24, 2019
		RajaShekar Reddy		
		Y Nikhil Komal Kumar		
		DeneshwaraSai		
5	Second	Vinjam Umakanth	Scrap collecting Robot	
		Alwala Suryanarayana		
		Alwala Suryanarayana Goud		
		E Naveen		
		G Vinay Kumar		
6	Second	Lagishetti Venkatesh	Automated Seed Sowing machine	"Robothon5.0" in IEEE Robotics and Auotmation Society student Branch Chapter Chenganur college of Engineering (Kerala). 22-24 Feb 2019
		B. Swamynathan		
		V. Vinay Kumar		
7	Third	Lagishetti		36 Hr Hackathon

PRINCIPAL  
Geethanjali College of Engg. Techn.  
Choorayal (V), Keosara (M), R.R. Dist. (A.P.) - 501 307



	Venkatesh		at ACE Engineering College, Hyderabad 18-19 Jan 2019
	B. Swamynathan		
	V. Vinay Kumar		
	Lagishetti Venkatesh		

### Recognition/Laurels

#### Shortlisted /selected for the next stage of participation:

S. No	Project Name	Student	Event
1	Hempcrete	Aravelli Sri Charan	Chaatra vishwa karma awards 2019
		Cherukuri Kalyani	Shortlisted to present at National level New Delhi
2	Hempcrete	Aravelli Sri Charan	Innovation Challenge 2021 – JhuB JNTUH
3	Floor cleaning robot	Bandi Akhil	
4	ASVR Solutions	Aditya Meka	
5	Electricity from Rain Water	K.V. S. Sai Ram	
6	Surface Disinfection systems	Myson Sunny Raj	
		Harshith Varma	
		Varun	
		Abhishek	
7	Flower knitting machine	Oreganti Sai Varun	Chaatra vishwa karma awards 2020. Shortlisted to participate at next level.
		Sri Harsha Vema	
		Chnaspb Srinivas	
8	Vrikorder.com; An app for delivery of food	Vempati Aravind	
		Ravulakollu Narender	
		Yarlagadda Shriram	
		RajaRaman Ameeta	
9	Automated seed sowing machine	Lagishetti Venkatesh	36 Hr Hackathon at ACE Engineering College, Hyderabad 18-19 Jan 2019
		B. Swamynathan	
		V. Vinay Kumar	
10	Smart watch – Protective gear	Team lead: Vikas Manchana	36-Hr, Hackathon held during Jan 18-19, 2020 held by Hyderabad



			City Police and Woman Entrepreneurs association of Hyderabad; Selected as one of the top 30 teams; organized by
--	--	--	---

### Details of competitions participated during 2017-2021

Chaatra Vishwakarma Awards 2019, 2020	2
SIH 2018, 2019	2
JHuB League of Hackathons 2018-19, 2019-20	10
JHuB Innovation Challenge	1
IEEE Robotics Hackathon Kerala 2019	1
MCEME - Military college of Engineering Hackathon Dec 2021	1
International Planetary Aerial Systems Challenge 2021	1
Society of Automotive Engineers India SAE India 2018,2019	2
Total	20

### Summary of student participation, projects

	Number of IIC Activities	Number of Projects seed funded	Number of projects realized including projects funded	Total Students
2021- 22*	19	3	189	685
2020-21	22	6	27	132
2019-20	6	5	53	205
2018-19	9	7	34	662
2017-18	4	5	25	72
2016-17	5	2	7	30

\*On Going

More Information can be accessed from the Incubation Center's webpage at <https://gcet-incubation.web.app/>

#### Contact Details

[incubation@gcet.edu.in](mailto:incubation@gcet.edu.in)

PRINCIPAL  
Geethanjali College of Engg. Tech.  
Changanassery, Kollam (A.P.) - 501 301





# Geethanjali College of Engineering and Technology

(UGC Autonomous)

(Accredited by NAAC with 'A' Grade & NBA, Approved by AICTE and Permanently Affiliated to JNTUH)

Cheeryal(V), Keesara(M), Medchal Dist., Telangana State – 501 301.

## Report of

### A webinar on “Innovations & Entrepreneurship among students community”

#### 1. Need Analysis

Currently, higher education plays an important role in developing *Innovations & entrepreneurship* among students. As this is an additional requirement of 21<sup>st</sup> century students, academicians must understand its importance to guide them in that direction. Considering this as a part of curriculum teachers must involve and lead the students to develop their skills towards innovation and entrepreneurship. Based on the above, there is a need to understand the importance of Innovations & Entrepreneurship among students community. Hence, a webinar session is planned by Institute’s Innovation Council of Geethanjali College of Engineering and Technology in the month of March 2021.

#### 2. Details of the webinar:

**Title:** *How to Manifest Innovation & Entrepreneurship Ecosystem in the Student Community and Protection of IP for Innovations*

**Date:** 26-03-2021 (Friday)

**Time:** 2:00 PM to 3:30 PM

**Google Meet link:** <https://meet.google.com/ava-yjsz-trf>

**Resource Person:** Dr. M. K. Kaushik, CEO-VIBA (Vaagdevi Incubation and Business Accelerator)

**No. of Participants:** 103

**Target Audience:** Participants from different departments joined the webinar session

#### The speaker focused on the following topics:

- Discussed about the innovations in India and the position of India in global ranking w.r.t. innovations and start-ups
- Discussed about aspiration of Indian innovations by 2024

PRINCIPAL  
Geethanjali College of Engg. Tech.  
Cheeryal (V), Keesara (M), R.R. Dist. (A.P.) - 501 301

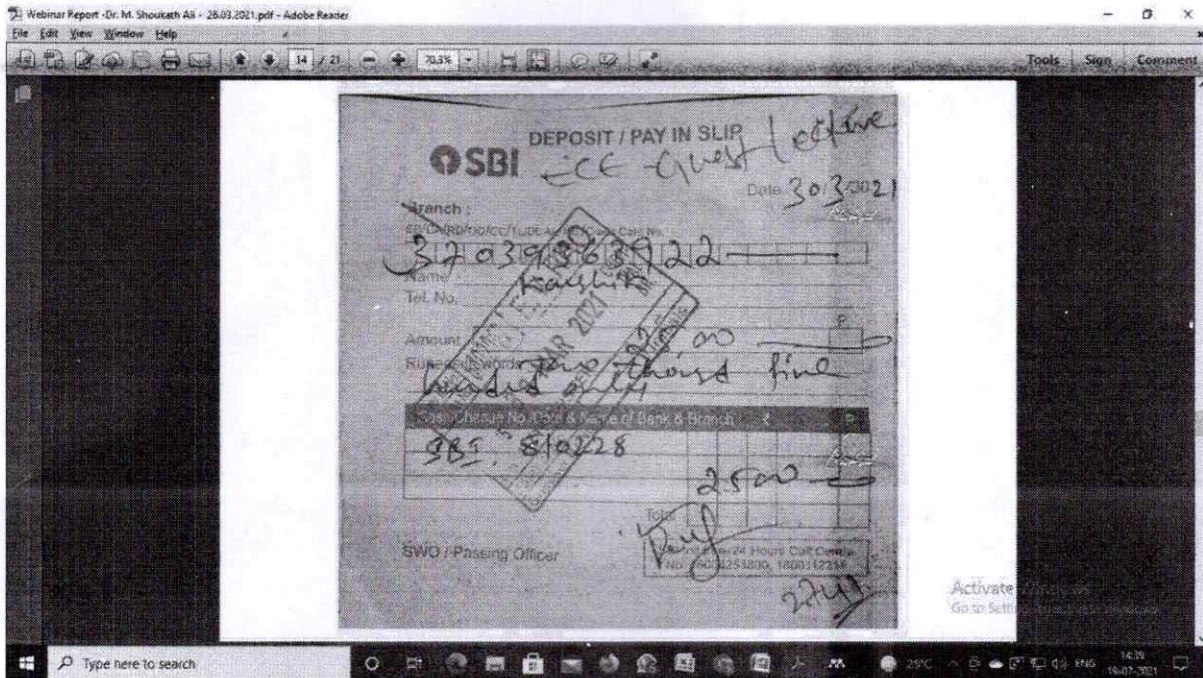

### 3. Invitation Brochure

**A Webinar on**

***“How to Manifest Innovation & Entrepreneurship Ecosystem in the Student Community and Protection of IP for Innovations”.***



**Speaker:**  
**Dr. M. K. Kaushik**  
CEO - VIBA

Date: 26-03-2021 & Time: 2:00 PM to 3:30 PM  
Link: <https://mcet.google.com/ava-yjsz-trf>

**Department of Electronics & Communication Engineering**  
**Geethanjali College of Engineering and Technology**

Accredited by NAAC with 'A' Grade & NEA. Approved by AICTE and Affiliated to JNTUH  
Cheeruvu (V), Keeravaram (M), Mettupalayam Dist. TS - 501 301.

### 4. Photos

**PRINCIPAL**  
 Geethanjali College of Engg. Tech.  
 Cheeruvu (V), Keeravaram (M), R.R. Dist. (A.P.) - 501 301



1	ogirala.sivakumar@gmail.com	Mr.	OVPR Sivakumar	GCET
2	pvijaibhaskar@gmail.com	Dr.	P.Vijai Bhaskar	GCET
3	boddusuneetha1710@gmail.com	Mrs.	B. Suneetha	Geethanjali College of Engineering and Technology
4	sathyavemuri@gmail.com	Dr.	Satya srinivas Vemuri	Geethanjali college of Engineering and technology
5	vallisree.ece@gcet.edu.in	Dr.	S.Vallisree	Geethanjali College of Engineering and Technology
6	jyothi.ece@gcet.edu.in	Mrs.	S. Jyothirmaye	Geethanjali College of Engineering and Technology
7	dvrreddy1@gmail.com	Mr.	D Venkata Rami Reddy	GCET
8	harikumar.ece@gcet.edu.in	Mr.	HARI KUMAR BUDHAVARAPU	Geethanjali College of Engineering and Technology
9	aadharisanthosh.me@gcet.edu.in	Mr.	AADHARI SANTHOSH	GEETHANJALI COLLEGE OF ENGINEERING AND TECHNOLOGY HYDERABAD
10	rsudarshan.me@gcet.edu.in	Mr.	Rikka Sudarshan	Geethanjali College of Engineering and Technology, Hyderabad
11	laxmireddyperam.me@gcet.edu.in	Mr.	Peram Laxmireddy	Geethanjali College of Engineering and Technology
12	bhaskerb9.me@gcet.edu.in	Mr.	Bhasker.Bommera	Geethanjali College of Engineering and Technology, Hyd.
13	shainaz.mba@gcet.edu.in	Mrs.	Mrs.SHAINAZ BEGUM	Geethanjali college of engineering and technology
14	apsjyothi.mba@gcet.edu.in	Mrs.	Parvathi Siva Jyothi Bhogadi	Geethanjali College of Engineering and Technology
15	satyamech343@gcet.edu.in	Mr.	P Satyanarayana	GCET Hyderabad
16	kvenkatesh.me@gcet.edu.in	Mr.	KOLUSU VENKATESH	Geethanjali College of Engineering and Technology

PRINCIPAL  
Geethanjali College of Engg. Tech.  
Cheeryal (V), Kaasara (M), R.R. Dist. (A.P.) - 501 25

33	kshashanka.mba@gcet.edu.in	Mrs.	k shashanka	Geethanjali College of Engineering Technology
34	katkamsrinu@gmail.com	Dr.	Srinivas Katakam	Geethanjali College of Engineering and Technology
35	sprcbtech07@gmail.com	Mr.	S POORNA CHANDER RAO	GEETHANJALI COLLEGE OF ENGINEERING AND TECHNOLOGY
36	mbahod71@gmail.com	Dr.	J. Pardha Saradhi	Geethanjali College of Engineering and Technology
37	vittam.raki2@gmail.com	Mr.	Vittam Rakesh	Geethanjali College of Engineering and Technology Cheeryal keesara Medchal Hyderabad
38	hasinifromasia@gmail.com	Mrs.	Naga Suhasini V.	Geethanjali college of Engineering and Technology
39	masadiprashanth@gmail.com	Mr.	M. PRASHANTH KUMAR	Geethanjali college of engineering and technology(Autonomous)
40	banitha.me@gcet.edu.in	Mrs.	B. Anitha	Geethanjali college of Engineering and Technology
41	drshoukathali.ece@gcet.edu.in	Dr.	M. Shoukath Ali	Geethanjali College of Engineering and Technology
42	surasapthagiri.me@gcet.edu.in	Dr.	Sura Sapthagiri	Geethanjali College of Engineering and Technology
43	ravikanth.mba@gcet.edu.in	Mr.	Ravikanth Thogarcheti	Geethanjali College of Engineering and Technology
44	umarani.ece@gcet.edu.in	Mrs.	M.UMARANI	Geethanjali College of Engineering and Technology
45	gopagonipraveen@gmail.com	Mr.	PRAVEENKUMAR GOPAGONI	Geethanjali College of Engineering and Technology
46	sitamadhavi.mba@gcet.edu.in	Dr.	A Sita Madhavi	Geethanjali College of Engineering and Technology
47	annedachandrakala@gmail.com	Mrs.	A.chandrakala	Geethanjali college of engineering and technology

**PRINCIPAL**  
 Geethanjali College of Engg. Tech.  
 Cheeryal (V), Keesara (M), A.R. Dist. (A.P.)



64	anushareddy.kallem@gmail.com	Mrs.	K.Anusha	GEETHANJALI COLLEGE OF ENGINEERING AND TECHNOLOGY
65	monika.cse@gcet.edu.in	Mrs.	A MONIKA	Geethanjali college of engineering and technology
66	naupal.mba@gmail.com	Mr.	Mr.K.Naupal Reddy	Geethanjali College of Engineering and Technology
67	murali.krr@gmail.com	Mr.	Murali karri	Geethanjali college of engineering and technology
68	gumadevi.cse@gcet.edu.in	Mrs.	G. Uma Devi	Geethanjali college of engineering and technology
69	naresh.kosuri@gmail.com	Mr.	Kosuri naresh babu	Geethanjali college of engineering and technology
70	santoshkumar.cse@gcet.edu.in	Mr.	Santhosh Kumar	Geethanjali college of engineering and technology UGC-AUTONOMOUS Hyderabad
71	gumadevi.cse@gcet.edu.in	Mrs.	G Uma Devi	Geethanjali College of engineering and technology
72	rajesh5479.cse@gcet.edu.in	Dr.	Rajesh Kumar Shrivastava	Geethanjali College of Engineering and Technology, Hyderabad
73	mkeerthi.cse@gcet.edu.in	Ms.	KEERTHI MANCHIKANTI	Geethanjali College Of Engineering and Technology
74	narrirajendar.me@gcet.edu.in	Mr.	N Rajendar	Geethanjali college of engg and Tech
75	kunchala324@gmail.com	Mr.	K RAJU	GCET
76	lavanyamaguluri@gmail.com	Mrs.	Lavanya Maguluri	Geethanjali college of engineering and technology
77	rajmohan_st@yahoo.com	Mr.	S T Rajmohan	Geethanjali College of Engineering & Technology
78	upendermaloth@gmail.com	Dr.	Maloth Upender	Geethanjali College of Engineering and Technology
79	neerajarani@gmail.com	Dr.	Gaddipati Neeraja Rani	Geethanjali College of Engineering and Technology

Geethanjali College of Engg. Tech.  
Cheerl (V), Keesara (M), R.R. Dist. (A.P.) - 501 301

				technology
96	suresh.ece@gcet.edu.in	Mr.	Ch Suresh Kumar	Geethanjali college of engineering and technology
97	manjulavijayagiri@gmail.com	Mrs.	V Manjula	Geethanjali College of Engineering and Technology
98	nemani.subhadra@gmail.com	Dr.	NEMANI SUBADRA	Geethanjali College of Engineering and Technology
99	bnsreekar28@gmail.com	Dr.	Nagamani Balantrapu	Geethanjali College of Engineering and Technology
100	blprakash.ece@gcet.edu.in	Dr.	B.L.Prakash	Geethanjali College of Engg and Technology
101	kniranjankumar.me@gcet.edu.in	Mr.	KATIKANI NIRANJAN KUMAR	GEETHANJALI COLLEGE OF ENGINEERING AND TECHNOLOGY
102	swathibacharaju.cse@gcet.edu.in	Dr.	B. V. Swathi	Geethanjali college of Engineering and Technology
103	spandana.ece@gcet.edu.in	Dr.	P. Spandana	Geethanjali college of Engineering and Technology



## Geethanjali College of Engineering and Technology

UGC Autonomous

Report on A Three Day Workshop on Design Thinking and Critical Thinking

28-02-2021 to 2-03-2021

### **Pre Workshop:**

The idea of conducting a workshop to provide hands on experience to the students started on Jan 7<sup>th</sup>, 2021. The resource person was identified and after seeking the necessary approval from the college authorities, the dates of the workshop were fixed keeping in mind the availability of the resource person and our academic calendar.

Then after a series of discussions with the resource person over phone, we felt that providing self learning material to the students before attending the workshop will be advantageous, as the students can spend more time in working during the three days of workshop.

Later, 100 students were selected based on their enthusiasm to work on projects Principal and HoD, addressed all the selected students on 5<sup>th</sup> February, 2021 through an online meet from 6.15 p.m to 6.45 p.m.

Multidisciplinary teams consisting of 5 members in a team were formed and they were informed to browse various problem statements available on AICTE, UGC and other MNC websites. In addition, they were also advised to observe meticulously for identifying new problem statements.

The resource person, Dr.Bala Ramadurai, Professor at NPTEL, SIBM Pune shared 16 Youtube videos and three assignments for the students. To make this happen, the students were asked to join the Google Meet from 16<sup>th</sup> February to 20<sup>th</sup>, 2021 from 6.30 p.m to 7.45 p.m.

Students were given a week's time to discuss and identify problem statements. Teams 1 to 10 presented their problem statements on 22<sup>nd</sup> February, teams 11 to 20 presented their problem statements on 23<sup>rd</sup> February from 6.00 p.m to 8.30 p.m.

### **During the workshop:**

All the students actively and enthusiastically participated in the workshop. The pre-learning sessions helped them to understand the concepts easily and facilitated more time to work on their problem statements and more time and opportunity to interact with the resource person. On the last day of the workshop many teams have either completed doing a website or half way through an app or made a prototype.

Mr. Santosh of Mechanical Engineering Department who was identified from the department has extended a lot of support and cooperation.

  
**PRINCIPAL**  
Geethanjali College of Engg. and Tech.  
Cheeryal (V), Keesara (M), Medchal Dist.(T.S.)-501 301.

**For the last question on any suggestions.....sample responses are given below:**

- Nothing...but I was disappointed that we meet sir through virtual meeting...
- If it was a direct meet in the work shop it would be more nice
- No . Everything was good .
- It was an amazing workshop. Only problem : conducted during exam time.
- Improvement of intercom and wifi
- Need as much help as possible from faculty to develop our project
- Session was mind blowing
- Every inch was perfect but, offline would have been more fun.

Coordinator(s)

Dr.B.Nagamani-Associate Professor of English

Ms.V.Manjula- Assistant Professor of Physics

P.S: Photographs are added in the next page.

  
**PRINCIPAL**  
Geethanjali College of Engg. and Tech.  
Cheeryal (V), Keesara (M), Medchal Dist.(T.S.)-501 301.



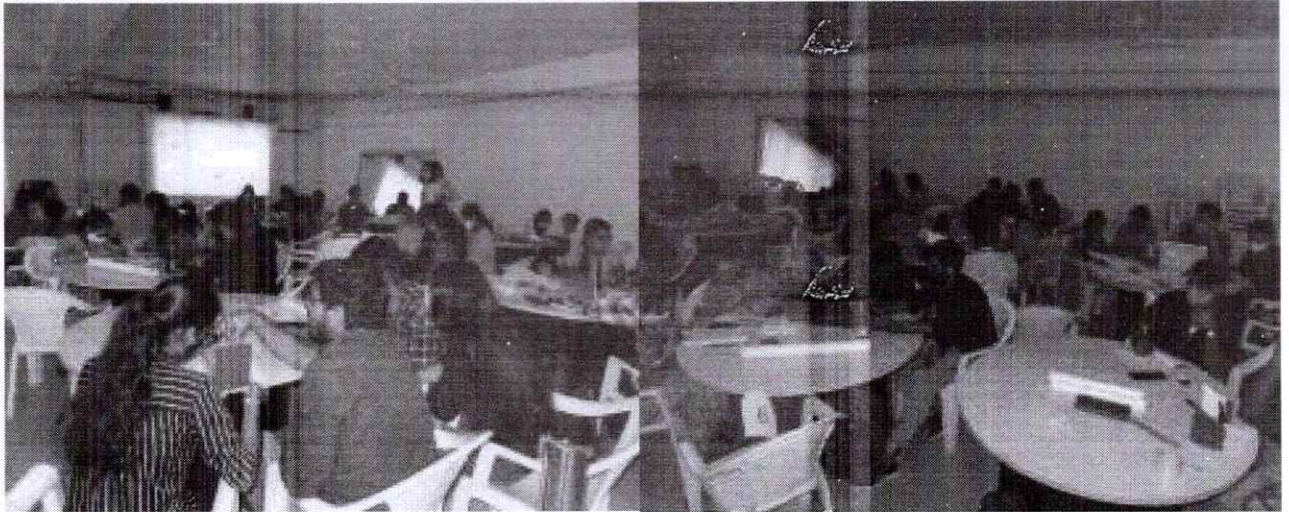

As busy as bees.

Teams at work

**PRINCIPAL**  
**Geethanjali College of Engg. and Tech.**  
**Cheeryal (V), Keesara (M), Medchal Dist.(T.S.)-501 201.**



# Geethanjali College of Engineering and Technology

(UGC Autonomous Institution Accredited by NBA & NAAC,  
Permanently Affiliated to JNTUH, ISO 9001:2015 certified)  
Cheeryal (V), Keesara (M), Medchal. Dist. 501301



Report  
Webinar on

***“How to plan for Start-up - legal, Ethical Steps and  
financial aspects”***

On 8<sup>th</sup> Sept 2021

**Resource Person:**

**Ms. J. Roopali**

Chartered Accountant,  
Qualified in the year 1998  
Lakshmi Nallamilli & Co.,

**PRINCIPAL**  
Geethanjali College of Engg. and Tech.  
Cheeryal (V), Keesara (M), Medchal Dist.(T.S.)-501 301.



<https://drive.google.com/file/d/12H65cHA2XmW2F-lKgUMM9JJFFWZZOuoi/view?usp=sharing>

**Gallery  
Online:**

REC L LNCO CA firm is presenting

**Step 1: Personal Evaluation**

Question yourself??

What do you want?....fame, money, comfort

What are your qualities??

What is your skill set??

What is your risk appetite??

Would you want to provide a service or a product??

People

- Mute all
- Add people
- Host controls
- Saganti Muneender
- Sai
- shriya JM
- Sumanth
- Tejas
- UDDALA SREEKANTH GC...

LNCO CA firm | P SATYANARAYA... | 20 others | You

2:13 PM | Industry Interaction

LNCO firm profile....pdf | Internship Certifica....pdf

2:13 PM 9/8/2021

*Sre*  
**PRINCIPAL**  
Geethanjali College of Engg. and Tech.  
Cheeryal (V), Keesara (M), Medchal Dist.(T.S.)-501 301.

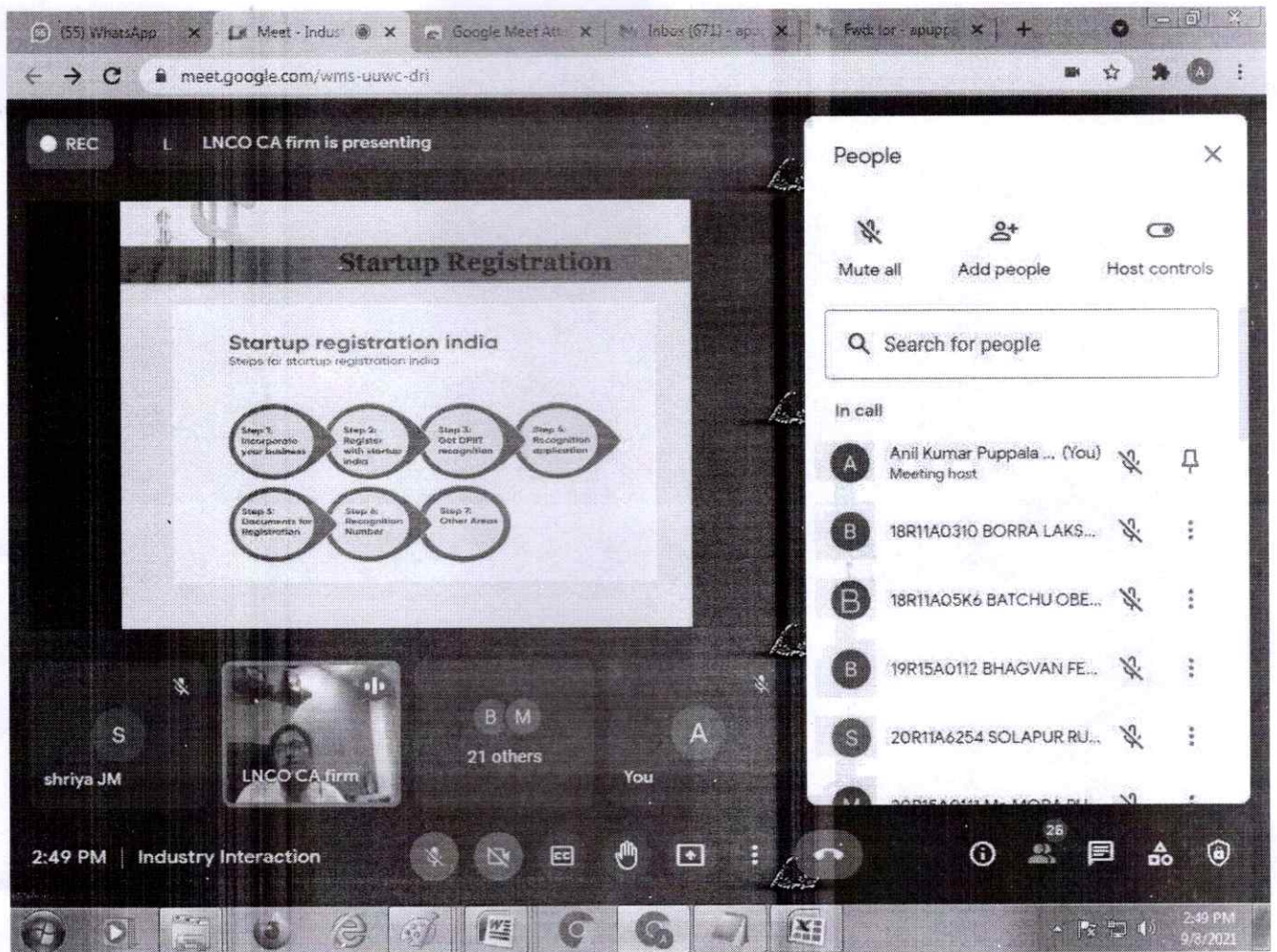

Pictures of  
Offline : live streamed in the class room

*Siv*  
PRINCIPAL  
Geethanjali College of Engg. and Tech.  
Cheerla (V), Kosuru (M), Medchal Dist.(T.S.)-501 301.



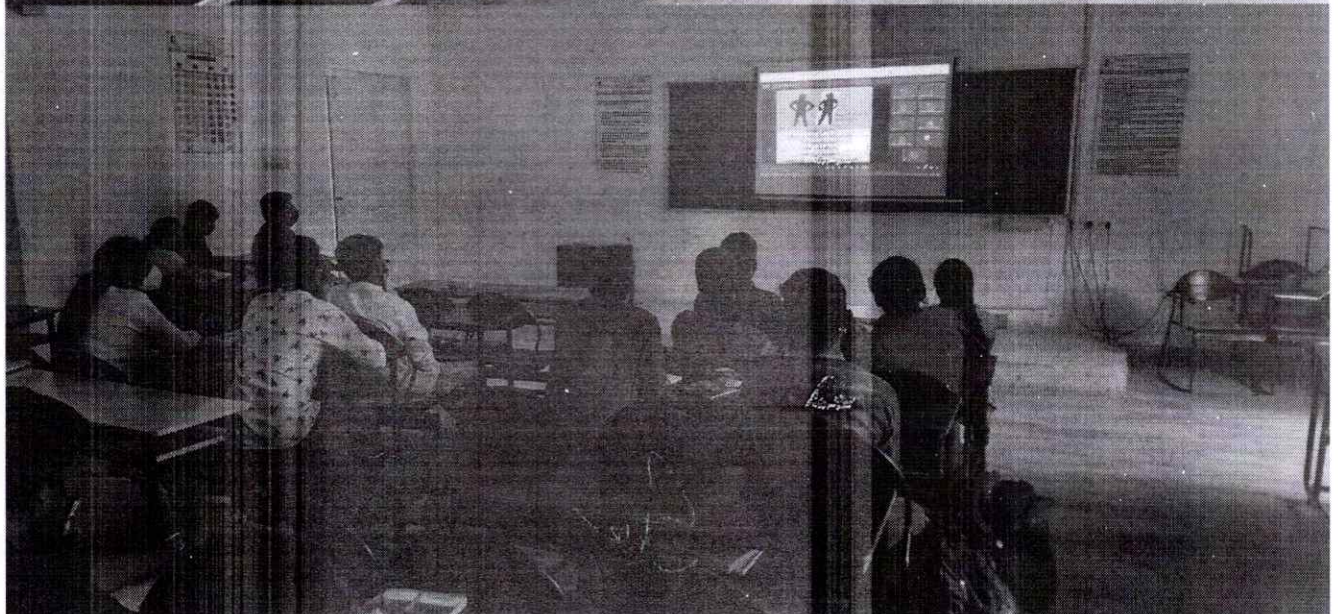
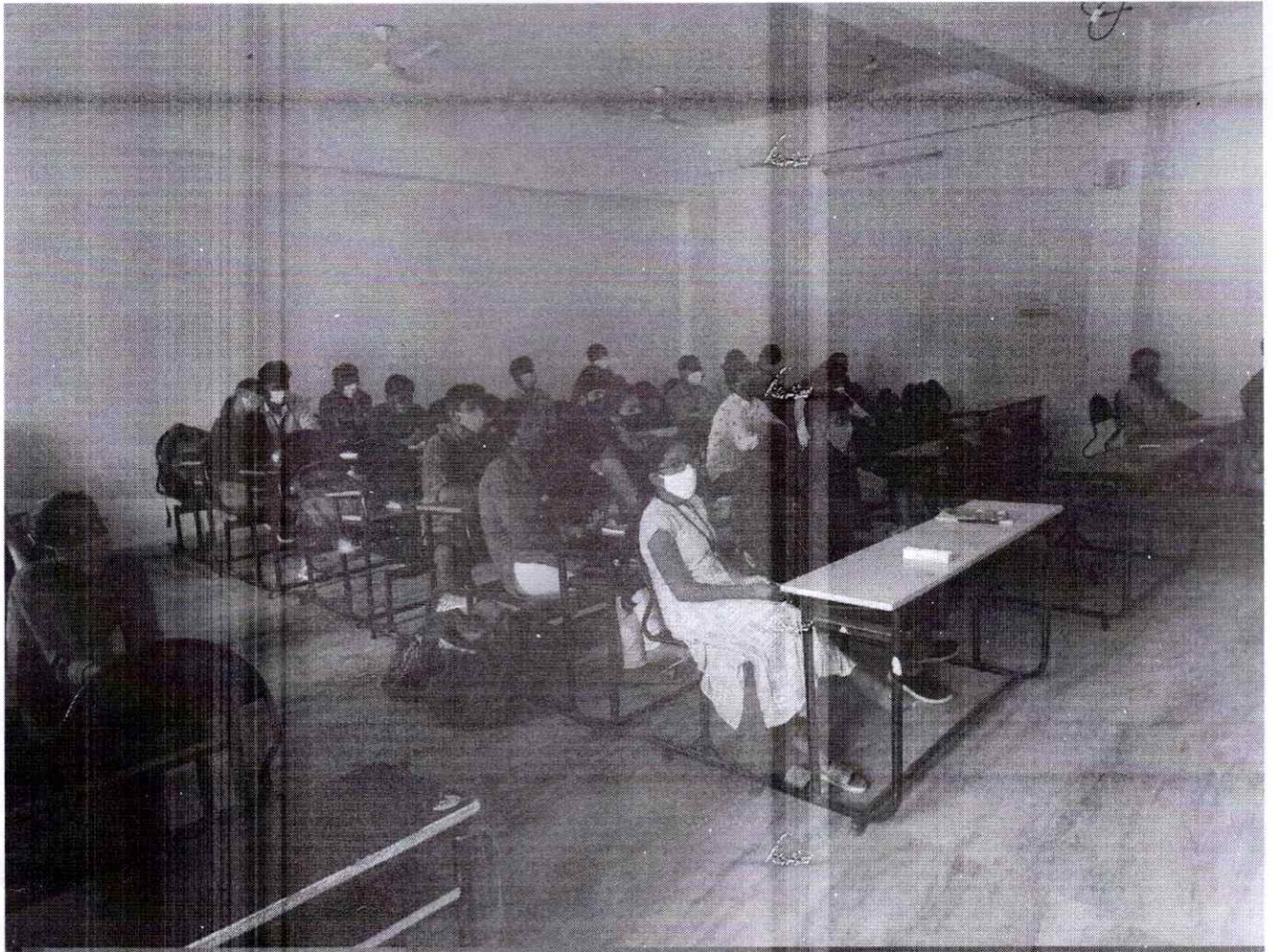

**PRINCIPAL**  
Geethanjali College of Engg. and Tech.  
Cheeryal (V), Keesara (M), Medchal Dist.(T.S.)-501 301.





# Geethanjali College of Engineering and Technology

CHEERYAL (V), KEESARA (M), Medchal DIST-501301, Telangana

## Report

### Training of Startups Registered at GCET's Incubation Center for Business Model Competition

#### Objective:

One of the incubators (JHuB/JLABs) situated Jawaharlal Nehru Technological University Hyderabad(JNTUH), a section 8 registered incubator sponsored by Telangana State Government is organizing Investor pitching competition on 21<sup>st</sup> Aug 2021. **Incubation Center located at Geethanjali college of Engineering and Technology, has invited proposals from it's students and shortlisted the entries and in collaboration with JHuB is facilitating and training the startup companies registered at GCET's incubation center and also entrepreneurs who are alumni of GCET to be able to pitch before the investors called as JVEN Shark Tank event.**

GCET is regularly conducting workshops to help them attain series A funding from the investors.

**Number of STARTUP companies benefitted: 5**

Names of the startup companies nominated by GCET's incubation cell

Company Name	Signatory Authority	CIN Number	Website Address
--------------	---------------------	------------	-----------------

PRINCIPAL  
Geethanjali College of Engg. Tech.  
Cheeryal (V), Keesara (M), R.R. Dist. (A.P.) - 501301.



<https://twitter.com/geethanjalites/status/1417211199255564304/photo/2>



**JVEN SHARKTANK**

AUGUST 21, 2021



**LAST  
DAY  
TO  
APPLY!**

Reminder note:

Dear Heads of J Labs/Faculty Coordinators,

Greetings from Team J-Hub!

Applications are invited for Entrepreneurs in JLABS or Alumni for participation in JVEN SHARKTANK EVENT scheduled in August 2021.

Nominations may be send by the following link

<https://forms.gle/vK499ykkumCDWoeQ7>

The last date for nominating applications is 24th July 2021

10:49

**Training sessions** given by Innovation Ambassadors of GCET so that student startups will be able to properly pitch their Business models

**Link to Video Recordings**

**of the training sessions for the startups registered at our incubation center.**

<https://drive.google.com/file/d/1Pv0FiBq3FpAPbVgVHOWYCKe1UkdQE3lr/view?usp=sharing>

**PRINCIPAL**  
Geethanjali College of Engg. Tech.  
Keesarabadi (T), Keesarabadi (M), R.R. Dist. (A.P.) - 501 904

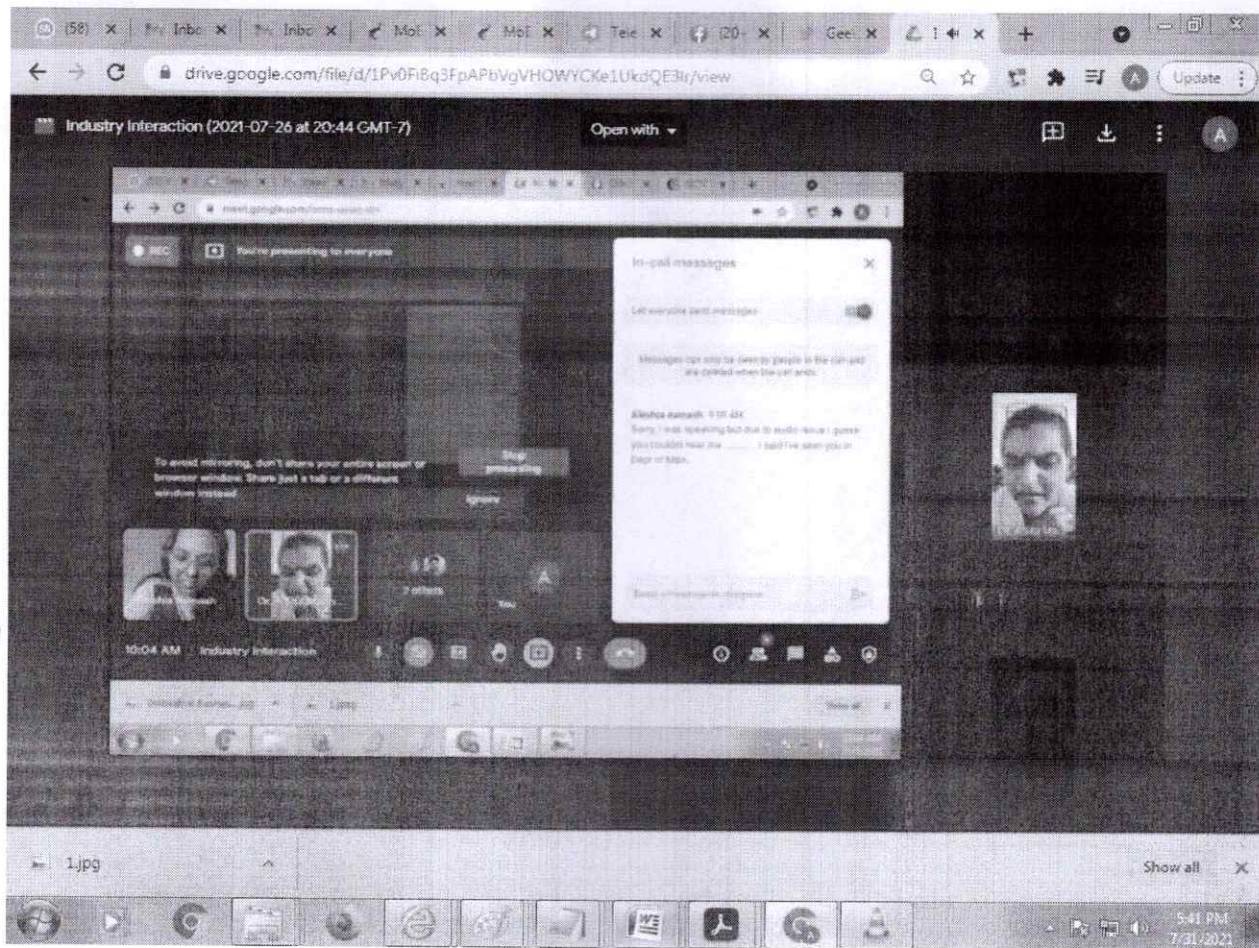

*[Handwritten signature]*

PRINCIPAL  
Geethanjali Collage of Engg. Tech.  
Cheerpal (Y), Kessara (M), R.R. Dist. (A.P.) - 501 304



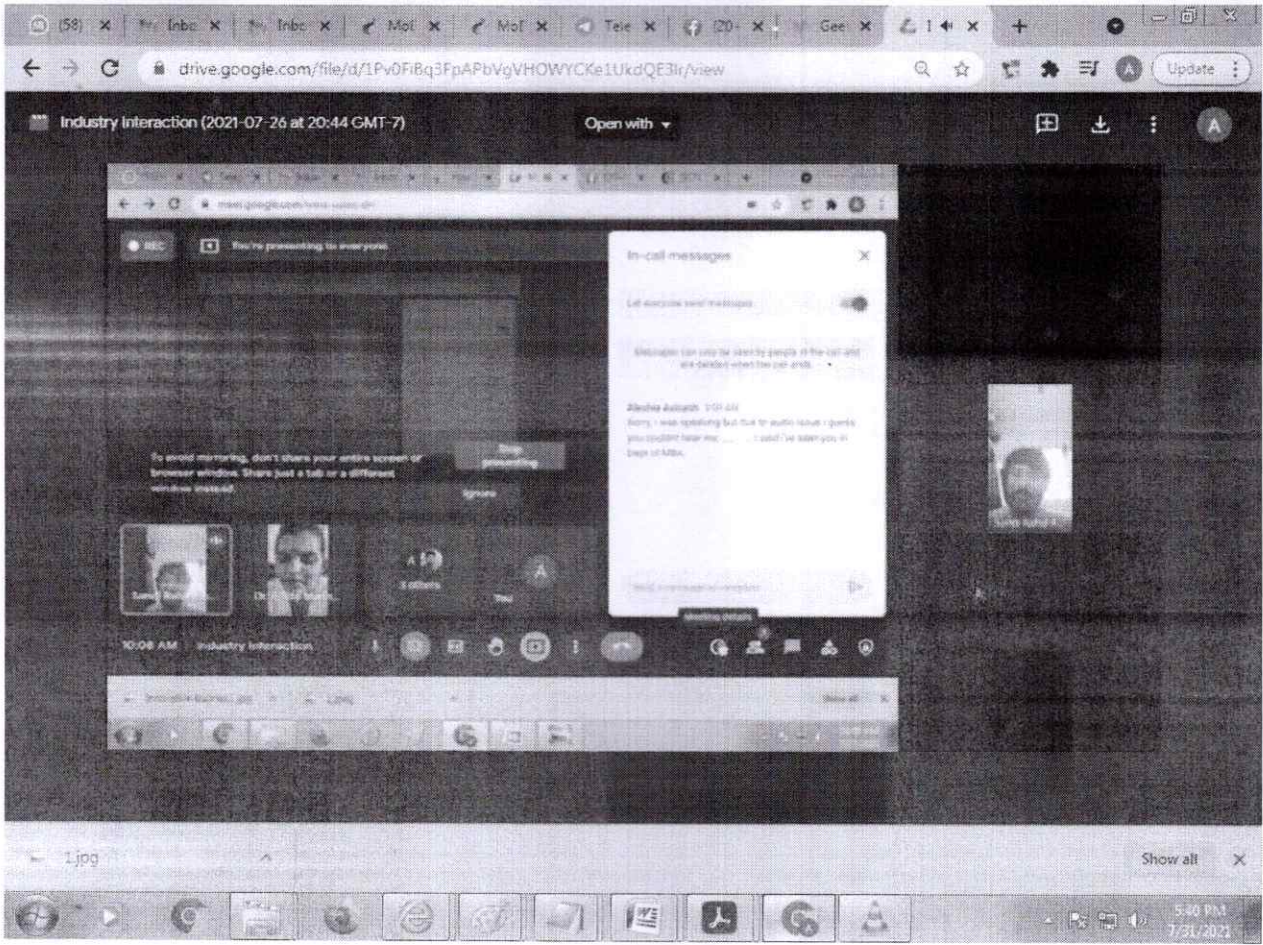

*[Handwritten signature]*

**PRINCIPAL**  
Geethanjali College of Engg. Tech.  
Cheeryal (V), Keasara (M), R.R. Dist. (A.P.) - 501 301

# Application for participation in JVEN SHARKTANK EVENT

Applications are invited for Entrepreneurs in JLABS or Alumni for participation in JVEN Sharktank Event scheduled in August 2021.

The event is being organized by JNTUH Global Alumni Association. The shortlisted applicants will be contacted by the JVEN core team for preparation for the event.

The last date for sending your interest is 24th July 2021

\* Required

Name of the Startup \*

Exodrone Systems Private Limited

Team Size \*

8 Full time + 4 interns

Website \*

<https://www.exosl.com/about>

PRINCIPAL  
Geethanjali College of Engg. Techn.  
Cheeryal (V), Kossuru (M), R.R. Dist. (A.P.) - 501301





# Application for participation in JVEN SHARKTANK EVENT

Applications are invited for Entrepreneurs in JLABS or Alumni for participation in JVEN Sharktank Event scheduled in August 2021.

The event is being organized by JNTUH Global Alumni Association. The shortlisted applicants will be contacted by the JVEN core team for preparation for the event.

The last date for sending your interest is 24th July 2021

\* Required

Name of the Startup \*

Zweirad Electric Private Limited

Team Size \*

5

Website \*

<https://www.zweiradelectric.com/>

PRINCIPAL  
Geethanjali College of Engg. Tech.  
Keesara (M), R.R. Dist. (A.P.) - 501 301

Brief background of the Startup \*

Started as an undergrad student major project. Won prize for unique design features at 'Electric two wheeler design' competition, organised by SAE India. Design is patent pending.



Company Registration Number along with date of incorporation \*

U34300TG2021PTC150123

Funding Plans for the Project \*

To establish strong supply chain and to get the necessary machinery and employ people with adequate skills. A portion of the funds will be used for R&D, so that we keep making the product better. Some of it shall also be used to establish an assembly line.

Name of the SPoC nominating the Startup \*

Dr. Anil Kumar Puppala

Submit

Never submit passwords through Google Forms.

This form was created inside of JNTU Hyderabad. [Report Abuse](#)

Google Forms

PRINCIPAL  
Geethanjali College of Engg. Tech.  
Chaeryal (V), Keesara (M), R.R. Dist. 16.11.2019

Name of the Founder \*

Kotte Yaswanth Reddy

Email id of the Founder \*

yashureddy444@gmail.com

Mobile Number of the Founder \*

8008679059

Name of the Co-Founder

Dr. Radhika Dora, Kotha Yashwanth Reddy

Email id of the Co-Founder

kyashwanthreddy623@gmail.com

Mobile Number of the Co-Founder

8309186088

PRINCIPAL  
Goethanjali College of Engineering & Tech.  
Choeryal (V), Keesara (M), R.R. Dist. (A.P.) - 501 301



# Application for participation in JVEN SHARKTANK EVENT

Applications are invited for Entrepreneurs in JLABS or Alumni for participation in JVEN Sharktank Event scheduled in August 2021.

The event is being organized by JNTUH Global Alumni Association. The shortlisted applicants will be contacted by the JVEN core team for preparation for the event.

The last date for sending your interest is 24th July 2021

\* Required

Name of the Startup \*

Exodrone Systems Private Limited

Team Size \*

8 Full time + 4 interns

Website \*

<https://www.exosl.com/about>

PRINCIPAL  
Geethanjali College of Engg. Tech.  
Cheerla (V), Keeravani (M), R.R. Road, Chevuru - 501 201

Email id of the Co-Founder

Sharath@exosl.com

Mobile Number of the Co-Founder

9030398970

Company Registration Number along with date of incorporation \*

U29200TG2020PTC147118 Date of Registratic

Funding Plans for the Project \*

We are targeting an unexplored area of Indian drone scenario including warehouse drones and Agricultural subscription drone Kits. The agricultural drone kits consists of a Spray drone as well as a Flying wing drone which can be used to study the strength of plants and soil through Multi-spectral payload. In order to achieve Indigenization, they plan to set up their our own workshop which basically demand a variety of machinery as we will be working primarily on composites and additive manufacturing.

Name of the SPoC nominating the Startup \*

Dr. Anil Kumar Puppala, Geethanjali College of

Submit

Never submit passwords through Google Forms.

This form was created inside of JNTU Hyderabad. [Report Abuse](#)

PRINCIPAL  
Geethanjali College of Engg. Techn.  
Chourasani (V), Keesara (M), R.R. Dist. (A.P.)-501301



## Application for participation in JVEN SHARKTANK EVENT

Applications are invited for Entrepreneurs in JLABS or Alumni for participation in JVEN Sharktank Event scheduled in August 2021.

The event is being organized by JNTUH Global Alumni Association. The shortlisted applicants will be contacted by the JVEN core team for preparation for the event.

The last date for sending your interest is 24th July 2021

\* Required

Name of the Startup \*

I step towards Vidya

Team Size \*

1

PRINCIPAL  
Geethanjali College of Engg. Tech.  
Cheerukudi (V), Keesara (M), R.R. Dist. (A.P.) - 501 309.

7/24/2021

Application for participation: in JVEN SHARKTANK EVENT

Mobile Number of the Founder \*

6300500985

Name of the Co-Founder

Your answer

Email id of the Co-Founder

Your answer

Mobile Number of the Co-Founder

Your answer

<https://docs.google.com/forms/d/e/1FAIpQLSdgJScHk1R7KTMctamQx2zh4mBSOz9qXwFe1ID9ywHMXYO9UA/viewform>

  
PRINCIPAL  
Geethanjali College of Engg. Techn.  
Cheeryal (V), Keerasa (M), R.R. Dist. (A.P.) - 501 302



# Application for participation in JVEN SHARKTANK EVENT

Applications are invited for Entrepreneurs in JLABS or Alumni for participation in JVEN Sharktank Event scheduled in August 2021.

The event is being organized by JNTUH Global Alumni Association. The shortlisted applicants will be contacted by the JVEN core team for preparation for the event.

The last date for sending your interest is 24th July 2021

\* Required

Name of the Startup \*

Automotive Wheels Private Limited

Team Size \*

3

Website \*

There is no website yet. But found an investor

Brief background of the Startup \*

Wheel chairs for the disabled are currently being driven manually. Our patent pending 'electric and electronic kit' shall come as an independent unit that can be a fitted to the wheel chair to automate it and give freedom to the disabled.

Geethanjali College of Engineering & Technology  
Keesari, K.R. Dist. (A.P.) - 501 301  
PRINCIPAL

Company Registration Number along with date of incorporation \*

U31904TG2021PTC150207

Funding Plans for the Project \*

Procuring the raw material outsourcing the same for manufacturing. Training personnel for Assembling the kit to the existing wheelchairs

Name of the SPoC nominating the Startup \*

Dr. Anil Kumar Puppala

Submit

Never submit passwords through Google Forms.

This form was created inside of JNTU Hyderabad. [Report Abuse](#)

Google Forms

**PRINCIPAL**  
Geethanjali College of Engg. Tech.  
Cheeryal (V), Keesara (IA), R.R. Dist. (A.P.) - 501 301





# Geethanjali College of Engineering and Technology

CHEERYAL (V), KEESARA (M), Medchal DIST-501301, Telangana

## Report on

### Orientation session by Innovation Ambassadors of GCET

27<sup>th</sup> Aug 2021

During all the programs that GCET IIC has conducted, It was realized that the attendance for the different sessions from students is still low.

#### Objective:

To orient the students and faculty of the college about the Innovation cell in the college by the innovation ambassadors.

#### Expected Outcome:

The students and faculty are encouraged to express their innovative ideas through the design thinking principles. They are expected to work in coordination the innovation cell of the college

#### Session Plan:

- Introduce the innovation cell of GCET
- Scope in orientation with the National Educational Policy
- Introduce design thinking
- Orient the students with the activities conducted under the purview of the innovation cell

Name of the Dept	No. of students attended	Number of Faculty attended	Link of video Session
Dept of CSE and allied	44	8	<a href="https://drive.google.com/file/d/18jITv4oG-TvwtcF_yR6MIBMywWS_ztGh/view?usp=sharing">https://drive.google.com/file/d/18jITv4oG-TvwtcF_yR6MIBMywWS_ztGh/view?usp=sharing</a>

  
PRINCIPAL  
Geethanjali College of Engg. Tech.  
Cheeryal (V), Keesara (M), R.R. Dist. (A.P.) - 501 301

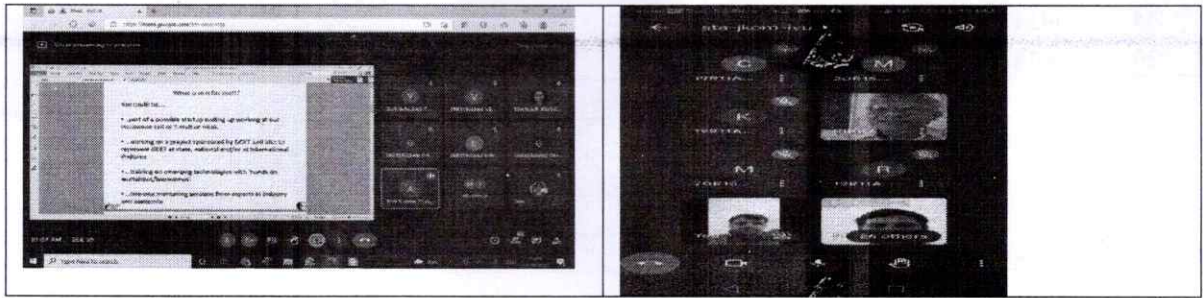

Attendance from individual departments:

S. No	Roll No.	Names of Participants
1	SC1384	Dr.S.Spandana
2	SC1428	Dr.S.Vallisree
3		OVPR Sivakumar
4	19R11A0408	CHILLA KRISHNA BHASKARA SATYA SRIVATHSA
5	19R11A0410	DACHA SURYA AMSHU
6	19R11A0412	GANGAVARAPU MADHU
7	19R11A0417	KAVADI SALMANRAJU
8	19R11A0423	MADIREDDY BHARGAV REDDY
9	19R11A0425	MOSALI JYOTHI
10	19R11A0433	PEDDABOINA VAISHNAVI
11	19R11A0434	PERAM BHAVYA SAI
12	19R11A0436	POTHU SAI TEJA
13	19R11A0441	SHERIPALLY ROHITH
14	19R11A0448	YARRABOINA VENKATA SRAVYA
15	19R11A0497	ARISA RAJESHWARI AMMAJI PRATHYUSHA
16	19R11A0499	AVULA SUPREETH
17	19R11A04A0	BARRE HARSHINI
18	19R11A04A5	CHENNAGALLA ARCHANA ROY
19	19R11A04A9	G SHREE CHANDANA
20	19R11A04C0	KUJA UDAY SRI
21	19R11A04C3	MAHADEVAPURAM SATHWIK SAI
22	19R11A04C9	NEELA MEGHANA GOVARDHANAM
23	19R11A04D1	PARITALA SHASHIVIGNESH
24	19R11A04D2	POTHAMSHETTY SUMAN
25	19R11A04D6	S DEERAJ
26	19R11A04D8	SHRUTI SINGH
27	19R11A04E0	TEEGALA HARSHA SAI TARANG
28	19R11A04E2	VADLOORI JAYA SRI
29	19R11A04E4	YENIMIREDDY SANDHYA
30	19R11A04F0	CHEERLA AKSHITHA
31	19R11A04F1	CHENNA SURYA VAMSHI
32	19R11A04G2	HARSHA VARDHAN SAI KARNA
33	19R11A04G3	INTURI ASHRITHA

  
 PRINCIPAL  
 Geethanjali College of Engg. Tech.  
 Chervu (V. Basavara (M), R.R. Dist. (A.P.)-501104



19R11A05F8 DODLE VENKATESH	present	100
19R11A05F9 G MAITHREYI	present	100
19R11A05G0 G VENNEL YADAV	present	100
19R11A05G2 GAZULA SHEBA RANI	present	100
19R11A05G6 GUNDETI SANNIHITHA	present	100
19R11A05G7 HEMANTH NELLURI	present	100
19R11A05G8 JAYYARAPU SAI VAMSHI	present	100
19R11A05H0 KALAVAKOLANU SUDARSHAN SHARMA	present	100
19R11A05H1 KANAMARLAPUDI REVANTH	present	100
19R11A05H3 KANITHI HEMANTH	present	100
19R11A05H6 KOMMU NIHARIKA	present	100
19R11A05H8 MALLARAPPU MAHESHWARI	present	100
19R11A05H9 MUKKU DEERAJ REDDY	present	100
19R11A05J1 P SHIVANI	present	100
19R11A05J3 PULIPAKA SAI ABHIGNU	present	100
19R11A05J5 RACHAPUDI JAYANI	present	100
19R11A05J6 RAKESH KUMAR BOMSETTY	present	100
19R11A05J7 S ASHVITHA	present	100
19R11A05J8 SARABUDLA VIKRAM REDDY	present	100
19R11A05J9 SHANKRAPOLLA SOWMYA REDDY	present	100
19R11A05K0 VEESAMSHETTY VARUN	present	100
19R11A05K1 VISWANADHAPALLI MYTHILI	present	100
19R11A1232 NALLAVELLI SRIMAN	present	100
20R15A0114 Miss SHAIK AFREEN	present	100
20R15A0518 Mr. JAVVAJI SHOBHAN BABU	present	100
20R15A0519 Mr. KONDA KRISHNASAI	present	100
20R15A0521 METTU MADHURI	present	100
M SHIVA PRASAD GCET	present	100
P HARITHA GCET	present	100

Time: 2021-8-25\_14:14:25

VOLETI.PADMAJA GCET(You)keep\_off

18R11A0266 C.H.SAI KARTHIK

19R11A0206 BANALA SAI SANJAY

19R11A0207 BARU TARUN KAUSTHUB

19R11A0211 C S SHASHANK

19R11A0213 DANDA SRAVANI JYOTHI

19R11A0217 GUJJARLAMUDI SUMEDHA

19R11A0220 KANUPARTHI SRI VENKATA NAGA SINDHUJA

19R11A0233 PANTULA UDITH NAGA RATNAKAR

19R11A0244 B ALANKRITH GOUD

19R11A0245 BANOTH AMEENA

19R11A0247 CHENNOJU ANUDEEP

19R11A0249 GATTIGORLA SUDHA

19R11A0252 GUGULOTHU VIJAY

19R11A0254 JUPALLY SAI KUMAR

PRINCIPAL  
Geethanjali College of Engg. Techn.  
(Cheerly (V), Keeravani (H), R.R. Dist. (A.P.) - 501 301)

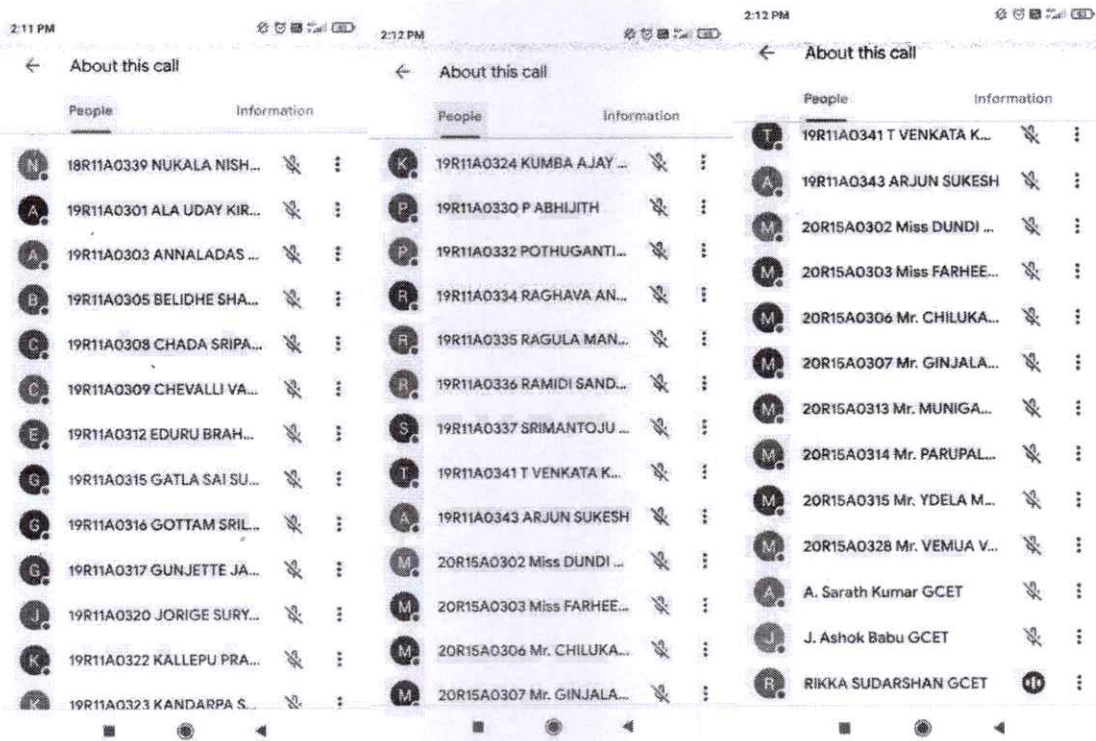

Poster/banner:



**Geethanjali College of Engineering and Technology**  
 (UGC Autonomous Institution Accredited by NBA & NAAC,  
 Permanently Affiliated to JNTUH, ISO 9001:2015 certified)  
 Cheeryal (V), Keesara (M), Medchal. Dist. 501301



**Orientation session**  
 by  
**Innovation Ambassadors at**  
**Geethanjali College of Engineering and Technology**  
**27<sup>th</sup> Aug 2021.**

PRINCIPAL  
 Geethanjali College of Engg. Tech.  
 S.R. Dist. (A.P) - 501301

Department	Time	Joining Link
CSE and Allied Branches	9:00 AM	<a href="https://meet.google.com/vpf-teca-qje">https://meet.google.com/vpf-teca-qje</a>
ECE	1:30 PM	<a href="https://meet.google.com/kzh-oavj-zgs">https://meet.google.com/kzh-oavj-zgs</a>
EEE	10:00 AM	<a href="https://meet.google.com/ktt-snvd-rdp">https://meet.google.com/ktt-snvd-rdp</a>
ME	1:30 PM	<a href="https://meet.google.com/sta-jkom-ivu">https://meet.google.com/sta-jkom-ivu</a>
CE	10:00 AM	<a href="https://meet.google.com/ktt-snvd-rdp">https://meet.google.com/ktt-snvd-rdp</a>



**Geethanjali College of Engineering and Technology**  
**UGC Autonomous**  
**Cheeryal(V), Keesara(M)**  
**Medchal District, Hyderabad**  
**Telangana State**  
**Report on Project Exhibition**  
**Conducted on 24-07-2021**

By

**Department of Freshman Engineering and Centre for Soft Skills Development**

A Three Day Workshop on Design Thinking and Critical Thinking was organized for I.B.Tech, I sem students from 28<sup>th</sup> February to 2<sup>nd</sup> March, 2021. From then, students continued to consolidate the project work under the continuous monitoring and supervision by the undersigned. The necessary support from the college was provided till the completion of the projects. Then, an exhibition was conducted on 24-07-2021 to encourage the students.

Mr.Y.V.N.Phani Kishore, Team Lead ACCELQ Software Solutions judged the projects and has given right direction for the students.

**Teams and Project titles**

S.No	Team No.	Name of the student	Roll No	Branch and Section	Project Title	Remarks
1	1	VA Tanmai	20R11A6759	CSE-DS	Automation Parking System	Working Model
2		P.Srikanth	20R11A0232	EEE	Automation Parking System	
3		MD.Waseem	20R11A1242	IT		
4		Sanka Gayathri	20R11A04A4	ECE-B		
5	2	Sanjeev.S	20R11A0148	CE	Automatic Drip Irrigation System using Solar Cell	Working Model
6		R.Saunak Jain	20R11A0444	ECE-B		
7	3	Hari Sarada	20R11A05K9	CSE-D	Self-reporting robotic arm-Arduino based	Working Model
8		Sathwik Parasa	20R11A6943	CSE-IoT		
9		Ashrith Gadeela	20R11A05J4	CSE-D		
10	4	K.Anusha	20R11A05E6	CSE-C	Growpal-supplying trees according to the customers' needs	Website
11		M.Karthik	20R11A04M0	ECE-D		
12		K.Sai Karthik	20R11A0147	CE		
13		T.Venkata Sai Anirudh	20R11A04B9	ECE-B		
14	5	Vempati Bhanu Vamshi	20R11A6259	CSE-CS	Reducing the queue time at billing counter	APP

  
**PRINCIPAL**  
 Geethanjali College of Engg. Tech.  
 Cheeryal (V), Keesara (M), Medchal District, Hyderabad - 501 301

				AI&ML		
44		Sufia	20R11A05H0	CSE-C		
45		Ashish	20R11A04G8	ECE-C		
46	14	B.Yamini Sri Bhavya	20R11A0468	ECE-B	Waste Crushing Dustbin	Demo Model
47	15	Sharan Naaroju	20R11A0496	ECE-B	Face tracker using open CV and arduino	Demo Model
48		Sai Teja	20R11A6624	CSE-AI&ML		

Coordinator(s)  
Dr.B.Nagamani  
Associate Professor of English

Ms.V.Manjula  
Asst.Professor of Physics

Encl(s): Photographs

  
**PRINCIPAL**  
Geethanjali College of Engg. Tech.  
Georjal (V), Keesara (M), Dist. East (A.P) - 501 301



**Design Thinking Project Presentation**

24-07-2021

Name of the student	Roll Number	Branch	Section	Team No.	Title of the Project	Sign
<b>Team 1</b>						
VA Tanmai	BOR11A6189	CSE-DS		1	Automation Parking System	VA Tanmai
P. SriRanjith	BOR11A6083	FEE		1		P. SriRanjith
MD. Wassem	BOR11A1043	IT	A	1		MD. Wassem
Sanka Gayathri	BOR11A0604	ECE	B	1		Sanka Gayathri
<b>Team 2</b>						
SANJEEV S	BOR11A0108	CE	A	2	Automatic Drip Irrigation system using Arduino	SANJEEV S
Raj Kumar Jain	BOR11A0104	ECE	A	2		Raj Kumar Jain
<b>Team 3</b>						
Hari Savada	BOR11A0519	CSE-D	D	3	IoT based automatic water irrigation system	Hari Savada
Suzhik Parvathi	BOR11A0520	CSE-IOT	IOT	3		Suzhik Parvathi
Achuth Gudana	BOR11A0514	CSE-D	D	3		Achuth Gudana

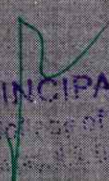
  
**PRINCIPAL**  
 Geethanjali College of Engg. Techn.  
 Bangalore, Karnataka - 560075



Name of the student	Roll Number	Branch	Section	Team No.	Title of the Project	Sign
<b>Team 7</b>						
H. Sai Kalyana Koushik	20R11A0515	CSE	C	7	An E-commerce initiative for farmers	[Signature]
Joshua Daniel P	20R11A0513	CSE	C	7		[Signature]
<b>Team 8</b>						
F. Sai Aditya	20R11A0514	CSE (IoT)		8	Text Bot	[Signature]
Ganesh Lokesh	20R11A0514	ECE	D	8		[Signature]
M. Riddhi Anurag	20R11A0514	CSE	D	8		[Signature]
V. Bhoomika	20R11A0514	ECE	B	8		[Signature]
<b>Team 9</b>						
P. Hima	20R11A0515	ECE-D	D	9	Multi purpose Device	[Signature]
A. Kiranthama	20R11A0517	CSE-C	C	9	Multi purpose Device (MPD)	[Signature]
S. Manu Prasad	20R11A0518	ECE-B	B	9	MPD	[Signature]
M. Yashpal Reddy	20R11A0532	Mech	A	9	MPD	[Signature]
T. Vignesh						

  
**PRINCIPAL**  
 Geethanjali College of Engineering & Technology  
 Chittoor (A.P.)

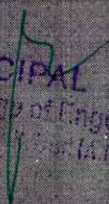

Name of the student	Roll Number	Branch	Section	Team No.	Title of the Project	Sign
<b>Team 13</b>						
M. Shatananda Shama	20011A0491	ECE	B	13	vertical axis wind turbine	
G. HARSHITHA	20011A6617	CSE - AIML	B	13	vertical axis wind turbine	
Sufia	20011A0580	ECE	C	13	vertical axis wind turbine	
Ashish	20011A0468	ECE	C	13		
<b>Team 14</b>						
BEJJA Yashini Sri Shaya	20011A0469	ECE	B	14	Waste crushing Machine	
<b>Team 15</b>						
Shavan Nataraj W.	20011A0498	ECE	B	15	Face tracker using Open CV and Arduino	
<b>Team 15</b>						
Sat teja	20011A6624	CSC	ADML	15		

  
**PRINCIPAL**  
 Geethanjali College of Engg. Tech.  
 G. S. Road, Puttur (A.P.) - 501 201





# Geethanjali College of Engineering and Technology

CHEERYAL (V), KEESARA (M), Medchal DIST-501301, Telangana

Report on

## Workshop on Prototyping Followed by Virtual tour of Technology Business Incubation Center

Date: 7<sup>th</sup> July 2021

**Need Analysis:** An orientation for the newly inducted first year session is needed for hands on experience on prototyping and a general overview of the Incubation Center.

**Objective:** Students of the second year and third year engineering students needed to have hands on experience on prototyping with a view to complete the projects in time. Hence this session was organized

**Resource Person:** Mr. Amit Sharma, Project Manager, Technology Business Incubator, KIET Ghaiziabad

**Students Benefitted:** 140

**Faculty:** 37

**Total:** 177

**Link to the Recorded session of the Video:**

<https://drive.google.com/file/d/1HdreXRnI0-WaLbIR95g1rnur2Js7il13/view>

Geethanjali College of Engg. Tech.  
(Cheeryal (V), Keesara (M), R.R. Dist. (A.P.) - 501301)



The image shows a screenshot of a presentation slide. At the top, there is a browser toolbar with icons for back, forward, search, and zoom, along with a page indicator '1 / 1' and a zoom level of '66.2%'. The slide content includes:

- Logos:** 'INSTITUTION'S INNOVATION COUNCIL (Ministry of HOD Institutes)' on the left, a stylized 'K' logo in a circle in the center, and 'KIET GROUP OF INSTITUTIONS Affiliated to Dr. A.P.J. Abdul Kalam Technical University, Lucknow' on the right.
- College Name:** 'Geethanjali College of Engineering and Technology' in a large, stylized font.
- Accreditation:** 'UGC Autonomous' and 'Approved by AICTE, Permanently Affiliated to JNTUH'.
- Organizer:** 'Organized by Institution's Innovation Council, GCET'.
- Event Title:** 'Virtual Field/ Exposure Visit to Incubation Unit'.
- Location:** 'at KIET, Ghaziabad'.
- Date and Time:** 'On 07<sup>th</sup> Jul, 2021 from 11:00 AM'.

The background of the slide features a hand pointing at a glowing brain with circuit-like patterns, symbolizing technology and innovation.

Circular:

  
PRINCIPAL  
Geethanjali College of Engg. Tech.  
Chhaprol (V), Keerasa (M), R.R. Dist. (A.P.) - 501 306.

drive.google.com/file/d/1HdreXRnI0-WaLbIR95g1mur2ls7iI13/view

Online Workshop on Prototyping by IIC, GCET (2021-07-06 at 22:34 GMT-7)

**Prototype**

**Build to think. A simple, cheap and fast way to shape ideas so you can experience and interact with them.**

- **Start building:** Create an artefact in low resolution. This can be a physical object or a digital clickable sketch. Do it quick and dirty.
- **Storyboard:** create a scenario you can role play in a physical environment and let people experience your solution

pb

IIC Report 10jul2...docx | IIC ATTENDANCE...xlsx | E-week (2).zip | Show all

12:47 PM 7/31/2021

PRINCIPAL  
Gobindrajali College of Engg. Tech.  
(Autonomous), Karamuru (Dist. N.P. Dist. (A.P.) - 501 307



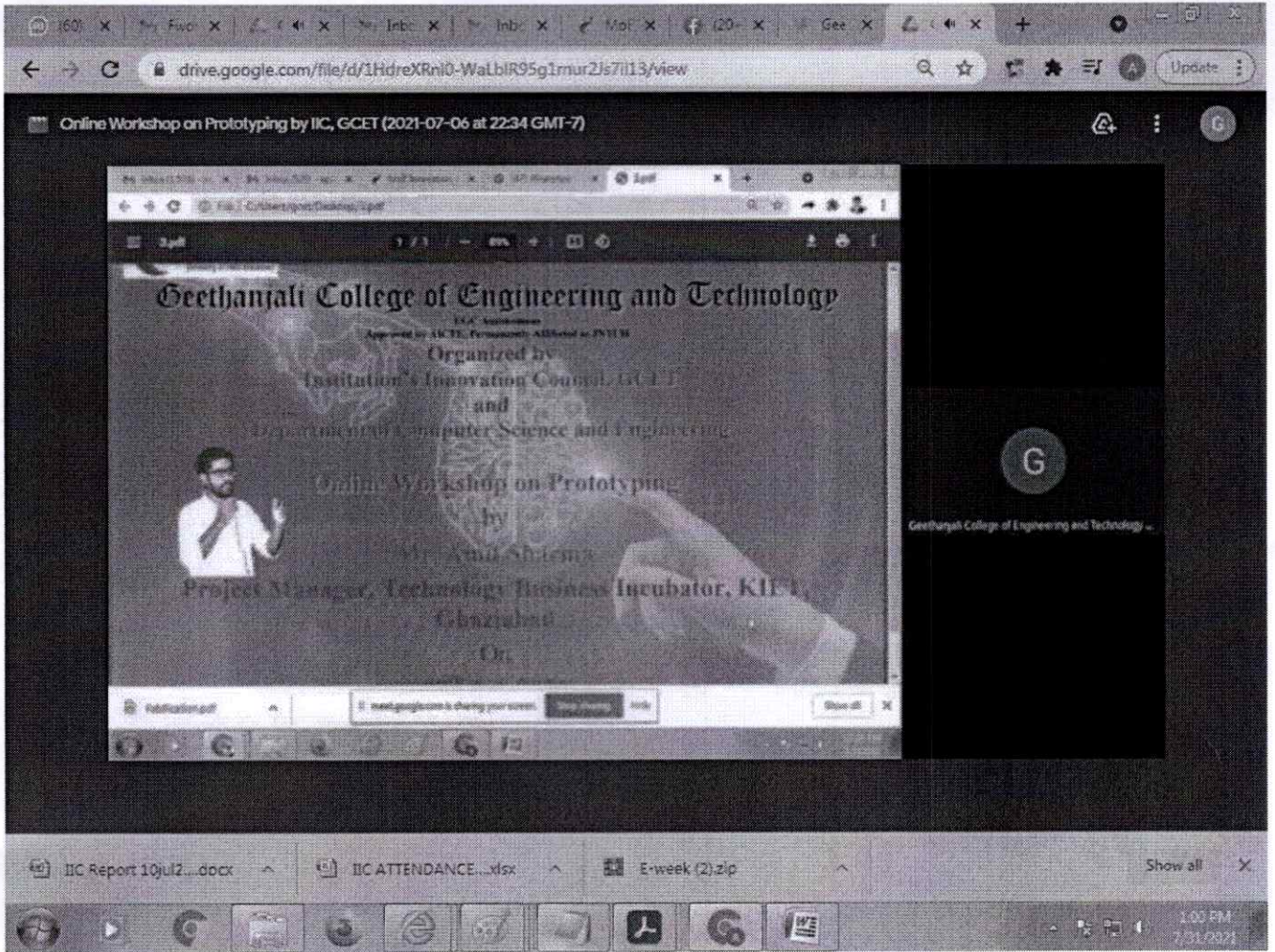

Letter of Appreciation:

  
PRINCIPAL  
Geethanjali College of Engg. Tech.  
Cheerel 201, Keasare (201), R. Dist. (A.P.) - 501 301



**Attendance:**

There was no attendance taken for this particular session. **However, video recording (snapshot at time 1:11:47 of the video (which may be verified from the video), shows that there are 177 total participants** who got benefitted with these two combined sessions. Hence it may please be considered for evaluation.

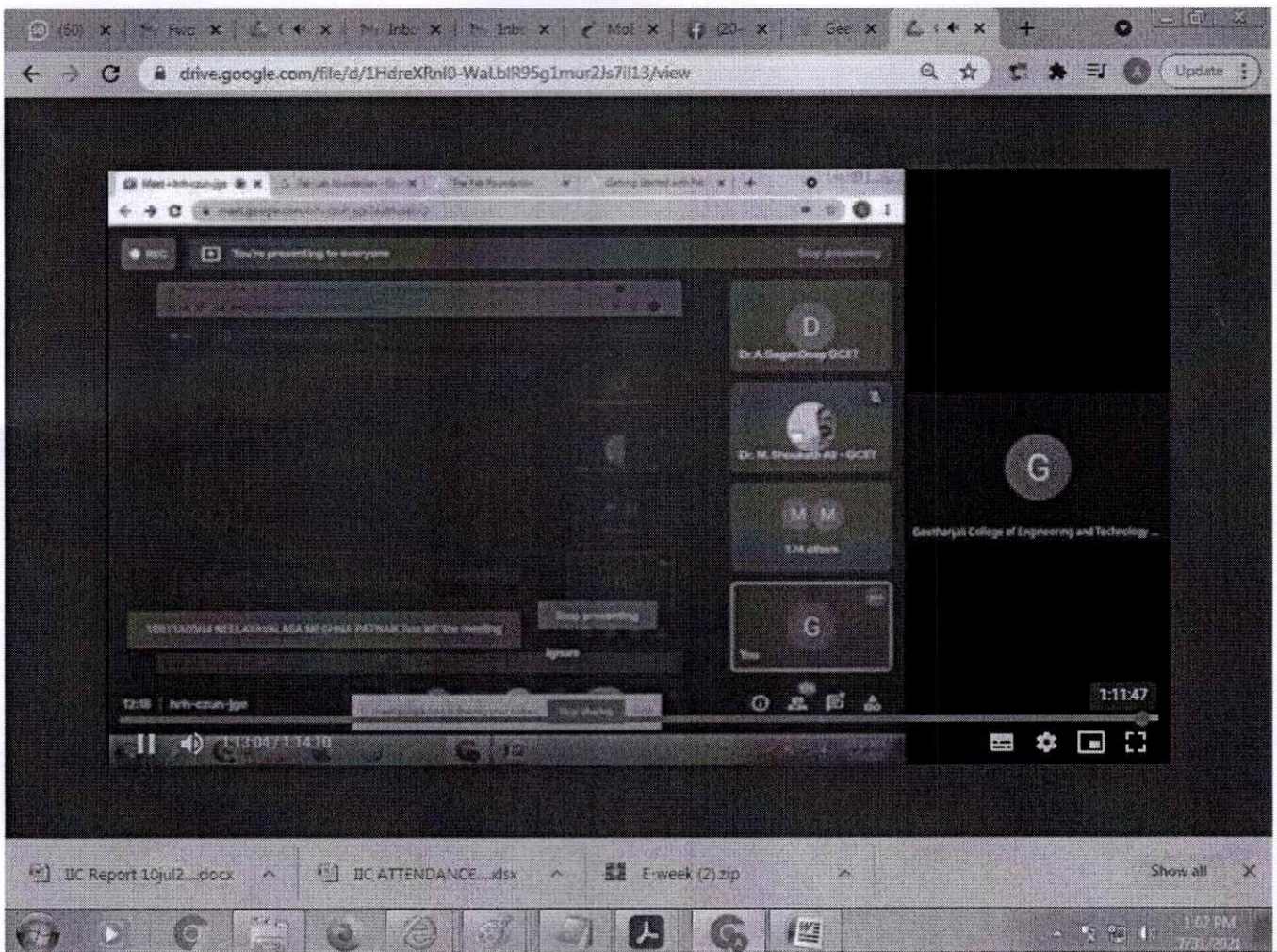

*(Handwritten signature in green ink)*  
**PRINCIPAL**  
Geethanjali College of Engg. Tech.  
Cheerajol (V), Kessuru (H), R.R. Dist. (A.P.) - 501 301





## **Geethanjali College of Engineering and Technology**

CHEERYAL (V), KEESARA (M), Medchal DIST-501301, Telangana

Report of the activities conducted...

*As a part of awareness drive about Startup and related Ecosystem*

*Opportunities for Students & Faculties and Early Stage Entrepreneurs at*

*AIC - IIITHyderabad*

Team from 'Atal Incubation Center (AIC)-IIIT Hyderabad

(Online)

*Dated: Time: 17<sup>th</sup> July 2021 11:00 AM – 12:00 PM*

*And*

*iSETiLAB*

Incubator Foundation, Karnataka Bengaluru

(Online)

Dated: 30th July 2021 at 2pm to 3pm

  
**PRINCIPAL**  
Geethanjali College of Engg. Tech.  
Cheeryal (V), Keesara (M), R.R. Dist. (A.P.) - 501 301.

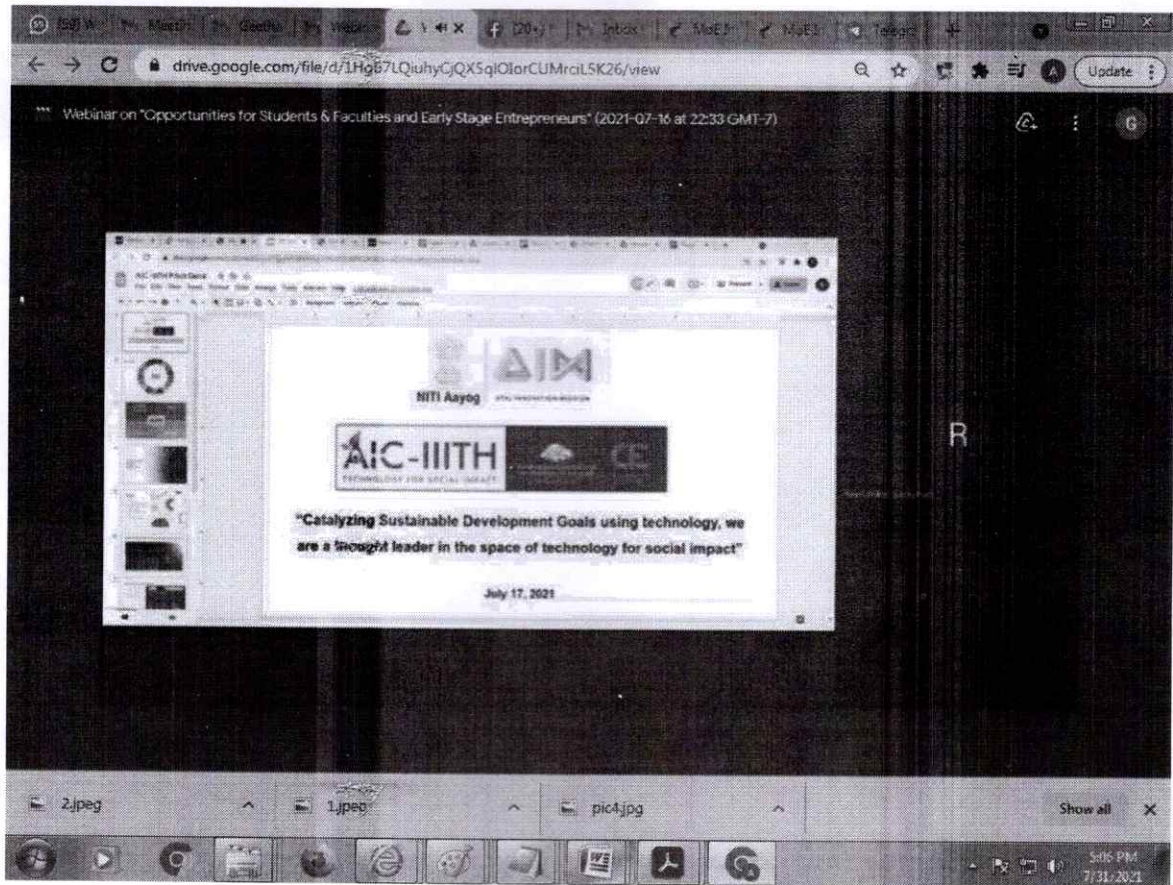

PRINCIPAL  
Geethanjali College of Engg. Tech.  
Cheeryal (V), Keesara (M), K.R. Dist. (A.P.) - 501 302



**Pictures/Gallery:**

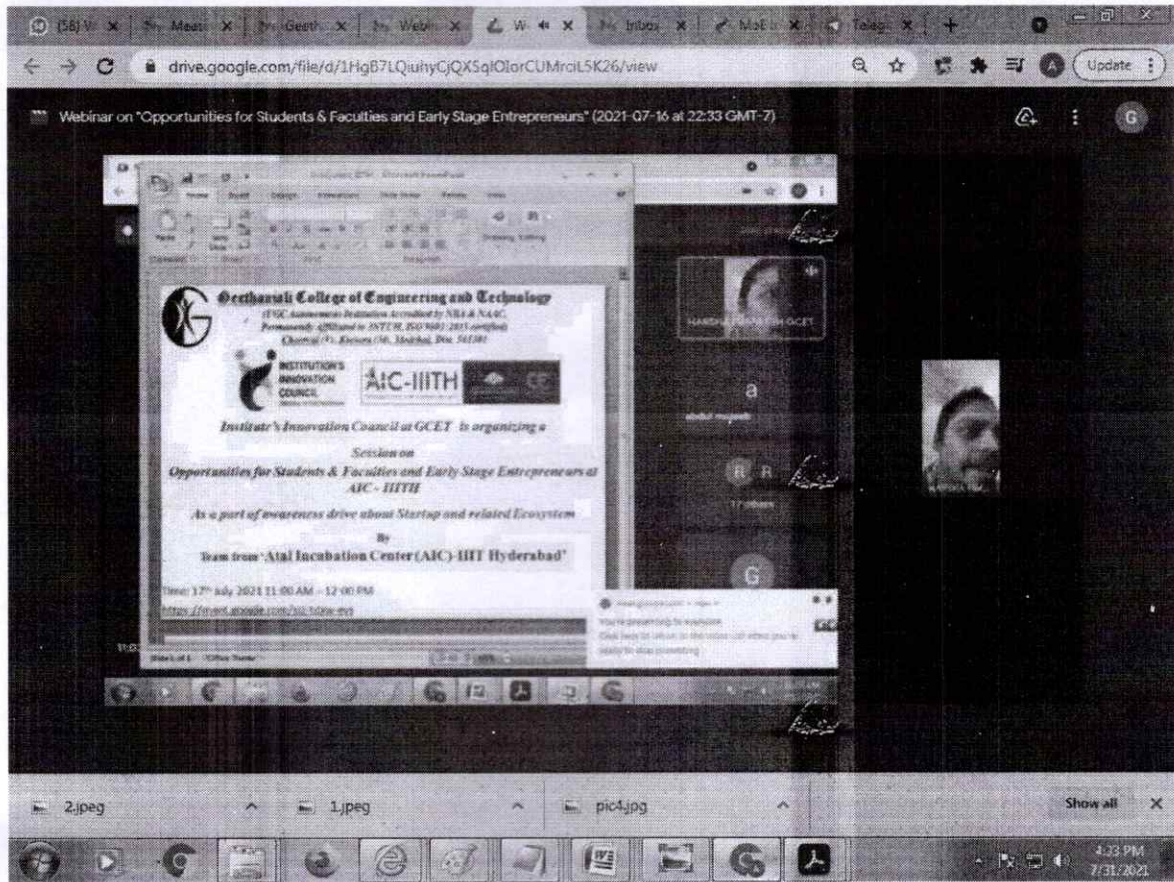

PRINCIPAL  
Geethanjali College of Engg. Tech.  
(Chartered (V), Keesara (M), A.P. Dist. (A.P.) - 501301

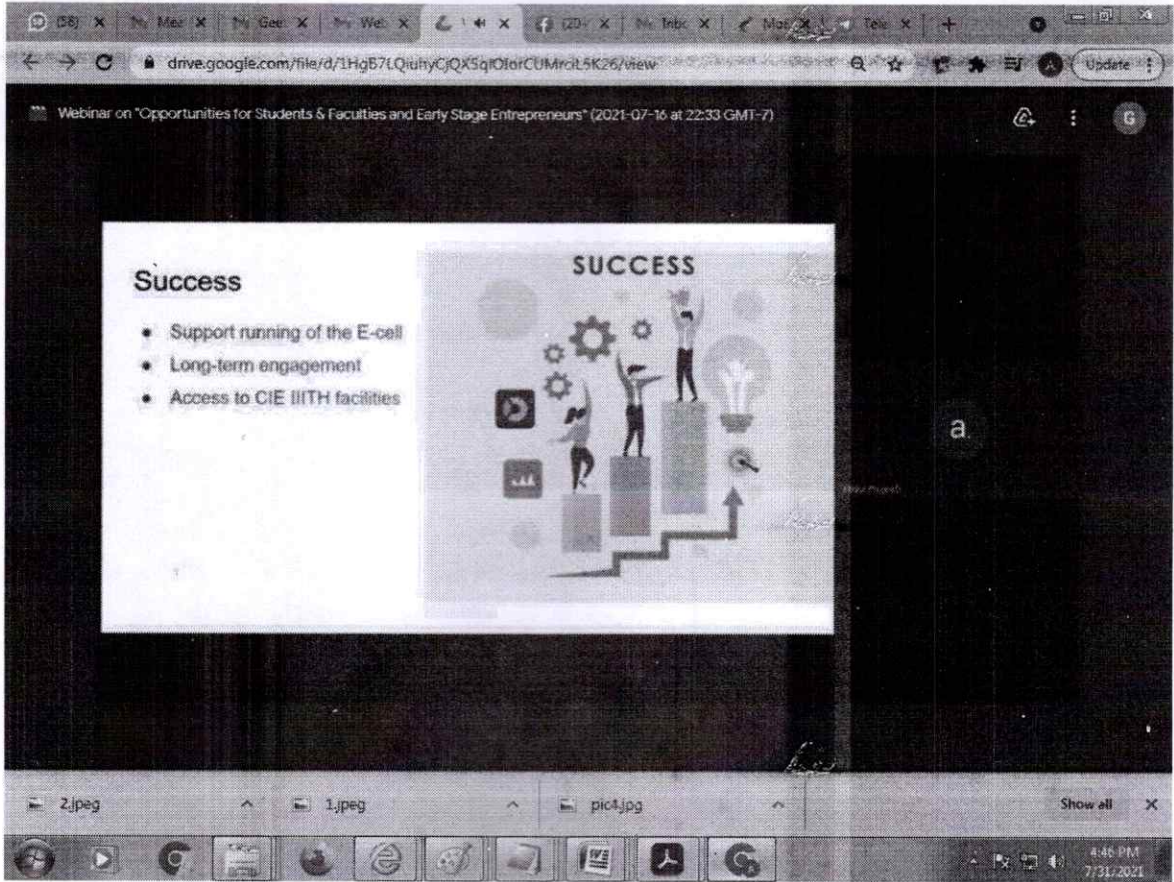

  
PRINCIPAL  
Geethanjali College of Engg. Tech.  
Charyal (V), Nandam (M), R.R. Dist. (A.P.) - 501 361



## Photos of the second session

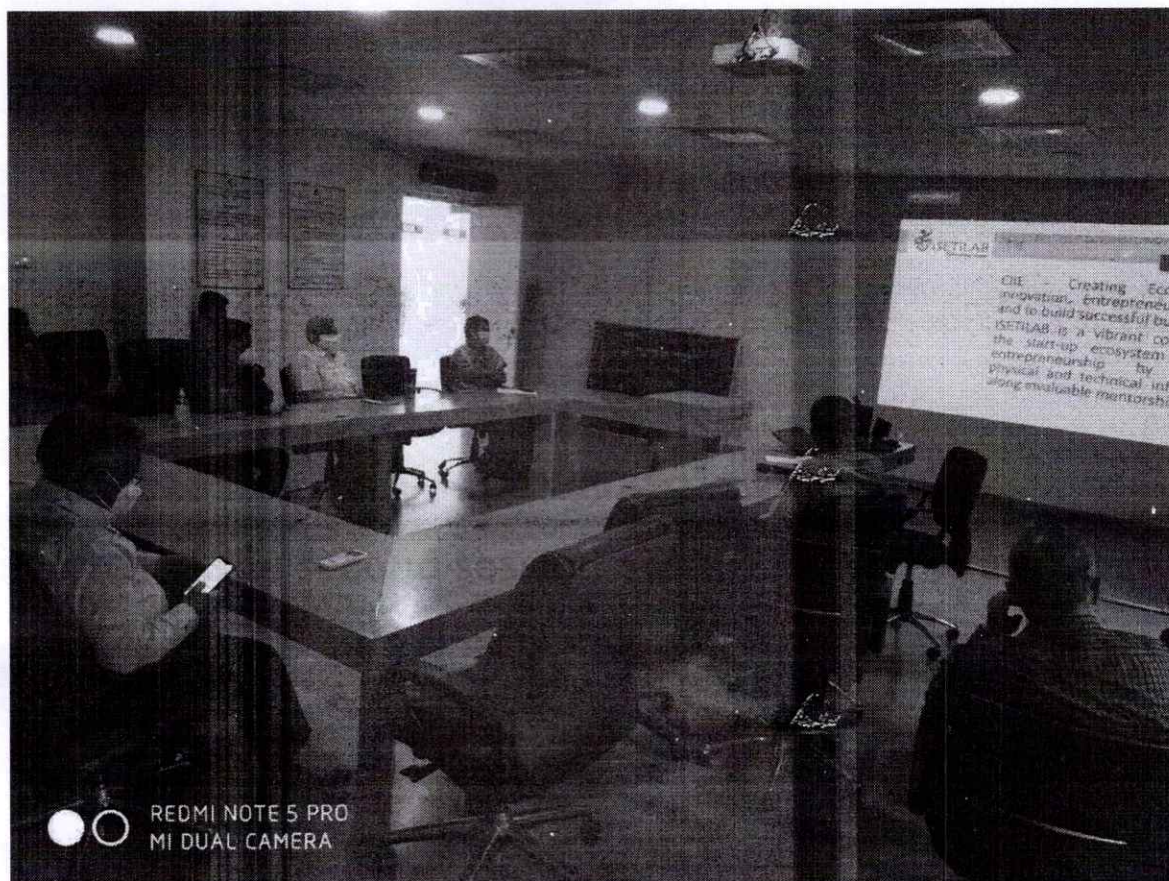

**PRINCIPAL**  
Geethanjali College of Engg. Tech.  
Chennai (V), Keesari (M), E.R. Dist. (K.K.) - 501 304.

# Webinar on "Opportunities for Students & Faculties and Early Stage Entrepreneurs" (2021-0...

REC You're presenting to everyone

To avoid mirroring, don't share your entire screen or browser window. Share just a tab or a different window instead.

Stop presenting

Ignore

Alakhya G has left the meeting

DEVULAPALLI V... M RAJA KRISHN... 47 others You

11:55 Webinar on "Opportunities for St...

52:34 / 53:32

People

- Add people
- C. ESTHER VARMA GCET
- Chandu Reddy
- D. Vamsan Ravi Prasad GCET
- DEVULAPALLI VARUN KUL.
- Dr. M. Shanthi GCET
- Dr. A. Gagan Deep GCET
- Dr. B. NAGAMANI GCET
- Dr. S. SPANDANA GCET

PRINCIPAL  
Geethanjali College of Engg. Tech.  
Chennai (V), Keesara (M), R.R. Dist. (A.P.) - 501 304





# Geethanjali College of Engineering and Technology

CHEERYAL (V), KEESARA (M), Medchal DIST-501301, Telangana

Report on

## Workshop on "Business Model Canvas"

Date: 10<sup>th</sup> July 2021 6:30PM to 7:45 PM

**Objective:** The three Startup companies established at the incubation center and registered at the Trade and commerce ministry had questions on their business models. The objective of the session was to help the three startups write proper business models. Other students interested in entrepreneurship also got benefitted.

**Students Benefitted: 29**

**Faculty: 7**

**Total: 36**

**Banner:**

facebook.com/geethanjaliinstitutions/photos/a.1563232947145805/2264325238793366/

Geethanjali College of Engineering and Technology

Online session on Business Model Canvas !!

Follow us: Geethanjali College of Engineering and Technology  
Code - GCET  
For more details visit us:  
<http://www.geethanjalinstitutions.com/>  
Help Line : +91-9866308271, 9182058187

#onlinesession #BusinessModelCanvas  
#BestEngineeringCollege  
#bestcollegeinHyderabad  
#bestcollegeinTelangana  
#TopEngineeringCollege  
#GeethanjaliCollegeofEngineeringandTechnology #GCET #GCET #GeethanjaliInstitutions #Hyderabad

Like Comment Share

Write a comment...

PRINCIPAL  
Geethanjali College of Engg. Tech  
(M), R.R. Dist. (A.P.)-501 301



Google Account | IIC ATTENDANCE or ONLINE W... | Meet - wom-igfh-rgc

https://meet.google.com/wom-igfh-rgc

REC | Manveen Chadha is presenting

## Back of the Envelope Calculations

- ▶ What are Capital Costs ?
- ▶ What are Fixed Costs
- ▶ What are Variable Costs
- ▶ What is Break Even
- ▶ How do you fund the capital costs ?

7:30 PM | wom-igfh-rgc

Type here to search

30°C Hum... 19:30 10-07-2021

drive.google.com/file/d/1L1eqGfH4TYrov20bsuRb6UM0HJ4v5EZ/view

The Lean Canvas as a tool to capture value

PROBLEM	SOLUTION	UNIQUE VALUE PROPOSITION	CHANNELS	CUSTOMER SEGMENTS
	REVIEWS		CHANNELS	
GET TRAFFIC		MONITOR		

Lean Canvas

45:37 / 1:01:36

IIC Report 10jul2...docx | IIC ATTENDANCE...xlsx | E-week (2).zip

11:19 AM 7/31/2021

PRINCIPAL  
 Geethanjali College of Engg. Tech.  
 Cheeryal (V), Keesara (M), R.R. Dist. (A.P.) - 501 302



**IIC ATTENDANCE of ONLINE WEBINAR ON 10/07/2021 (Responses)**

Timestamp	HALL TICKET NUMBER	NAME OF THE STUDENT
7/10/2021 19:08:49	1505	DASU VAMAN RAVI PRASAD
7/10/2021 19:09:40	19R11A05L4	D.Rajya Lakshmi
7/10/2021 19:11:22	17R11A0316	J. Maneesh Kumar Reddy
7/10/2021 19:12:21	SC1093 Faculty	OVPR SivaKumar
7/10/2021 19:12:42	19r11a0329	Oregunta Sai Varun
7/10/2021 19:13:09	SC1390	M Raja Krishna Kumar
7/10/2021 19:16:05	17R11A0316	J. Maneesh Kumar Reddy
7/10/2021 19:20:35	17R11A0339	Sandi. Rahul Reddy
7/10/2021 19:21:53	19r11a0535	Sambari Manikanta
7/10/2021 19:22:33	Sc1388	A. Raghu rama chandra
7/10/2021 19:28:12	19R11A0240	Uber Qadir Dar
7/10/2021 19:28:24	18R11A05B7	K Ashok Gajapathi Raju
7/10/2021 19:28:28	19R11A05J4	Puvvada Abhinaya
7/10/2021 19:28:39	19R11A0590	SAMMETA ASHOK KUMAR
7/10/2021 19:28:48	19R11A05K6	B.Sreenidhi Reddy
7/10/2021 19:29:27	19R11A0590	SAMMETA ASHOK KUMAR
7/10/2021 19:29:35	19R11A05N1	Pooja
7/10/2021 19:29:55	19R11A05J5	Rachapudi Jayani
7/10/2021 19:29:58	19R11A05N1	Pooja
7/10/2021 19:31:02	19R11A05K4	A preethi pavani
7/10/2021 19:32:23	19R11A05M9	Karthik
7/10/2021 19:32:43	19R11A0582	Sai Krishna
7/10/2021 19:34:58	19R11A05K9	Botta swathi
7/10/2021 19:37:40	19R11A05N1	Pooja
7/10/2021 19:39:23	19R11A0486	PUPPALA HEMANTH
7/10/2021 19:44:55	SC1497	G V Vigneshwara Swamy, Asst. Professor
7/10/2021 19:45:55	SC1337	Dr. Anil Kumar Puppala
7/10/2021 19:46:35	19R11A05L5	G NANDINI LAXMI PRIYA
7/10/2021 19:48:09	20R15A0508	Vellanki Mounika
7/10/2021 19:49:07	20R15A0508	Vellanki Mounika
7/10/2021 19:51:37	19R11A05L4	D.Rajya Lakshmi

Principal  
Geethanjali College of Engg. Tech.  
Cheeruvu (V), Keerthi (M), R.R. Dist. (A.P.) - 501 301

# Geethanjali College of Engineering and Technology

(UGC Autonomous Institution Accredited by NBA & NAAC,  
Permanently Affiliated to JNTUH, ISO 9001:2015 certified)  
Cheeryal (V), Keesara (M), Medchal. Dist. 501301



**Institute ID: IC201810433**

**Annual Report 2020-21**

## A. About IIC Institute

- Vision / Mission of IIC established at the Institute

The goal of establishing IIC at the college is to create an atmosphere for students and faculty to produce, grow and commercialize the ideas of creative students through appropriate training, mentoring and technology. Forming a multi-sector, diverse team that can use a wide variety of instruments and methodologies such as design thinking, solution for concept management, open innovation, crowd sourcing and human centric design to help the community ideate, guide discussions, prototypes and solutions and create employment creators

- Journey of IIC established at the Institute

<p>Established IIC at the college in the year 2018-19</p> <p>– Not ranking in NIRF, ARIIA in 18-19</p>	
<p>Conducted 36 Hr Hackathon for the first time following IIC calendar of activities</p>	

PRINCIPAL  
 Geethanjali College of Engg. Tech.  
 Cheeryal (V), Keesara (M), Medchal. Dist. (A.P.) - 501301

April 2021



9<sup>th</sup> Sept 2021.

Due to the continued and contributing efforts of the IIC council the college stood in the band gap of 251 -300 Rank in

**NIRF Ranking!  
For the first time!!**

The screenshot shows the NIRF India Rankings 2021 website. The page title is "India Rankings 2021: Engineering (Rank-band: 251-300)". The table lists institutions in alphabetical order. The college, Geethanjali College of Engineering and Technology, is listed at the bottom of the page with the following details:

Name	City	State
Geethanjali College of Engineering and Technology	Kannur	Kerala

- Diversified representation in the IIC established at the institute from industry, Interdisciplinary & Departments/ Units etc.

Students from different disciplines: 8  
Faculty from Different disciplines: 13  
Different types of Industries: 4

**B. Brief mention of key functionaries at the IIC Institute**

- **President: The principal of the college, Prof Udaya Kumar Susarla** is the president of the IIC council. He directs suggests and guides in framing the policies and through his contacts/networks helps find the resource persons for all the events.
- Vice President
- **Convenor: Dr. Anil Puppala**, the convenor of the IIC council at the college chalks out the overall yearly plan, coordinates and directs all coordinators of the incubation cell and innovation council
- Coordinators:

Name	Dept	Designation	Coordinator
OVPR Siva Kumar	ECE	Professor	Internship Activity Coordinator, IPR Activity Coordinator
Dr. Spandana	ECE	Assoc Prof	NIRF Coordinator, Member
Dr. Harsha Praneeth	CE	Assoc Prof	Member
Sudarshan Rikka	ME	Assoc Prof	Member
Dr. Madhuri Bayya	EEE	Associate professor	Member
Dr. S. Vallisree	ECE	Associate	Start up Activity

**PRINCIPAL**  
Geethanjali College of Engg. Tech.  
Cheeryal (V), Keesara (M), R.R. Dist. (A.P) 501 301

2	Xilinx Vivado Software	75 Licenses	For system design and simulation for Xilinx FPGA
3	Xilinx Zynq – Zybo Boards	Two	For system design using Xilinx FPGA
4	Spartan 3 CPLD/FPGA trainer kits	18 kits	For hardware implementation of logic using Xilinx FPGA
5	Computers	20	Acer Veriton M200-i3
6	Xilinx ISE 9.2i	Perpetual licenses	For system design and simulation for Xilinx FPGA

Students can use Raspberry Pi, Cambridge University Workbook, Reference materials on Sensors, training kits on Arduino.

v The faculty members provide support to help the student's progress to create different projects in view for the development of a society.

v Students can be able to use many free resources like WiFi, Arduino Boards, Raspberry Pi Boards, GSM Module, GPS Module, different types of sensors and many more.

COE in IoT and ES has a Laboratory with the following facilities.

Ø High speed WiFi connectivity.

Ø Computers with Programming and Simulation software tools like Keil, Proteus, Arduino IDE and Raspbian OS.

Ø Server facility for IoT and Cloud Computing.

Ø Reference books.

v Sensors:

- IR, PIR, Temperature and Humidity, Pressure, Vibration, Ultrasonic, PH, Pulse, Temperature, Soil Moisture, LDR, Rain fall, Wind flow, Water flow
- Water level, Colour, Smoke/gas/alcohol, Proximity, Tilt, Gyroscope, Fire, Eye blink, Accelerometer, Finger print, Sound

v Actuators and switches

- DC motor-5v, DC motor-12v, Motor driver, Stepper motor, Servo motor-180d, Servo motor-360d, LEDs, LCD, 7-segment display, Push button switches, Key pad
- Rack and pinion
- Relays

  
**PRINCIPAL**  
 Geethanjali College of Engg. Tech.  
 Cheeryal (V), Keesara (M), R.R. Dist. (A.P.) - 501 301



- Amount grant or fund supported to student & Faculty lead Innovations, start-ups and IPR

**IPR: 3,60,000**

**Total Amount of Funds spent on Innovative student/faculty projects: 98,772/-**

- No. of Technology Transfer and Commercialisation happened

Out of 16 patents filed, there was one patent to which a local industry showed interest in procuring the licences and mass producing it. The patent is co-owned by the college.



- F. Highlight few best IIC Faculty/Student members and their achievements/ Rewarded for the innovations at different forum  
[Profile of few faculties with 2-3 line of their achievements]

Mr. Sunny Raj – IIC student Member – Best Idea award in JHUB Innovation challenge across the state of Telangana

Dr. Madhuri Bayya – Faculty – Coordinator for the Impact Lecture series proposed to be conducted for which we got approval from AICTE.

Dr. Anil Kumar Puppala – Faculty and convener – Gave invited mentor talk at SkillEduVarsity Hyderabad

- G. Highlight selected best Innovations & images with mention of inventor/innovation name

- H. Highlight selected start-ups established by students/faculties with mention of founder/cofounder name

Company Name	Founder	Co-Founder	Co-Founder	CIN Number
Zweirad Electric Private Limited	Mr. Rahul Reddy (Student)	Mr. Manish (student)	Aadhari Santosh (faculty)	U34300TG2021PTC150123
Retro-E Vehicles	Mr. Yashwanth	Dr. Radhika Dora		U29190TG2021PTC149993

PRINCIPAL  
Geethanjali College of Engg. Tech.  
Cheeruvu (V), Keeravani (R), R.R. Dist. (A.P.) - 501 301



- Founder Mr. Sandi Rahul Reddy – Zweirad Electric Pvt, Ltd.

*The hackathons and ideathons that are being organised by the institute are helping us to showcase our talents/innovative ideas*

- Sunny Raj Student CSE –II Year – Winner of JHuB Innovation Challenge throughout the state of Telangana

M. Images

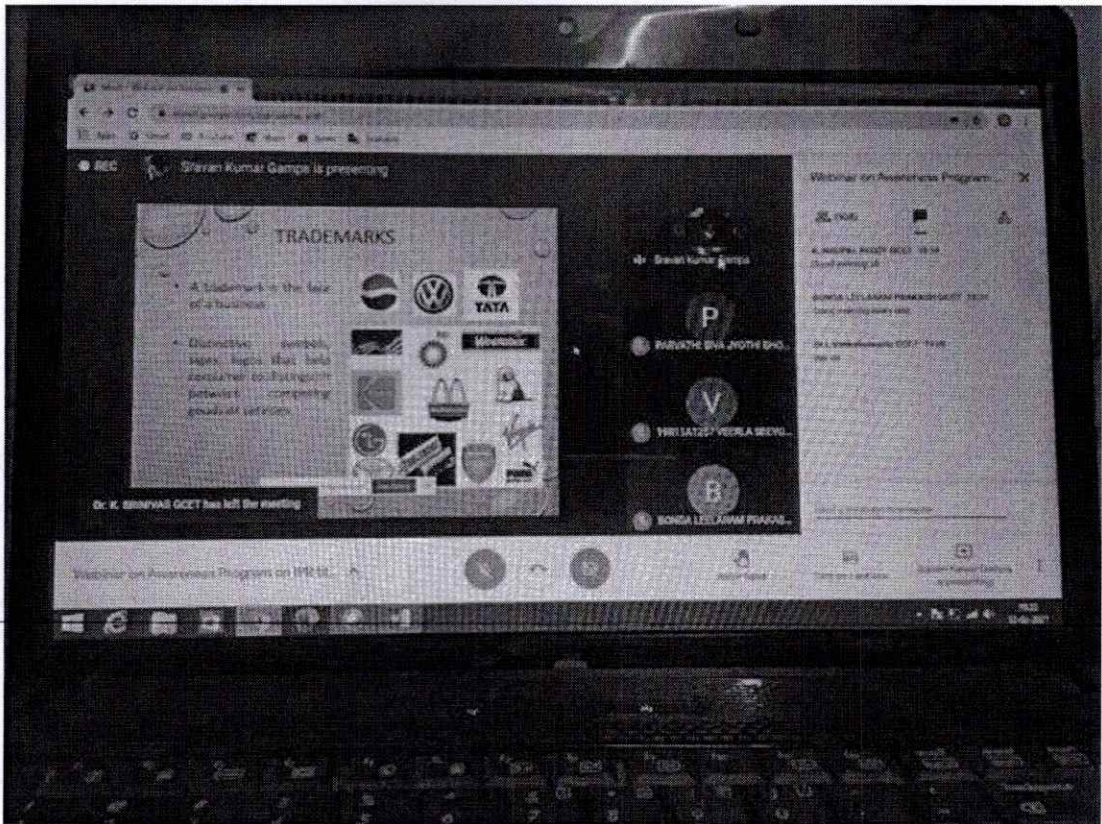
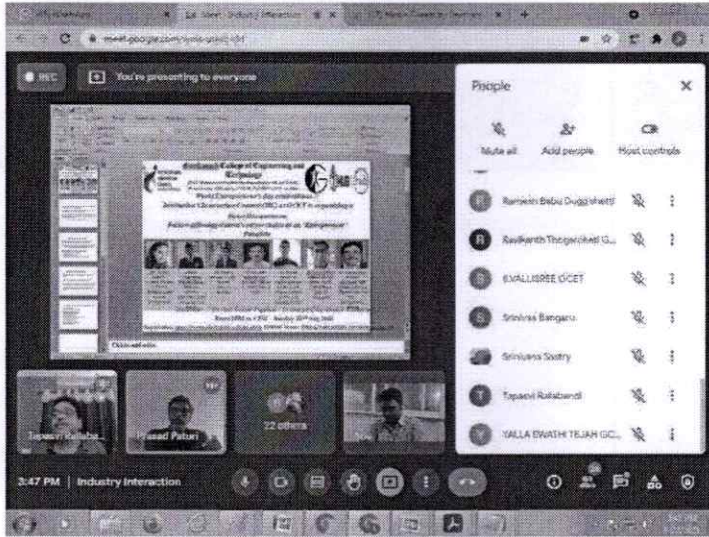

PRINCIPAL  
Gaethanjali College of Engg. Tech.  
Chceryal (V), Kaesara (M), R.R. Dist. (A.P.) - 501 301



Photographs of some of the Projects (continued...)

Solar Powered Automatic Seed Sowing Machine – 2019

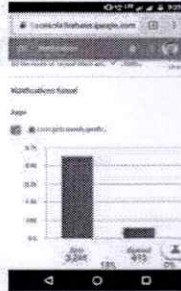
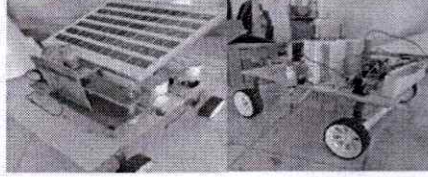

Geethanjali College App

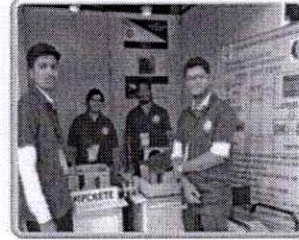

Hempcrete – 2019  
Shortlisted at Regional level and Participated in  
Chhatra Vishwakarma Awards – 2019 National  
Level

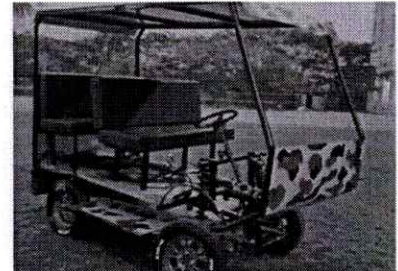
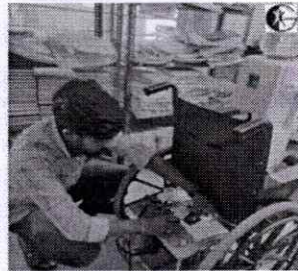

Power Generation from stored Hydrel Power  
(Alternate Energy Systems 2019-20)

UAVs at Society of Automotive Engineers Competition 2018

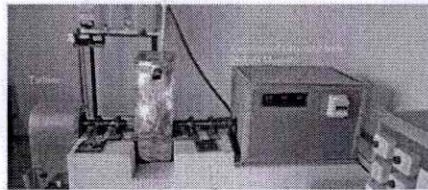

\*Two of the above converted into a startup company in the above picture

N. Contact

Principal:

Dr. Udaya Kumar Susarla B.E., M.E., M.Tech (Hons), PhD  
Principal  
Geethanjali College of Engineering and Technology,  
Cheeryala (V), Keesara (M),  
Medchal Dist. Telangana, Hyderabad - 501301  
Cell: +91-9912744988;

Convener  
Anil Kumar Puppala Ph.D.  
(State University of New York at Buffalo, New York)  
Professor, Dept of EEE,

PRINCIPAL  
Geethanjali College of Engg. Tech.  
Cheeryala (V), Keesara (M), R.R. Dist. (A.P.) - 501 301



## **Geethanjali College of Engineering and Technology**

CHEERYAL (V), KEESARA (M), Medchal DIST-501301, Telangana

**Report**

**On**

**IIC Council Meeting- Review of Q3 progress and Planning of Q4**

**Quarter:- Quarter IV**

**Date: 5<sup>th</sup> Jun 2021**

**Type:- IIC Calendar Activity**

As the university is still not allowing the students to come to the college, in the state of Telangana, the council meeting was held in the absence of the student council members.

**Faculty present:**

All the faculty IIC council members were present

**PRINCIPAL**  
Geethanjali College of Engg. Tech.  
Cheeryal (V), Keesara (M), R.R. Dist. (A.P.) - 501 301



10	Mr. Sandeep	psandeepk.me@gcet.edu.in
11	A. RAGHU RAMA CHANDRA	raghuramachandra.eee@gcet.edu.in
12	Dr. Nagamani	<u>nagamani700@yahoo.com</u>

PRINCIPAL  
Geethanjali College of Engg. Techn.  
Cheeryal (V), Keesara (M), R.R. Dist. (A.P.) - 501 301



## Agenda

The points that were discussed

- Activates that are already covered in Q1, Q2 and the activities that are needed to be covered. Need based analysis for students and startups registered at the incubation center.
- Identifying Resource persons for the activities
- Coordination with JHuB incubator
- Coordination with Startups and company secretary for legal services.

  
PRINCIPAL  
Geethanjali College of Engg. Tech.  
Cheerpal (V), Keesara (M), R.R. Dist. (A.P.) - 501 301.





## Geethanjali College of Engineering and Technology

*(UGC Autonomous Institution Accredited by NBA & NAAC,  
Permanently Affiliated to JNTUH, ISO 9001:2015 certified)  
Cheeryal (V), Keesara (M), Medchal Dist. 501301*



### Report of the Toycathon – Digital Version

22-26 Jun 2021

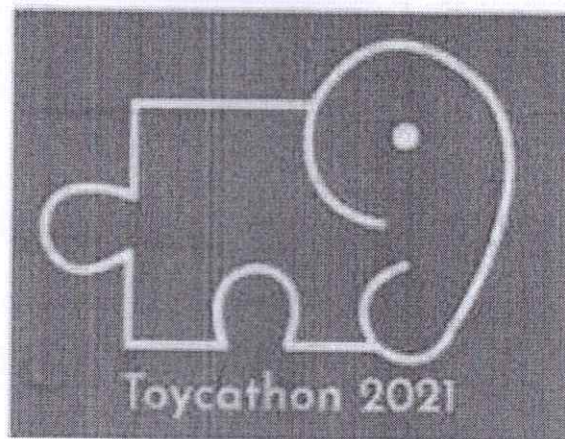

Geethanjali College of Engineering and Technology got the opportunity to collaborate with AICTE- MoE, to cohost the Toycathon – Physical and Digital versions. To this effect, an email communication from innovation officer at AICTE was received on 28<sup>th</sup> Apr 2021 to assign Single Point Of Contact (SPOC) for this purpose.

  
PRINCIPAL

Geethanjali College of Engg. Tech.  
Cheeryal (V), Keesara (M), R.R. Dist. (A.P.) - 501 301

# Geethanjali College of Engineering and Technology

CHEERYAL (V), KEESARA (M), Medchal DIST-501301, Telangana

## Circular

12<sup>th</sup> Jan 2021

AICTE is conducting a nationwide Hackathon related to 'toys'.

Prizes worth 50 Lakhs are up for grabs! Prizes are ready to be claimed!!

There are three tracks under which an individual can submit the idea for a toy.

As a student of Higher Educational Institution a student can team up with others and form a team of minimum three and maximum six and must have a mentor.

Toys should focus the Indian heritage/culture/ethos/promote vedic math/help physically challenged/support Missions like swatch bharath, BetiBachao-Padhao/Climate Change'Digital India.

What does a student need to do ?

Team up with a minimum of three or a maximum of 6 and identify a mentor

Team lead has to Register at <https://toycathon.mic.gov.in/>

Submit idea in the .PPT format available in the website.

Last date to submit the idea: 20<sup>th</sup> Jan 2021, but earlier you submit an idea the better will be the chances as the ideas coming at a later stage may seem to be cliché/stereotype.

Some of the ideas/tips:

- A pre-programmed 'Robotic toy' for teaching BharathNatyam/Kuchipudi/Karate...this is for the kids to gain some interest in those dances at early age so that he/she shows interest to learn them at a later stage : Disciplines needed: Mechanical, Electronics, Electrical, an individual with a knowledge of these dances/karate.
- Students are advised to speak to their grandparents about cultural games and observe the kids in the neighborhood to see what is binding his/her attention in a 'toy'.

### **Template of the ppt:**

Slide1: Title of the Idea

Slide 2: About the idea

Slide 3: Create the toy story

Slide 4: Some creativity included in the toy

Slide 5: Team Profile

  
PRINCIPAL  
Geethanjali College of Engg. Tech.  
Cheeryal (V), Keesara (M), R.R. Dist. (A.P.) - 501301

  
Principal



**Teams who submitted Ideas to TOYCATHON - AICTE**

<b>Title</b>	<b>Names of the Team Members</b>	<b>Roll No.</b>
Bharat Yatrik	A Sai Krupa, T Vishnu, B Abhishek	18R11A0550, 18R11A0592, 18R11A0554
Yatra Nritya	Pallavi	18R11A0243
	Manikanta	19R11A0535
	A.Uday	19R11A0301
	P.Sumanth	18R11A05D1
	CH.Akshitha	19R11A04FO
	T.Vasavi sri lakshmi	19R11A04J9
CROSS CARD GAME	N.KEVIN M.AFREEN MANASA NAGA	19R11A05M6 18R11A0581 18R11A0310 20R15
	Anchuri Harish kumar gupta	18R11A0364
	K.Ashok Gajapathi Raju	18R11A05B7
	M.Vamshi yuvaraj	20R15A0217
	P.Abhishek	19R11A04H6
	Tadem Manvitha	19R11A05D9

Principal  
 Sreehanjali College of Engg. Techn.  
 Anaparthi, N. Arcuru (M), R.R. Dist. (A.P.) - 501301



Geethanjali

Phone : 9182058187  
Website: www.geethanjaliinstitutions.com  
info@gcet.edu.in

# Geethanjali College of Engineering and Technology

## AUTONOMOUS

(Accredited by NAAC "A" Grade; ECE, CSE, EEE & ME, B.Tech Programs Accredited by NBA;  
Approved by AICTE, New Delhi; Permanently Affiliated to JNTUH)  
Sy. No. 33 & 34, Cheeryal (V), Keesara (M), Medchal District. - 501 301.

From  
The Principal,  
Geethanjali College of Engineering and Technology  
Cheeryal,  
Hyderabad

11<sup>TH</sup> Jan 2021

To  
The Coordinator,  
TOYCATHON2021  
AICTE-MIC

Subject: Request to consider Geethanjali College of Engineering and Technology, Hyderabad as a Nodal Center – TOYCATHON.

Greetings from Geethanjali College of Engineering and Technology!

We are an Autonomous Institution recognized by AICTE with NAAC "A" grade and all the programs (except Civil Engineering) are NBA accredited.

We are glad to let you know that AICTE-SCO has teamed up with us and organized Chhatra Vishwakarma regional convention on 13<sup>th</sup> Dec 2019 (Enclosure 1,2).. We are associated with JHub JNTUH and have an Institution Innovation Council (IIC) as per ministry of Education and organized 36 Hr Nationwide Hackathon in 2018, 2019 and 2020 respectively.

This letter is to express our willingness and preparedness to host the TOYCATHON 2021 as we possess and can offer all the facilities as mentioned by MIC in the email dated 10<sup>th</sup> Jan 2021.

Sincerely,

Principal

**PRINCIPAL**

Geethanjali College of Engg. and Tech.

Cheeryal (V), Keesara (M), Medchal Dist. (T.D.) - 501 301.

Prof Dr. Udaya Kumar Susarla.



Principal  
Geethanjali College of Engg. Tech.  
Cheeryal (V), Keesara (M), R.R. Dist. (A.P.) - 501 301

Sponsored by **TEJA EDUCATIONAL SOCIETY, HYDERABAD**

Office : Sy. No. 33 & 34, Cheeryal (V), Keesara (M), Medchal Dist. - 501 301.

Phones : 9182058196, 9182058194





Phone : 040-23340113, 040-23345071  
Email : scro@aicte-india.org  
Website : www.aicte-india.org

G.C.E.T/73/2019-20, Dt. 27/12/19



सत्यमेव जयते

अखिल भारतीय तकनीकी शिक्षा परिषद

(भारत सरकार का एक संवैधानिक निकाय)  
(मानव संसाधन विकास मंत्रालय, भारत सरकार)

ALL INDIA COUNCIL FOR TECHNICAL EDUCATION

(A Statutory Body of the Govt. of India)  
(Ministry of Human Resource Development, Govt. of India)

South Central Regional Office

Block No. : 201 to 204 & 221 to 224, 2nd Floor,  
Swarna Jayanthi Commercial Complex,  
Ameerpet, Hyderabad - 500 038

SCRO-AICTE/CVA-2019/ 504

Date: 18.12.2019

To

The Principal/MD,  
Geethanjali College of Engineering and Technology,  
Cheeryal Village,  
Keesara Mandal,  
Hyderabad,  
Telangana 501301.

Respected Sir,

I wish to thank you wholeheartedly and express my sincere gratitude for hosting the Regional Convention of Chhatra Vishwakarma Awards - 2019 on 13.12.2019 at your Institute.

It would be than appropriate to mention that the warmth of AICTE, SCRO, Hyderabad has received from your end was overwhelming.

I also convey my sincere thanks to the Principal, Dr. Anil Puppala and other members of your team for their help.

I once again thank you for extending all your help for the above event and look forward to have such cooperation in future.

Thanking you,

Regards,

(DR. AMIT VISHWASRAO SALUNKHE)  
ASST. DIRECTOR & REGIONAL OFFICER

PRINCIPAL  
Geethanjali College of Engg. Tech.  
Cheeryal (V), Keesara (M), R. & Dist. (A.P.) - 501301



सूचना का अधिकार



Phone : 040-23340113, 040-23345071  
Email : scro@aicte-india.org  
Website : www.aicte-india.org



सत्यमेव जयते

## अखिल भारतीय तकनीकी शिक्षा परिषद

(भारत सरकार का एक संवैधानिक निकाय)

(मानव संसाधन विकास मंत्रालय, भारत सरकार)

### ALL INDIA COUNCIL FOR TECHNICAL EDUCATION

(A Statutory Body of the Govt. of India)

(Ministry of Human Resource Development, Govt. of India)

#### South Central Regional Office

Block No. : 201 to 204 & 221 to 224, 2nd Floor,  
Swarna Jayanthi Commercial Complex,  
Ameerpet, Hyderabad - 500 038

SCRO-AICTE/CVA-2019/4834

Date: 06.12.2019

To

The Principal/MD,  
Geethanjali College of Engineering and Technology,  
Cheeryal Village,  
Keesara Mandal,  
Hyderabad,  
Telangana 501301

Sir,

**SUB:** Conducting Chhatra Vishwakarma Awards – 2019 – Reg.

All India Council for Technical Education (AICTE) is planning to hold a competition of "Chhatra Vishwakarma Awards – 2019 (Outstanding Innovative Team Awards) in the Southern Region on 13<sup>th</sup> December 2019.

All Institutions/Students as approved by AICTE are covered under this award. Awards will be given in following categories:

- Category – I: Chhatra Vishwakarma awards for Outstanding Innovative Team (Students & Mentor).
- Category – II: Utkrisht Sansthan Vishwakarma Award for exemplary Institutional Intervention.

The above awards aims to recognize and honour innovative work of the students displaying exceptional skills in different categories to provide the innovative solution to the problem statement. The theme for this year's award is "How to enhance the income of a Village".

Date finalized is 13<sup>th</sup> Dec, 2019.

The requirements for holding the above event are:

- 1) The No. of groups participating is 32 (about 100 to 120 students).
- 2) Accommodation for outstation students who might come in a day early.
- 3) 32 Tables with chairs and with Power outlets and Wi-Fi.
- 4) About 8 – 10 Judges in groups of two will walk through the demonstration.
- 5) One room for the judges for discussion and selection of teams.
- 6) Dinner for the out station students who come on previous night i.e., on 12.12.2019 and also breakfast on 13.12.2019 morning for them.
- 7) On 13<sup>th</sup> morning snacks and Tea/Coffee, afternoon lunch and evening Snacks and tea for all the participants and also for judges.

Cont. Page - 2



सुमना का  
अधिकार

PRINCIPAL  
Geethanjali College of Engineering and Technology,  
Cheeryal Village, Keesara Mandal, Hyderabad - 501301



Nodal Center login was created by AICTE to upload resources, man power, attendance of the participants, attendance of the jury etc.

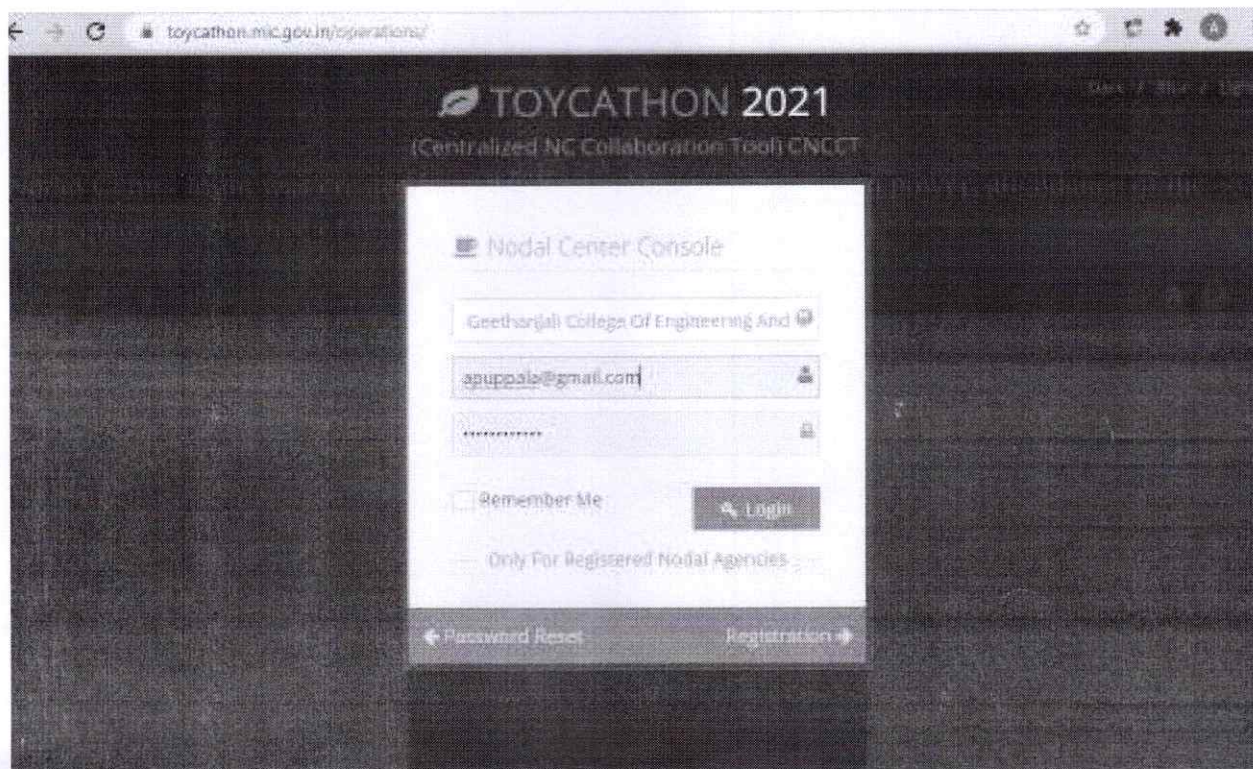

The organizing team had received training through online sessions from AICTE.

The following are the highlights of the meeting/training conducted on

Minutes of the meeting of Toycathon with AICTE:

**Minutes of the meeting of Toycathon with AICTE Dated 27<sup>th</sup> May 2021.**

- AICTE wants to Interact with only one SPOC from each college/Institute/University.
- **Two sets of 'evaluation teams' and 'volunteering teams' have to be constituted to cater to Digital Hackathon' and the Physical Hackathon.**
- **Two mentors each (a total of four) for the two platforms – Digital and Physical Hackathons have to be identified. Volunteers(four – five) for the 'Physical Hackathon' will have to attend the college.**

  
**PRINCIPAL**  
Goethanjali College of Engg. Tech.  
Chaeryal (V), Keerasa (M), R.R. Dist. (A.P.) - 501 303

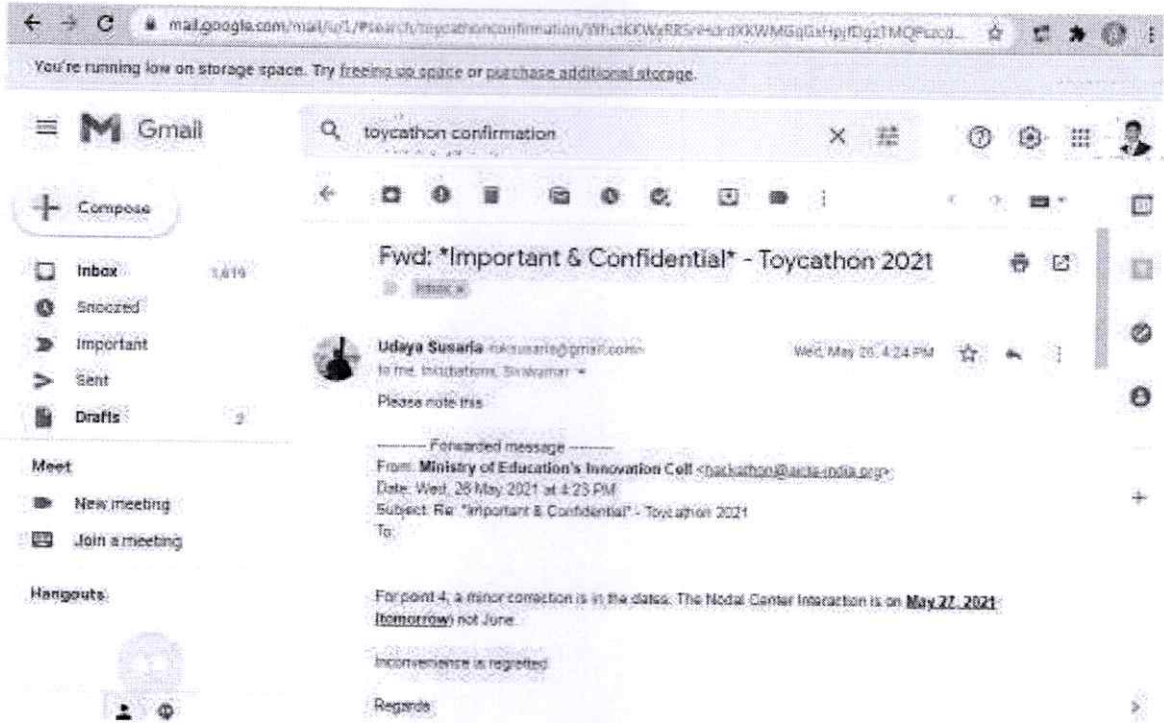

Dr. Anil Kumar Puppala, I/C of Incubation Center at GCET was nominated as the SPOC representing GCET. Apart from him the team, the following is the team that is appointed for this purpose.

Name of the Faculty	Designation	Department	Role assigned
Dr. Anil Kumar Puppala	Professor	EEE & I/C of Incubation Center	Main SPOC
Dr. SomaShekar	Professor	CSE	SPOC
Dr. OVPR Siva Kumar	Professor	EEE	SPOC
Mr. Abhilash Katakam	Placement officer	Training and Placement	SPOC - Mass Media
Mr. Vijay Bhaskar Reddy	Assoc Professor	CSE	SPOC - Social Media Contact
Mr. Naresh Babu	Asst Prof	CSE	IT Coordinator
Mr. Vikas	Asst Prof	CSE	IT Coordinator
Mr. Gowtam	Asst Prof	ME	IT Coordinator
Mr. Anand	Asst Prof	ECE	IT Coordinator
Mr. Sandeep	Asst Prof	ME	IT Coordinator

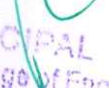
  
**PRINCIPAL**  
 Goethanjali College of Engg. Tech.  
 Chaeryal (V), Keosara (M), R.R. Dist. (A.P.) - 501 303.



Nodal Center login was created by AICTE to upload resources, man power, attendance of the participants, attendance of the jury etc.

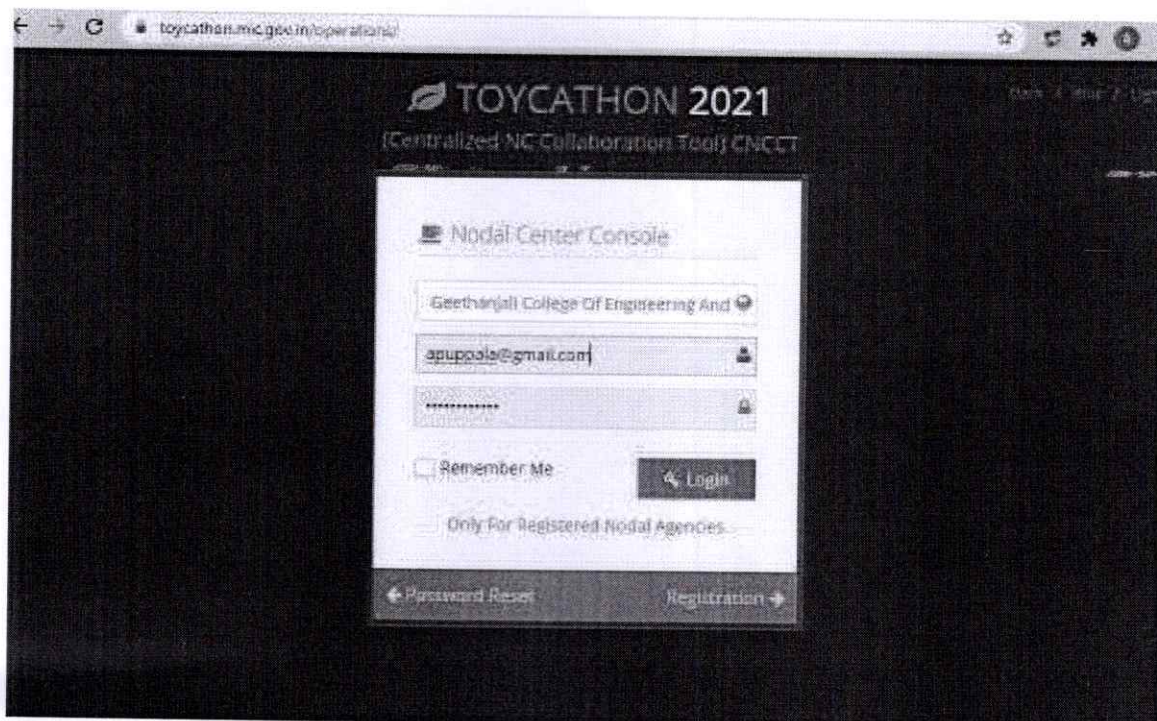

The organizing team had received training through online sessions from AICTE.

The following are the highlights of the meeting/training conducted on

Minutes of the meeting of Toycathon with AICTE:

**Minutes of the meeting of Toycathon with AICTE Dated 27<sup>th</sup> May 2021.**

- AICTE wants to Interact with only one SPOC from each college/Institute/University.
- Two sets of 'evaluation teams' and 'volunteering teams' have to be constituted to cater to Digital Hackathon' and the Physical Hackathon.
- Two mentors each (a total of four) for the two platforms – Digital and Physical Hackathons have to be identified. Volunteers(four – five) for the 'Physical Hackathon' will have to attend the college.

  
**PRINCIPAL**  
Geethanjali College of Engg. Tech.  
Chacryal (V), Keesara (M), R.R. Dist. (A.P.) - 501 301

- **Eight evaluators for physical Hackathon and eight evaluators for digital hackathon – with different backgrounds (eg. Alumni/industry/academia) have to be identified.** Evaluators for both categories shall be trained to have uniformity in evaluation.
- Two separate sets of trainings for the evaluators (each of 5-7 days) will be scheduled for Digital and Physical Hackathons.
- The team identified for 'Physical Hackathon' – must come to college during the event but can attend the training sessions online.
- The team identified for 'Digital Hackathon' need NOT come to college but have to attend the training sessions and cater to the needs of the participating teams through online mode.
- **The volunteering teams will have to identify the requirements of each team – The team lead's phone numbers are shared by AICTE.**
- If costly equipment it is not available – procurement on 'Rental basis' is suggested rather than buying/procuring them.
- Procurement is recommended through GeM portal (Government e - Market place).
- **Will have to identify - Chief Guest for the prize distribution function – 26<sup>th</sup> June (most likely).**
- Institute can advertise that it is partnering with Government of India to organize ToyHackathon – Advertisement templates shall be shared shortly.
- **Institute has to raise funds for hospitality of mentors/evaluators (boarding and lodging)**
- Food expenses shall be reimbursed neither for the students nor for the mentors/organizers.
- **There shall be a live interaction of Honorable Prime Minister with students during 22-24 June. Institute has to make video conferencing arrangements for this purpose without any glitches.**
- **For conducting the Physical Hackathon: Sanitizers, packed food etc., have to be planned by the institute.**
- For conducting Physical Hackathon: Institute can plan a budget in the range of RS.2.5L to Rs.3.5L. An advance of Rs.2L – Rs.2.5L may be released to the institute. Finer details will be given by the Director, finance in a separate session (with all dos and don'ts)

Key Leverage for the Institute from the conduct of the Hackathon:

1. **College logo and name will be placed on AICTE web page that mentions the partnership for Toyathon.**
2. **College can issue a Press Release (PR) about the above partnership.**
3. **College can conduct a separate function by inviting a chief guest etc., and create public awareness**
4. **College can raise funds for hospitality through sponsors**

Another training session was held a week later on

To summarize some of the important points that were discussed yesterday:

PRINCIPAL  
Geethanjali College of Engg. Tech.  
Cheerl (V), Keosaru (R), R.R. Dist. (A.P.) - 501 303



- Assigning evaluators who also act as mentors in the morning session shall be done by MIC. We may nominate a few evaluators and they may be assigned to a different NC.
- Attendance format - for the participating teams will be shared by MIC.
- We may prepare to have a 'dry run' with the teams before the actual date.
- Main role of the NC is to coordinate the students to be on-board of the communication/video communication tool when the mentors/evaluators are scheduled for evaluation or mentoring.
  - For an NC with fifteen teams, approximately five-six volunteers are needed to call the team leaders and ensure that they are 'on-boarded' depending the number of evaluator panels assigned to each NC.
  - All members must be present for a demo of the tool on Tuesday 15<sup>th</sup> Jun 2021.
  - Verify the team's school issued ID cards or government issued ID cards
  - Monitor the channel, if there is any communication happening between the teams (we cannot monitor their coding) between each mentoring/evaluation session.
- Logging through Mobile is not supported yet. Either a laptop/computer. Minimum requirements/specifications of the computer shall be shared by MIC soon.
- Video recording shall be done team wise during mentoring/evaluation.
- Links of youtube for valedictory/Inaugural sessions shall have to be posted in the dashboard by the SPOC of the NC.
- NCs may get sponsorships and hence may encourage participating teams with goodies.
- Nobody can recast the interaction with the Prime Minister.
- **'Prize money' and 'three winners per NC' – Need a bit more clarity on that.**

\*Action items are highlighted in bold.

Roles and responsibilities to host toycathon was shared by AICTE, which is attached as the appendix

Training sessions for the participants which was scheduled and conducted by AICTE, is circulated among not only among participants but also for the entire GCET

  
 PRINCIPAL  
 Geethanjali College of Engg. Tech.  
 Chaciyal (V), Kasaragod (M), K.R. Dist. (A.P.) - 501 301.



# Toycathon 2021

## TOYCATHON-2021 TRAINING SESSIONS

Sr. No.	Date	Topic
1	4th June 2021 and Onwards	INTRODUCTION AND INDIAN CULTURE IN TOY'S/GAMES
2		PLAY FACTOR IN TOY/GAMES
3		ELEMENTS / DESIGN THINKING FOR A TOY
4		DEVELOPING AND MANUFACTURING
5		MARKETING / IP

## DESIGN MENTORS DETAILS

 <b>Dr. Harish Arora</b> Assistant Professor and Co-ordinator DCE, BHU Department Department of Architecture	 <b>Aashir Gans</b> Faculty National Institute of Design Department Toy and Game Design	 <b>Padmaja Singh</b> Co-Founder & Partner Creative Director Ratanratan Advertising Department Advertising
 <b>Rohit Kumar Shaw</b> Graphic Designer Sr. Student, DCE, BHU University Department Department of Applied Arts	 <b>Utkarsh Pat</b> Faculty Sri Sri Harpur Institute of Art, Design & Technology, Barampore Department Visual Communication	 <b>Shubhi Agrawal</b> Entrepreneur and Co-Founder of Syc Department Marketing and branding
 <b>Shivangi Gupta</b> Research Scholar Banarus Hindu University Department Department of Applied Arts, Faculty of Visual Arts	 <b>Ankit Srivastava</b> Web & App Developer Design Innovation Center Banarus Hindu University, Varanasi Department Design Innovation Center	 <b>Shilpi Prajapati</b> Research Scholar Visual Arts, Banarus Hindu University Department Applied Arts
 /mhrdinnovation	 @mhrd_innovation	 /mhrdinnovationcell

**PRINCIPAL**  
 Geethanjali College of Engg. Tech.  
 Cheeryal (V), Keeravani (M), R.R. Dist. (A.P.) - 501 307



**Finance committee of AICTE also held a meeting. This is the chat transcript**

from Dr.S.SENTHIL KUMAR NPSBCET to everyone: 2:14 PM

for digital mode,what about the honorarium to experts!!

from undefined undefined to everyone: 2:14 PM

any hardware requirement for digital mode?

from Sarim Moin to everyone: 2:18 PM

Institute needs to procure the components but in case of a situation of a lockdown in the nodal center state then they the nodal center can ask the student teams to procure the items and submit the bills. But the nodal center committee need to evaluate the bills critically for these cases.

from Raj Hakani to everyone: 2:20 PM

Proper bill means GST no ?

from Sarim Moin to everyone: 2:20 PM

Honorarium guidelines will be shared shortly. By the time please identify domain experts

from somayajulu to everyone: 2:20 PM

For procurement are GFR to be followed

from undefined undefined to everyone: 2:20 PM

By when we will get the list of the items to procure?

from Sarim Moin to everyone: 2:24 PM

We have asked the teams to submit the BoM form (Bill of Material). The deadline is 5th June and once we receive the component, you will be to see in your respective portals.

from Prof. Namita Gupta to everyone: 2:25 PM

Are Dates of physical hackathon final or may change?

from Kumari, IISc Bangalore to everyone: 2:25 PM

We need to know the details of the project of teams (digital) to decide on Evaluator. When would that be available? And when will we know the MIC appointed Evaluator, and the person's expertise? It will help in identifying evaluator from our side of complimentary expertise.

  
**PRINCIPAL**  
Geethanjali College of Engg. Tech.  
Cheeryal (V), Keesara (M), R.R. Dist. (A.P.) - 501 301

from Raj Hakani to everyone: 2:26 PM

We are from Govt University

from Sarim Moin to everyone: 2:26 PM

A total of 3 winners will be declared at each nodal centers (including physical and digital teams)

from Dr. Manoj Kumar Gopaliya to everyone: 2:27 PM

Good Afternoon to everyone.

This is Dr. Manoj Kumar Gopaliya from CGU-ODISHA.

from Raj Hakani to everyone: 2:27 PM

We are from Govt University, should we follow govt norms to procure component like GEM or invite min 3 quotation ?

from Sarim Moin to everyone: 2:28 PM

The team details along with project details can be accessed at the master sheet parked at nodal center repository link

from Atul Barve to everyone: 2:29 PM

Whether AICTE will provide any kind of appreciation letter to experts & organizing team?

from Raj Hakani to everyone: 2:29 PM

Student will procure it / or Institute has to procure component

from Sarim Moin to everyone: 2:30 PM

MIC AICTE will provide E-Certificates to the experts and organizing team.

from Raj Hakani to everyone: 2:30 PM

After Hack A Thon should we take back component or student will take away it

from Atul Barve to everyone: 2:30 PM

thanx sarim sir

from Sarim Moin to everyone: 2:30 PM

Institute needs to procure the components but in case of a situation of a lockdown in the nodal center state then they the nodal center can ask the student teams to procure the items and submit the bills. But the nodal center committee need to evaluate the bills critically for these cases.

PRINCIPAL  
Geethanjali College of Engg. Tech.  
Cheerup (V), Keeravaram (R), R. Dist. (A.P.) - 501 301



from Raj Hakani to everyone: 2:32 PM

If Institute procure components then Name of billing material will be Inst. name or AICTE MIC CELL

from Sushmita Narayana to everyone: 2:32 PM

Prof Sushmita here would like to ask a question

from Sarim Moin to everyone: 2:32 PM

The components are the property of AICTE-mic. Guidelines and decision regarding the same will be intimated later.

from Abudhahir to everyone: 2:36 PM

SOP and FAQ shall be prepared and sent.

from Raj Hakani to everyone: 2:38 PM

CA Certificate bill can we include in this expense or inst fund

from Raj Hakani to everyone: 2:39 PM

Govt Inst has to do certify from external CA

from Raj Hakani to everyone: 2:41 PM

Sir We have some of Component is available and same requirement raised by team then can we allow them to use our component or we have to procure new one

from MHRD's Innovation Cell to everyone: 2:44 PM

@sarim moin- can i call you now

from Raj Hakani to everyone: 2:45 PM

what about Consumable component like wires clay etc because it will be consume during to develop prototype

from Devesh Walia to everyone: 2:56 PM

good afternoon

from yogesh vanjari to everyone: 2:57 PM

thank you

from Raj Hakani to everyone: 2:59 PM

  
**PRINCIPAL**  
Geethanjali College of Engg. Tech.  
Cheerani (V), Keerana (M), R.R. Dist. (A.P.) - 501 201

we are request you gave saction order as soon as possible and list of component becasue in Govt inst we need min 10 days to procure it

A poster was created for this purpose.

  
**PRINCIPAL**  
Goetharjalli College of Engg. Tech.  
Cheerayal (P), Kuvempu Dist - 574 201, Karnataka





**GEETHANJALI**  
COLLEGE OF  
ENGINEERING & TECHNOLOGY



A Proud Moment for Everyone Associated  
**GEETHANJALI COLLEGE OF ENGINEERING AND TECHNOLOGY,  
HYDERABAD**

will serve as Nodal Centre for



**Toycathon 2021**

by Govt. of India

Let's Get Our Acts Together to  
**Make it a Grand Success**

<https://tinyurl.com/gcet-toycathon2021>



**Mr. G. R. Ravinder Reddy**  
Chairman & Director



Guest of Honor: **Mr. Sharath Chandra K.**  
Co-Founder Butterfly Fields Pvt. Ltd.



Chief Guest: **Mr. Sathesh Reddy K.**  
President Telangana Industrialists Federation.

**Participating Ministries**



**PRINCIPAL**  
Geethanjali College of Engg. Tech.  
Cheeryal (V), Keesara (M), R.R. Dist. (A.P.) - 501 301







**Chief Guest:**

Mr. Sudheer Reddy K., President Telangana Industrialists Federation.

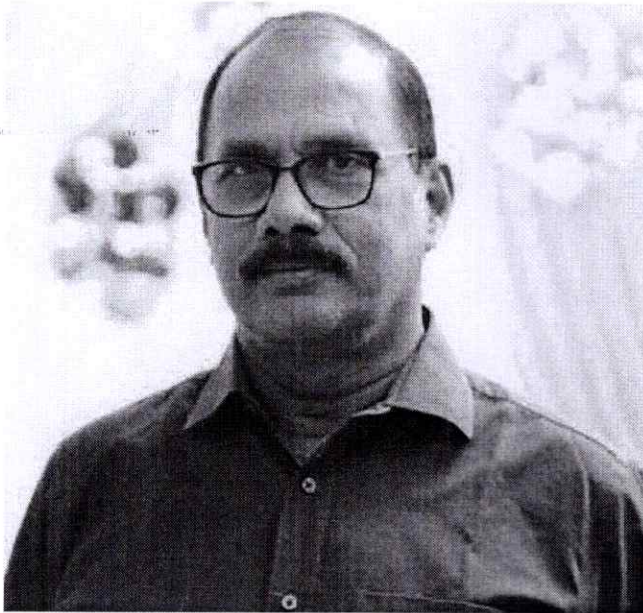

**Guest of Honor:**

Mr. Sharath Chandra K. Co-Founder Butterfly Fields Pvt Ltd. Company is involved in designing and implementing Hands on Curriculum & Innovative Teaching Learning Methodologies for K-12. They Work to conceptualise, design & craft Fun Learning Toys for Kids from 2 to 15 years of age The Assortment is across STEAM, Puzzles, Reading and Writing, Magnetic tiles, Hobby, Model Making Kits . Ranging from INR 299 to INR 4000 or USD 15 to 150

He Worked as Analyst at Kpmg From Jan 2003 – Jun 2003 and as an Analyst at arthur Andersen From Jul 2001 – Jan 2003 He is educated from IIT Bombay in Chemical Engineering and IIM Ahemdabad

Thank you Sharat Garu:

Definitely, regarding the space, we are planning to have the space which will have pre-incubation unit, where they will have experiential learning. So, yes we are planning to have the makers space where they do the modeling followed by simulation and take it all the way to fabrication will be done by the

PRINCIPAL  
Goetharjall College of Engg. Tech.  
Chennel (V), Raesara (M), R.R. Dist. (A.P.) - 501 301.

students itself. The pre-incubation space. I am visualizing the pre-incubation space would be more like a war zone/workshop.

**Chief Guest:**

Mr. Sudheer Reddy Kondaveeti., is the founder President of Telangana Industrialists Federation. He was awarded Bachelors Degree in civil engineering from JNTU, Hyderabad and during this period of engineering studies only, he was an active participant of the movements emerged for the purpose of obtaining UGC recognition for JNTU and was a part and parcel of the success in obtaining UGC recognition to JNTU by representing the student movements with out compromising to the studies and achievements.

After completion of engineering he joined technical education department of Government and served as lecturer & head of the dept for 14 long years. Possessing the independent views of the life style and with a noble cause of providing employment for the unemployed youth, Mr. Sudhir Reddy has resigned his government job and established an Industry in the year 1996 at IDA Cherlapally, Hyderabad .

Mr. Sudhir Reddy has served cherlapally industries association having 900 industrial units as Secretary & president. He also served as chairman of Industrial area local authority and was instrumental in transforming IDA Cherlapally in to ZERO GARBAGE & Dust Bin free estate and was applauded by several state and central government organisations by winning many clean and green awards and also guided many other industrial estates to implement this policy.

associations under his leadership also played a crucial role in the formation of separate state of telangana

TIF under the able leadership of Sudhir Reddy has played important role in bringing an innovative industrial policy for Telangana (TS-IPass) by giving valuable inputs to govt . Apart from above Mr. sudhir reddy has played important role in shaping an exclusive MSME park near Ramoji film city in association with Govt of telangana in an area of 460 acres accommodating 450 independent units providing employment to 30,000 people , with an investment of 2200 crores by the govt.

PRINCIPAL  
Geethanjali College of Engg. Tech.  
Cheeryal (V), Keesara (M), N.R. Dist. (A.P.) - 501 301



He was also a member of the delegation of the Government to study the industrial policies existing in the other countries and also accompanied our current Chief Minister KCR Garu to Singapore to study the policies followed by their government.

## Appreciation Letters



Phone: 9182058187  
Website: www.geethanjalinstitutions.com  
info@geet.edu.in

### Geethanjali College of Engineering and Technology AUTONOMOUS

(Accredited by NAAC 'A' Grade, ECE, OSE, EEE & ME, B.Tech Programs Accredited by NBA)  
Approved by AICTE, New Delhi; Permanently Affiliated to JNTUH)  
Sy. No. 33 & 34, Cheruvu (V), Keesara (M), Medchal District, - 501 301

1<sup>st</sup> July 2021

#### Letter of Appreciation

This is to acknowledge and appreciate Mr. Kondaveeti Sudheer Reddy, president of Telangana Industrialists Federation (TIF) for gracing the inaugural ceremony of 'Tocathon' as Chief Guest at Geethanjali College of Engineering and Technology (GCET). GCET was selected as one of the few nodal centers to partner with AICTE to conduct it from 22<sup>nd</sup> - 26<sup>th</sup> Jun 2021, in partnership with All India Council for Technical Education (AICTE).

Tocathon was a three day Hackathon which was centrally organized by AICTE in collaboration with six ministries of Government of India. Mr. Sudheer Reddy's inputs to the participants were very valuable.

I/C Incubation Center

Dr. Anil Kumar Puppala

Principal

Dr. Udaya Kumar Susarla  
PRINCIPAL  
Geethanjali College of Engg. and Tech.  
Cheruvu (V), Keesara (M), Medchal Dist. (T.S.)-501 301

PRINCIPAL  
Geethanjali College of Engg. Tech.  
Cheruvu (V), Keesara (M), R.R. Dist. (A.P.) - 501 301



Phone: 9182658134  
 Website: www.geethanjali.edu.in  
 info@geethanjali.edu.in

**Geethanjali College of Engineering and Technology**  
**AUTONOMOUS**

(Accredited by NAAC 'A' Grade; ECE, CEE, EEE & ME, E-Tech Programs Accredited by NBA;  
 Approved by AICTE, New Delhi; Permanently Affiliated to JNTUH)  
 Sy. No. 33 & 34, Cheeryal (V), Keesara (M), Medchal District - 501 301

1<sup>st</sup> July 2021

**Letter of Appreciation**

This is to acknowledge and appreciate Mr. K. Sharat Chandra, Co-founder of Butterfly Fields Pvt. Ltd. for gracing the inaugural ceremony of 'Toycathon' as Guest of Honor at Geethanjali College of Engineering and Technology (GCET). GCET was selected as one of the few nodal centers to partner with AICTE to conduct it from 22<sup>nd</sup> - 26<sup>th</sup> Jun 2021, in partnership with All India Council for Technical Education (AICTE).

Toycathon was a three day Hackathon which was centrally organized by AICTE in collaboration with six ministries of Government of India. Mr. K. Sharat Chandra inputs to the participants and GCET's incubation center were very valuable.

I/C Incubation Center

  
 Dr. Anil Kumar Puppala

Principal

  
 Dr. Udaya Kumar Susarla  
**PRINCIPAL**  
 Geethanjali College of Engg. and Tech.  
 Cheerjal (V), Keesara (M), Medchal Dist. (TS)-501 301

Sponsored by TEJA EDUCATIONAL SOCIETY, HYDERABAD

Office: Sy. No. 33 & 34, Cheeryal (V), Keesara (M), Medchal Dist. - 501 301  
 Phones - 9182658134, 9182658134

Inaugral Schedule of the Toycathon:

  
**PRINCIPAL**  
 Geethanjali College of Engg. Tech.  
 Cheerjal (V), Keesara (M), R.R. Dist. (A.P.) - 501 301





**Geethanjali College Of  
Engineering and Technology**  
CHEERVAL KEESARA MEDICAL  
TELANGANA 501 301



**Toycathon-2021**  
22<sup>nd</sup> - 24<sup>th</sup> June 2021

**TOYCATHON NODAL CENTER**

**Day 1 - Tuesday, 22<sup>nd</sup> June 2021**

<b>8:00 AM - 8:45 AM</b>	Local Inauguration by Nodal Center <b>Inauguration of 'Grand Finale of Toycathon-2021' at Institute level.</b> <b>Welcome Address:</b> G.R.Rao Reddy, Chairman Geethanjali College Of Engineering And Technology <b>Guest of Honor:</b> Mr. Sharath Chandra K. Co-Founder Butterfly Fields Pvt Ltd. <b>Chief Guest:</b> Mr. Sudheer Reddy K. President Telangana Industrialists Federation.
<b>9:00 AM to 10:00 AM</b>	National Inauguration Address by Hon'ble Ministers, AICTE Officials and Representatives of Ministries. Detailed MQM to be shared. Inauguration Ends.
<b>10:00 AM</b>	Toycathon-2021 Begins.
<b>11:00 AM - 1:00 PM</b>	First Round of Mentoring Sessions. (10-15 minutes per team)
<b>1:00 PM - 1:45 PM</b>	Lunch Break
<b>1:45 PM onwards</b>	Coding / Toy Building continues
<b>4:00 PM to 6:00 PM</b>	First Round of Evaluation

**Day 2 - Wednesday, 23<sup>rd</sup> June 2021**

<b>8:30 AM onwards</b>	Coding / Toy Building continues
<b>11:00 AM - 1:00 PM</b>	Second Round of Mentoring Session (17-20 minutes per team)
<b>1:00 PM to 1:45 PM</b>	Lunch Break
<b>1:45 PM onwards</b>	Coding / Toy Building continues
<b>4:00 PM - 6:00 PM</b>	Second Round of Evaluation

**Day 3 - Thursday, 24<sup>th</sup> June 2021**

<b>8:30 AM onwards</b>	Coding / Toy Building continues
<b>9:30 AM - 10:50 AM</b>	Third Round of Mentoring Session (Last & Final Round of mentoring)
<b>11:00 AM - 12:15 PM</b>	Address of Hon'ble PM and interaction with student teams
<b>12:15 PM - 1:00 PM</b>	Coding Continues
<b>1:00 PM to 1:45 PM</b>	Lunch Break
<b>1:45 PM onwards</b>	Coding / Toy Building continues
<b>4:00 PM</b>	Coding / Toy Building Stops
<b>4:00 PM - 6:00 PM</b>	Third Round of Evaluation (Last & Final Round of evaluation)
<b>6:00 PM to 7:00 PM</b>	Submission of results by panellists.

**Day 4 - Saturday, 24<sup>th</sup> June 2021**

Results Announcement

[www.geethanjaliinstitutions.com](http://www.geethanjaliinstitutions.com)

Appreciation Letters to Chief Guest and Guest of Honor

**PRINCIPAL**  
Geethanjali College of Engg. Tech.  
Cheerval (V), Keesara (M), R.R. V.M. (A.P.) - 501 301





	Technology, Hyderabad			Garje		
GR023	Geethanjali College Of Engineering And Technology, Hyderabad	7	1	Dr. Asha S Manek	ashasm.rvitm@rv ei.edu.in	9945825923
GR023	Geethanjali College Of Engineering And Technology, Hyderabad	7	0	DIWAKER	diwaker@ditunive rsity.edu.in	8077686018
GR023	Geethanjali College Of Engineering And Technology, Hyderabad	7	0	Ancy Antony	ancyjerine@gmail .com	8281604576
GR128	Geethanjali College Of Engineering And Technology, Hyderabad	7	0	Viralkumar Mohanlal Prajapati	viral.itworld@gma il.com	9925127260
GR128	Geethanjali College Of Engineering And Technology, Hyderabad	7	0	RONAK H GADARIA	galaria.ronak@g mail.com	9925474778
GR128	Geethanjali College Of Engineering And Technology, Hyderabad	7	0	Dr S Murugan	murugan.cse@sat hyabama.ac.in	9940217379
GR128	Geethanjali College Of Engineering And Technology, Hyderabad	7	1	Dipak Kulkarni	dbkulkarni@git.ed u	9480456340
GR128	Geethanjali College Of Engineering And Technology, Hyderabad	7	0	Amit Lathigara	amit.lathigara@rk u.ac.in	9925011422

Mass and Social Media Coverage

PRINCIPAL  
Geethanjali College of Engg. Techn.  
Cheeruvu (V), Keusera (M), R.R. Dist. (A.P.) - 501 301

**Tweet**

**Geethanjali Group of Institutions** @geethanjaliites · Jun 23  
Toycathon 2021

@PMOIndia  
@Bharatians  
@EduMinOfIndia  
@mtrd\_innovation  
@toycathon  
@AICTE\_INDIA  
@adishanarabudhe  
@DrPPNishank  
@SanjayDhotreM

#Toycathon #Toycconomy #AtmaNirbharBharat #TeamUpForToys  
#Toycathon2021 #NodalCentre  
#GeethanjaliCollegeofEngineeringandTechnology #GCCTC

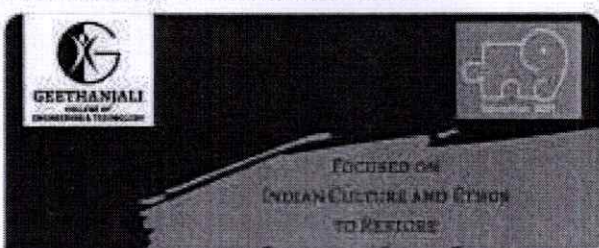

**Relevant people**

- Geethanjali ...** @geethanjaliites Follow  
Striving Towards Perfection...
- PMO L...** @PMOIndia Following  
Office of the Prime Minister of India
- Smriti Z L...** @smritizl... Follow  
Union Cabinet Minister for Textiles and Women & Child Development | MP Amethi Lok Sabha Constituency

**What's happening**

- Politics - Yesterday  
**Supreme Court dismisses plea against**

**Geethanjali Group of Institutions** 106 Tweets Follow

**Geethanjali Group of Institutions** @geethanjaliites · Jun 23  
Toycathon 2021 - Day 2

#Toycathon #Toycconomy #TeamUpForToys #Toycathon2021 #NodalCentre  
#BestEngineeringCollege #bestcollegeinhyderabad #bestcollegeinTelangana  
#GeethanjaliCollegeofEngineeringandTechnology #GCCTC #GCET  
#GeethanjaliInstitutions #Hyderabad



**FreeJaggiNow** 12.6K Tweets

- Tennis - LIVE  
**Follow all the action from Wimbledon 2021**
- Trending with #DanceWithAmir
- COVID-19 - Yesterday  
**Moderna's vaccine gets emergency use authorisation in India**

**Topics to follow**

- Investing** Business & finance Follow X

**PRINCIPAL**  
Geethanjali College of Engg. Tech.  
Cheeryal (V), Keesara (M), R.R. Dist. (A.P.) - 501 301.



## నేటి నుంచి 24 వరకు టాయ్ హాకథాన్ గ్రాండ్ ఫినాలే

కీసరలోని గీతాంజలి ఇంజనీరింగ్ కాలేజీలో ఏర్పాటు  
వైదరాబాద్, జూన్ 21, ప్రభాతవార్త: బొమ్మల వరిశ్రమను  
ప్రోత్సహించడం కోసం అలభారత సాంకేతిక విద్యామండలి(ఎఐసీటీఈ)  
టాయ్ హాకథాన్-2021ను నిర్వహిస్తోంది. టాయ్ హాకథాన్-2021 గ్రాండ్  
ఫినాలేను కీసరలోని గీతాంజలి కాలేజ్ ఆఫ్ ఇంజనీరింగ్లో నిర్వహిస్తు  
న్నారు. గ్రాండ్ ఫినాలేను నేటి నుంచి 24 వరకు నిర్వహిస్తున్నట్లు  
గీతాంజలి ఇంజనీరింగ్ కాలేజీ చైర్మన్ గడ్డం రమీందర్ రెడ్డి తెలిపారు. టాయ్  
ఫినాలేలో భారతదేశంలోని వివిధ ప్రాంతాల నుంచి 30 జట్లు  
పాల్గొననున్నాయి. బొమ్మల వరిశ్రమలో ప్రధానమంత్రి మోదీ ఆలోచన  
వోకల్ ఫర్ లోకల్ మేరకు విద్యా మంత్రిత్వ శాఖ దేశవ్యాప్తంగా మల్టీట్రాక్  
ఇంటర్ మినిస్టీరియల్ టాయ్ హాకథాన్ ఆలోచనను రూపొందించింది.  
టాయ్ హాకథాన్-2021ను విద్యా మంత్రిత్వ శాఖ మరో 5 శాఖలతో కలిసి  
సంయుక్తంగా నిర్వహిస్తోంది. ఇందులో కేంద్ర విద్యాశాఖ నోడల్ ఏజెన్సీగా  
వ్యవహరిస్తోంది. వీటికి సంబంధించిన టాయ్ హాకథాన్-2021 గ్రాండ్  
ఫినాలే నేటి నుంచి 24 వరకు కీసరలోని గీతాంజలి ఇంజనీరింగ్  
కాలేజీలో జరగనుంది.

**వార్త**

Tue, 22 June 2021

<https://epaper.vaartha.com/c/613052>



  
PRINCIPAL  
Geethanjali College of Engg. Tech.  
Cheerayal (V), Keesara (M), R.R. Dist. (A.P.) - 501301.

ఆదిశింధుడు

## నేటి నుంచి 24 వరకు టాయ్ హాకథాన్ గ్రాండ్ ఫినాలే

కేసరలోని గీతాంజలి ఇంజనీరింగ్ కాలేజీలో ఏర్పాటు  
హైదరాబాద్, జూన్ 21, ప్రభావవ్యక్తి: బొమ్మల చరిత్రను  
ప్రోత్సహించడం కోసం ఆలభాదర సాంకేతిక విద్యాలయంలో(పిఎన్.జే.ఈ)  
టాయ్ హాకథాన్-2021ను నిర్వహిస్తుంది. టాయ్ హాకథాన్-2021  
గ్రాండ్ ఫినాలేను కేసరలోని గీతాంజలి కాలేజీ ఆఫ్ ఇంజనీరింగ్లో  
నిర్వహిస్తున్నారు. గ్రాండ్ ఫినాలేను నేటి నుంచి 24 వరకు  
నిర్వహిస్తున్నట్లు గీతాంజలి ఇంజనీరింగ్ కాలేజీ ఛైర్మన్ గడ్డం రమేందర్ రెడ్డి  
 తెలిపారు. టాయ్ ఫినాలేలో భారతదేశంలోని వివిధ ప్రాంతాల నుంచి  
30 జట్లు పాల్గొననున్నాయి. బొమ్మల చరిత్రను ప్రధానమంత్రి మోడీ  
 ఆలోచన బోధన ఫర్ లోకల్ మేరకు విద్యా మంత్రిత్వ శాఖ  
 దేశవ్యాప్తంగా మల్టీటాక్ ఇంటర్ మినిస్ట్రీయల్ టాయ్ హాకథాన్

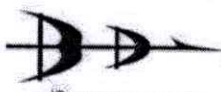

शक्ति का आधार शान-शान  
THE FORCE BEHIND PEACE

ప్రకటన

### 5 లక్షలకు పైగా ఫలితాల వివరాలు (పా. బి.ఎల్)

ముగిసిన సంవత్సరం		
31.03.2020 గడువక కు పూర్వం	31.03.2021 (అడిట్ అయిన)	31.03.2020 (అడిట్ అయిన)
143939.45	191375.95	310487.20
40043.26	34088.11	74245.40
40043.26	34088.11	74245.40
30972.12	25776.52	53490.08
29312.16	24422.19	51328.02
18328.12	18328.12	18328.12
-	250146.60	242354.85
16.90	14.06	29.18

అడిట్

శ్రీ చాణా ఒప్పిడికి చా.గి.65-నుండి వివరించిన ప్రతిభా బోధన

3(6) క్రింద భారత కంప్యూటర్ మరియు అడిట్ గానకలో

అడిట్ కాని అంబిలెట్ మర్చి సమీక్షించి అంబిలెట్ నివారించినది.

ఎం. స్టాక్ ఎక్స్చేంజీల వద్ద చాణాని చేయబడిన అడిట్ అయిన  
నివారణ పత్రానికి అడిట్ అంబిలెట్ ఫలితాల పూర్తి  
పేజీల [www.bdi-india.in](http://www.bdi-india.in) లో లభిస్తాయి.

**భారత్ డి.ఎస్.ఎస్. బి.ఎస్.ఎస్. కలెజ్**  
సం/-  
CME డి.ఎస్.ఎస్. (రిజిస్టర్డ్)  
ప్రైవేట్ మరియు మేనేజ్మెంట్ కలెజ్  
(DIN:08367035)

ఆలోచనను  
పూర్తిచేసింది.  
టాయ్  
హాకథాన్-2021ను  
విద్యా మంత్రిత్వ  
శాఖ మరో 5  
కాలేజీల్లో కలిపి  
నిర్వహించగా  
నిర్వహిస్తుంది.  
అందులో కేంద్ర  
విద్యాశాఖ నోడల్  
ఉత్తరప్రదేశ్  
దేశీయ బొమ్మల  
మార్కెట్లో  
ఇన్ఫో మేషన్స్  
ప్రోత్సహించడమే  
కాకుండా  
కాలేజీలన్నాయి  
మేరకు  
అందించడం.  
టాయ్  
హాకథాన్-2021  
కల్పన టాయ్  
హాకథాన్ను  
మాడు క్రాకర్ల  
నిర్వహిస్తున్నారు.  
విద్య, భారతీయ  
చరిత్ర, సంస్కృతి  
మరియు ఓం  
మంటి ఇతివృత్తాల  
ఆధారంగా  
వినుత్య  
బొమ్మలపై  
14130 బ్యూం  
దాటు, 17.770  
ఫిలిమ్స్ ఆలోచనలు  
ఇప్పటి వరకు  
సమర్పించారు.  
నీటికి  
సంబంధించిన  
టాయ్  
హాకథాన్-2021  
గ్రాండ్ ఫినాలే నేటి  
నుంచి 24 వరకు  
కేసరలోని  
గీతాంజలి ఇంజ  
నీరింగ్ కాలేజీలో  
ఆరగిస్తుంది.

**PRINCIPAL**  
Geethanjali College of Engg. Tech.  
Cheerla (V), Keesara (M), R.R. Dist. (A.P.) - 501301



Some pictures on

Day 1



PRINCIPAL  
Geethanjali College of Engg. Tech.  
Cheeruvu (V), Keesara (H), R.R. Dist. (A.P.) - 501 303.



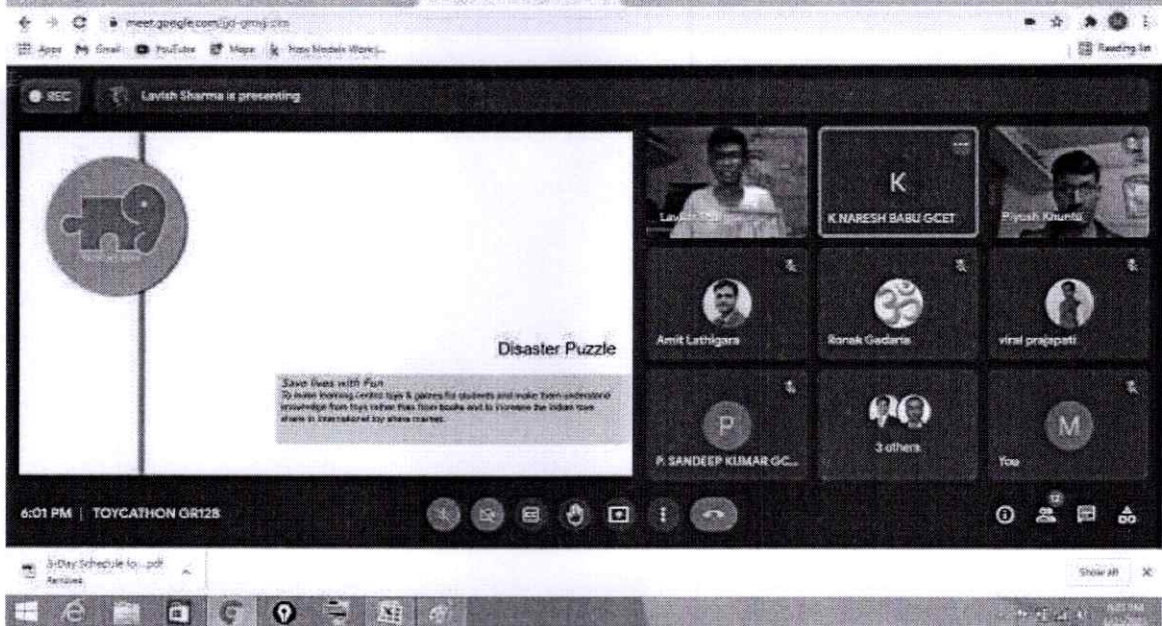

  
**PRINCIPAL**  
 Geethanjali College of Engg. Tech.  
 Chervyl (V), Keasara (M), R.R. Dist. (A.P.) - 501 301



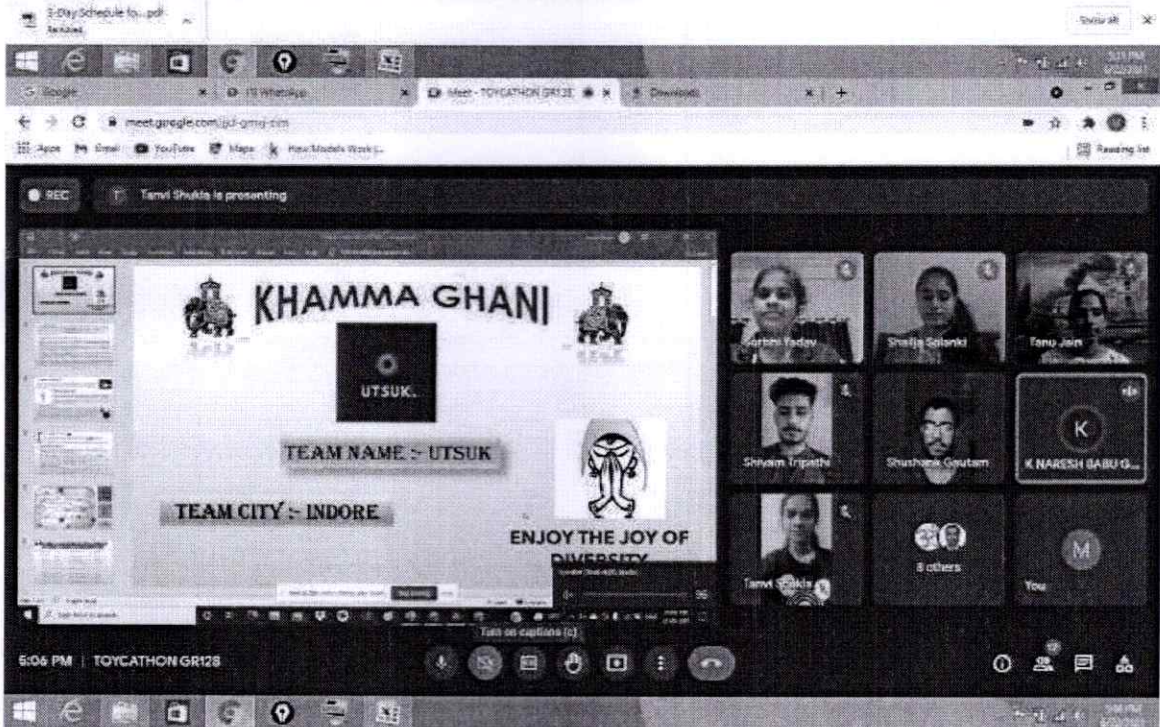
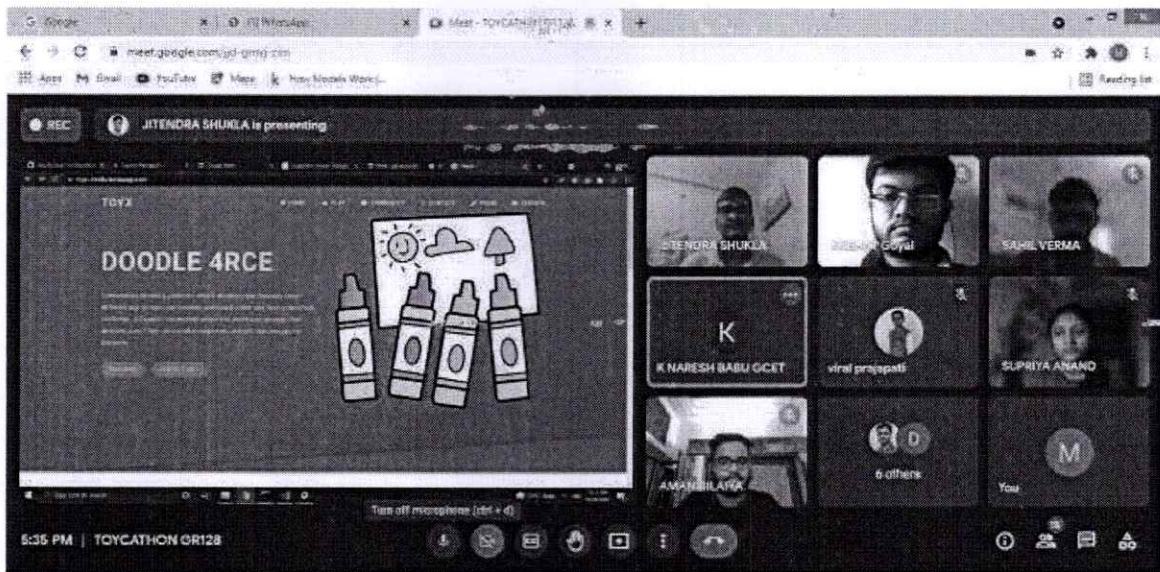

PRINCIPAL  
 Geethanjali College of Engg. Tech.  
 Cheryal (V), Keerasa (H), Khammam (T)



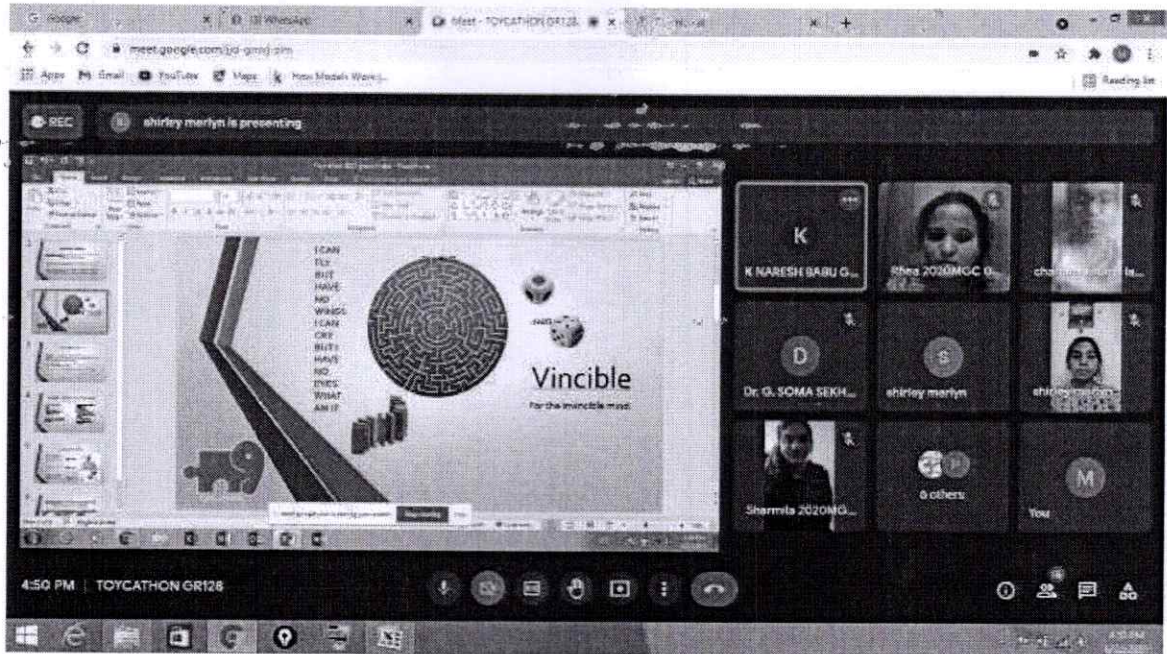

Some picture on Day 2 Mentoring

**PRINCIPAL**  
Geethanjali College of Engg. Tech.  
Cheeryal (V), Kaesara (M), R.R. Dist. (A.P.) - 501 302



meet.google.com/jd-gmg-qm

shirley merlyn is presenting

Vincible  
For the invincible mind

11:48 AM | TOYCATHON GR128

meet.google.com/jd-gmg-qm

Shaija Solanki is presenting

KHM-IT-19

PUC CONDITIONS DECK (HURDLES)

PUC CONDITIONS DECK (POSITIVE POINTS)

POI DECK

11:59 AM | TOYCATHON GR128

*(Handwritten signature)*

**PRINCIPAL**  
Geethanjali College of Engg. Tech.  
Cheeryl (V), Keesara (V), R.R. Dist. A.P. - 501 301



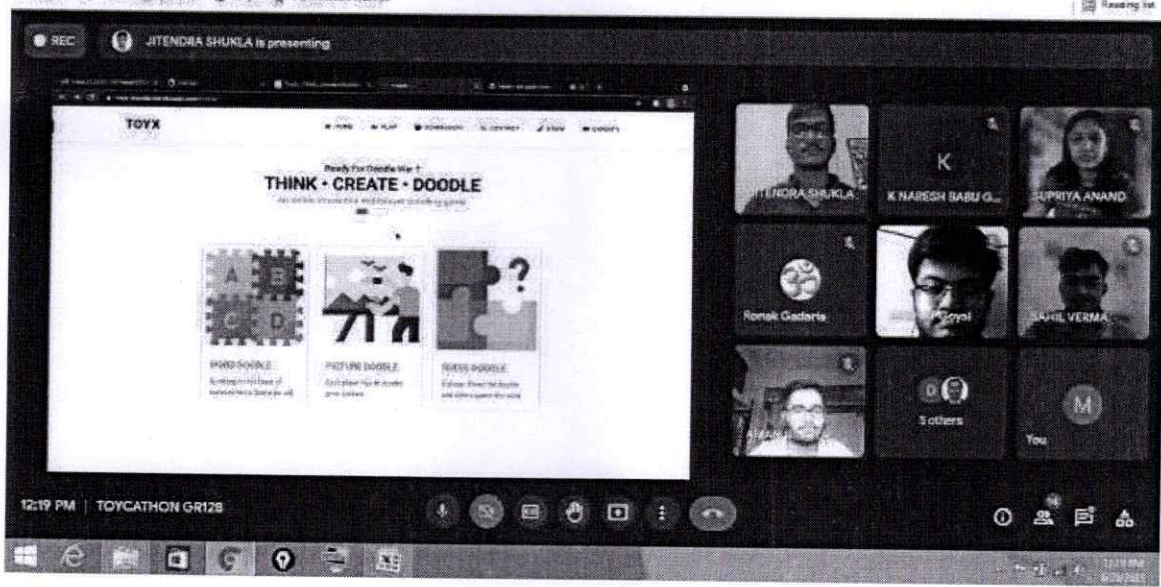
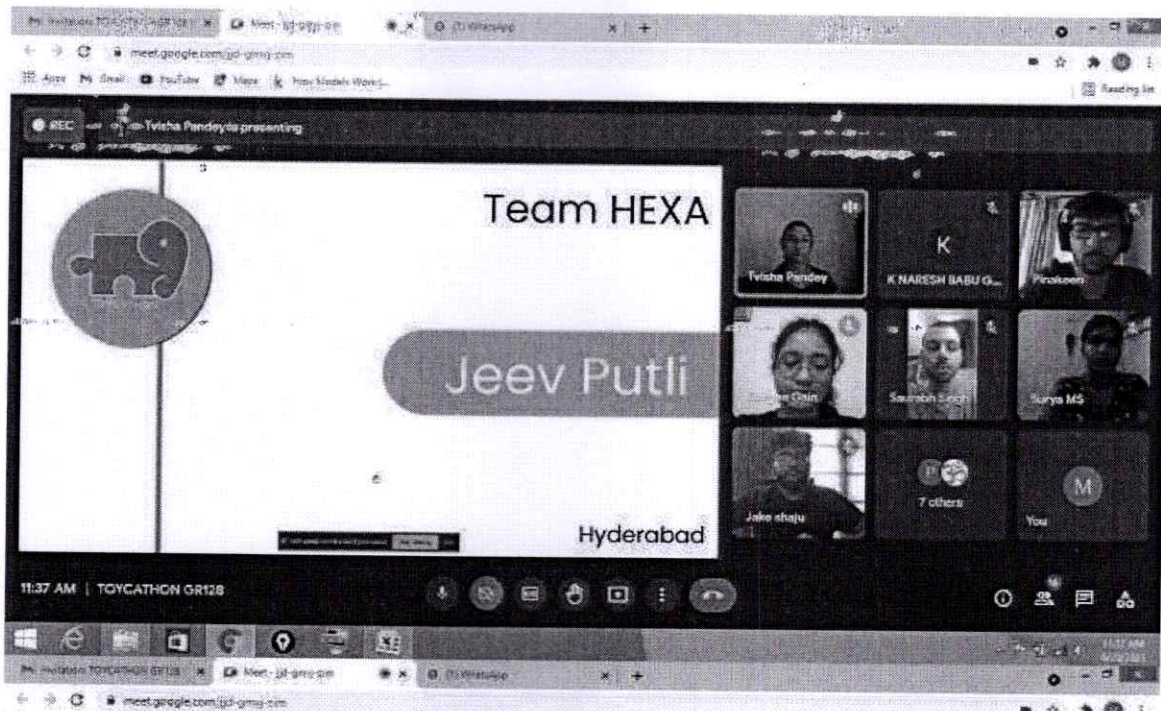

  
 PRINCIPAL  
 Goethanjali College of Engg. Tech.  
 Chervyl (V), Keesari (M), R.R. Dist. (A.P.) - 501 301



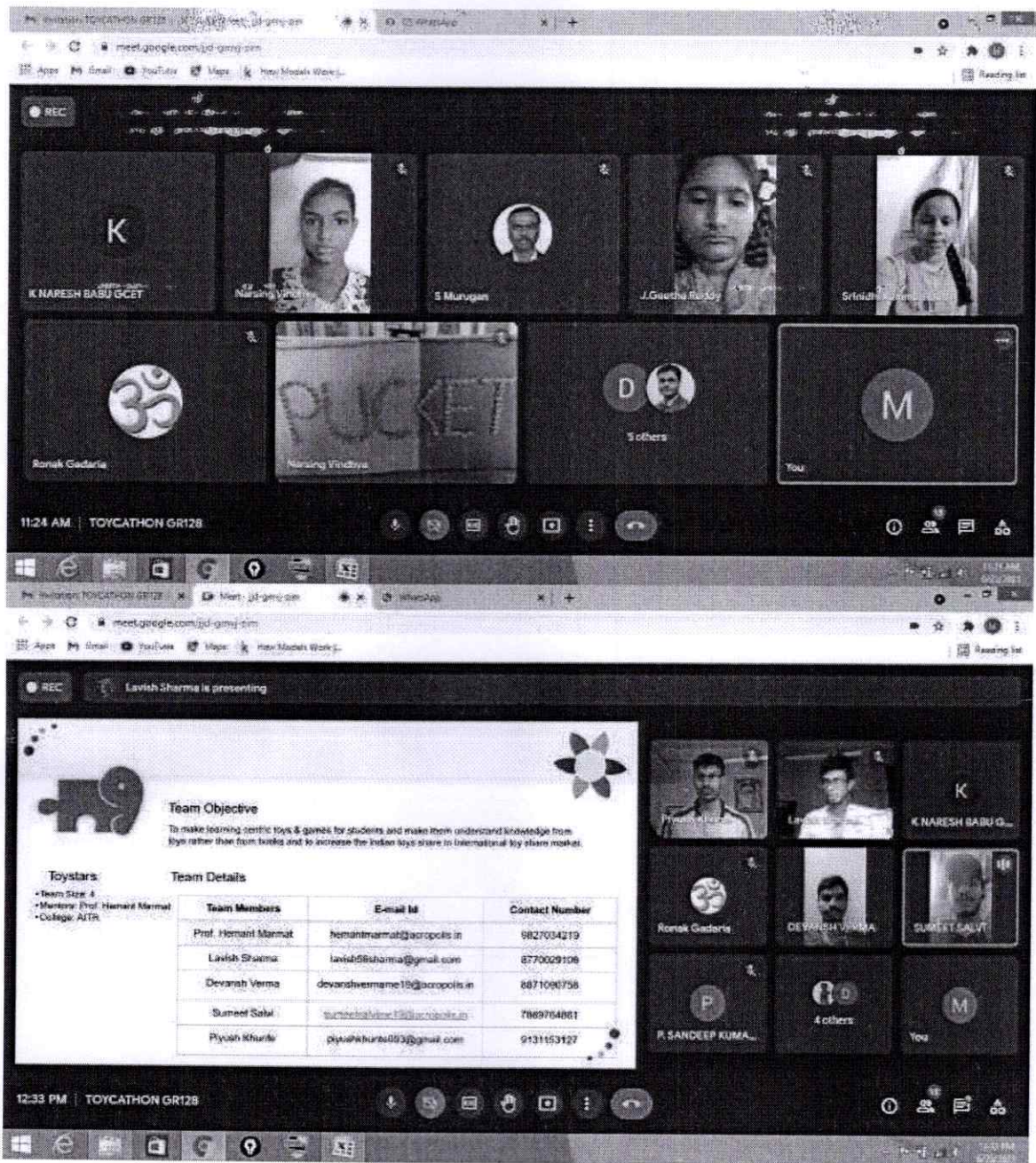

Day 2 Evaluation

PRINCIPAL  
Geethanjali College of Engg. Tech.  
Cheerpal (V), Keshavnagar (M), R.R. Dist. (A.P.) - 501 301



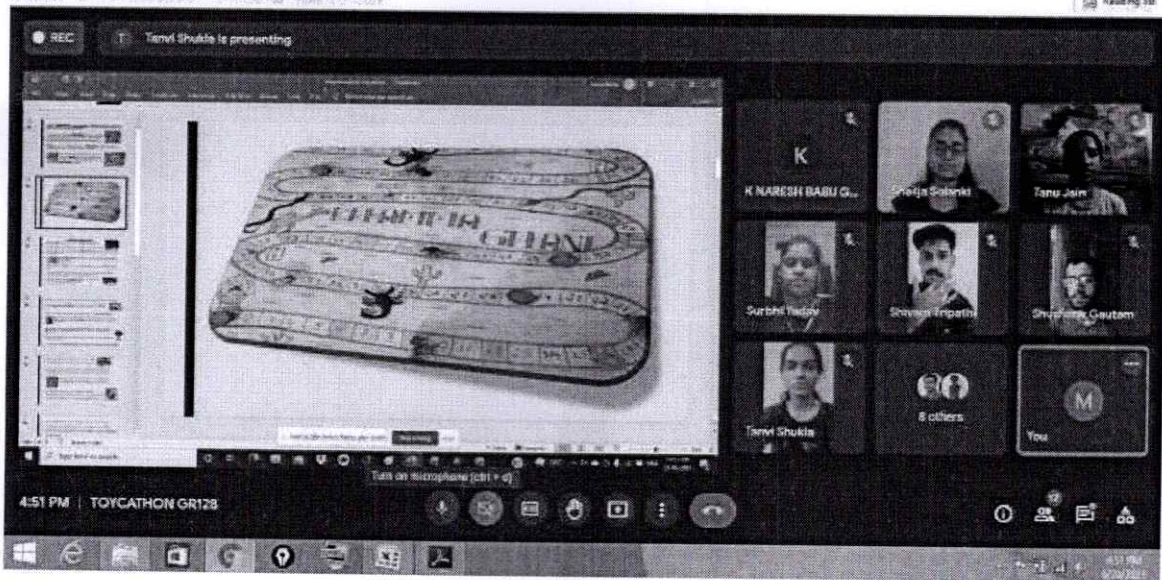
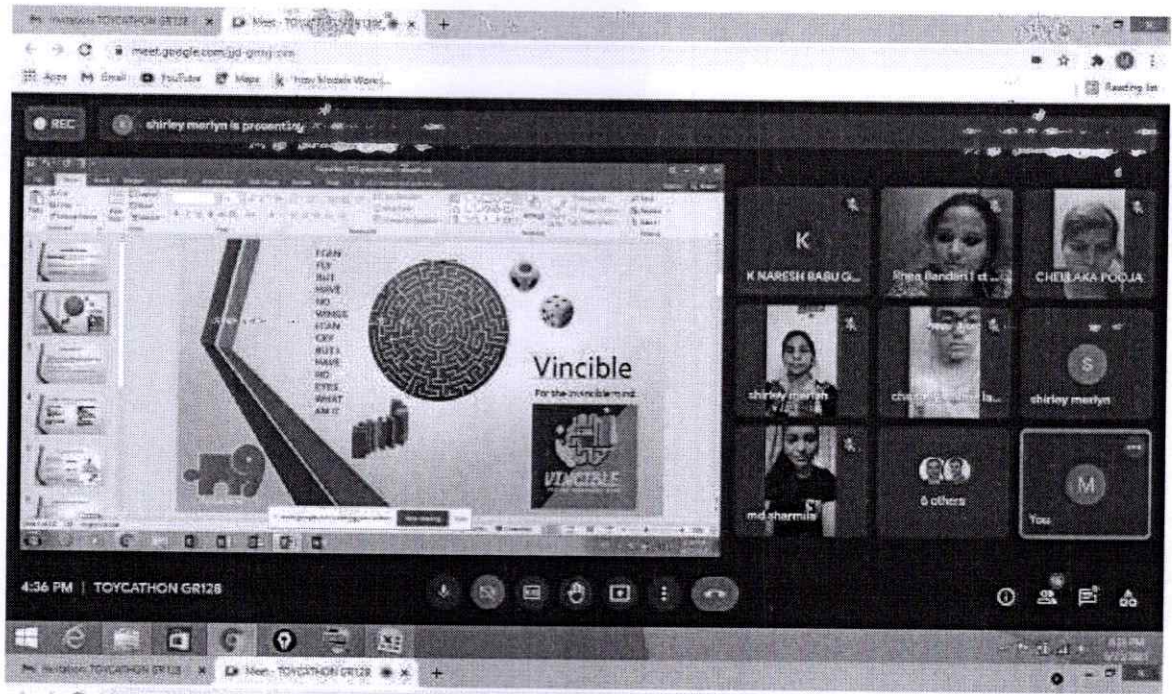

PRINCIPAL  
Goethanjali College of Engg. Tech.  
Cheerpal (V), Kasurba (M), R.R. Dist. (A.P.) - 501 302



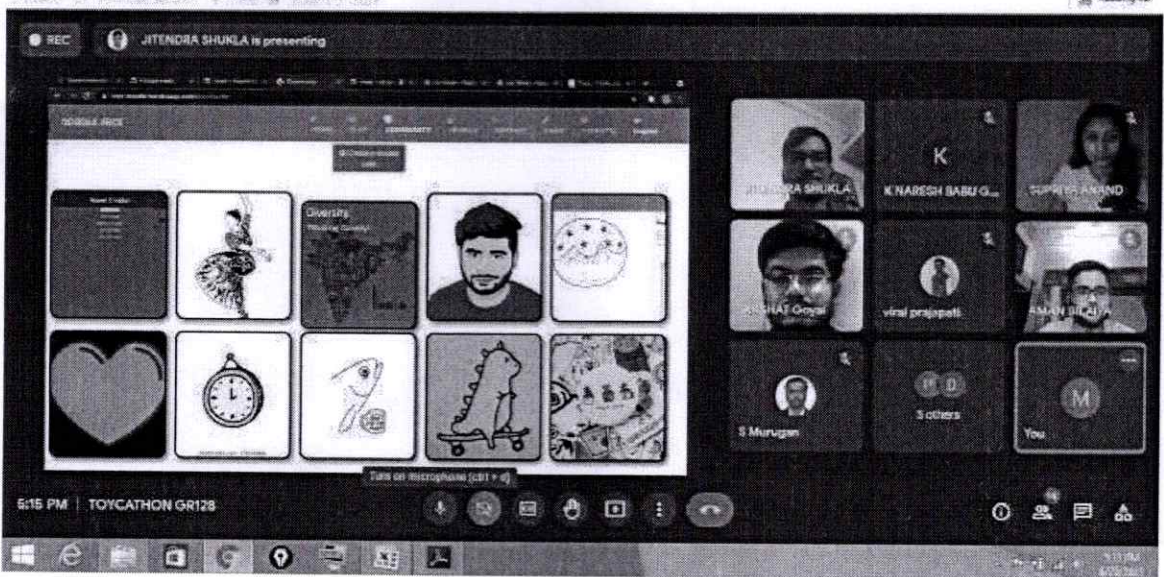
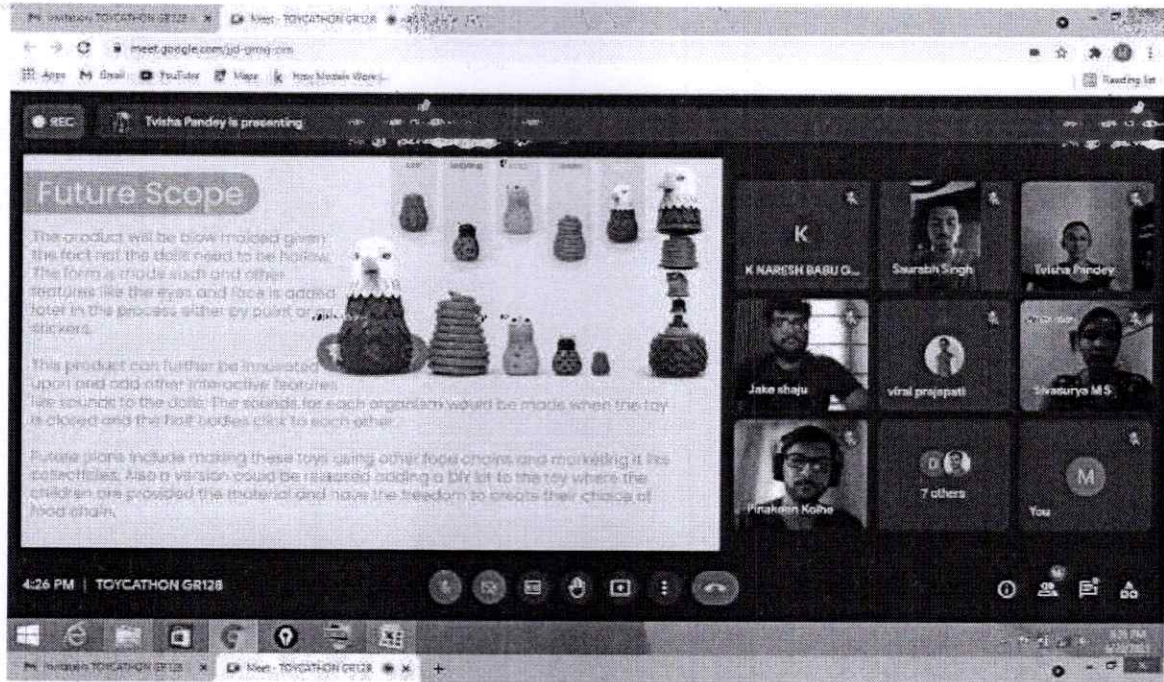

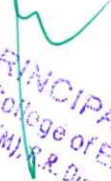
  
**PRINCIPAL**  
 Gesthanjali College of Engg. Tech.  
 Cheeryal (P), Koesara (M), S.R. Dist. (A.P.) - 501 301



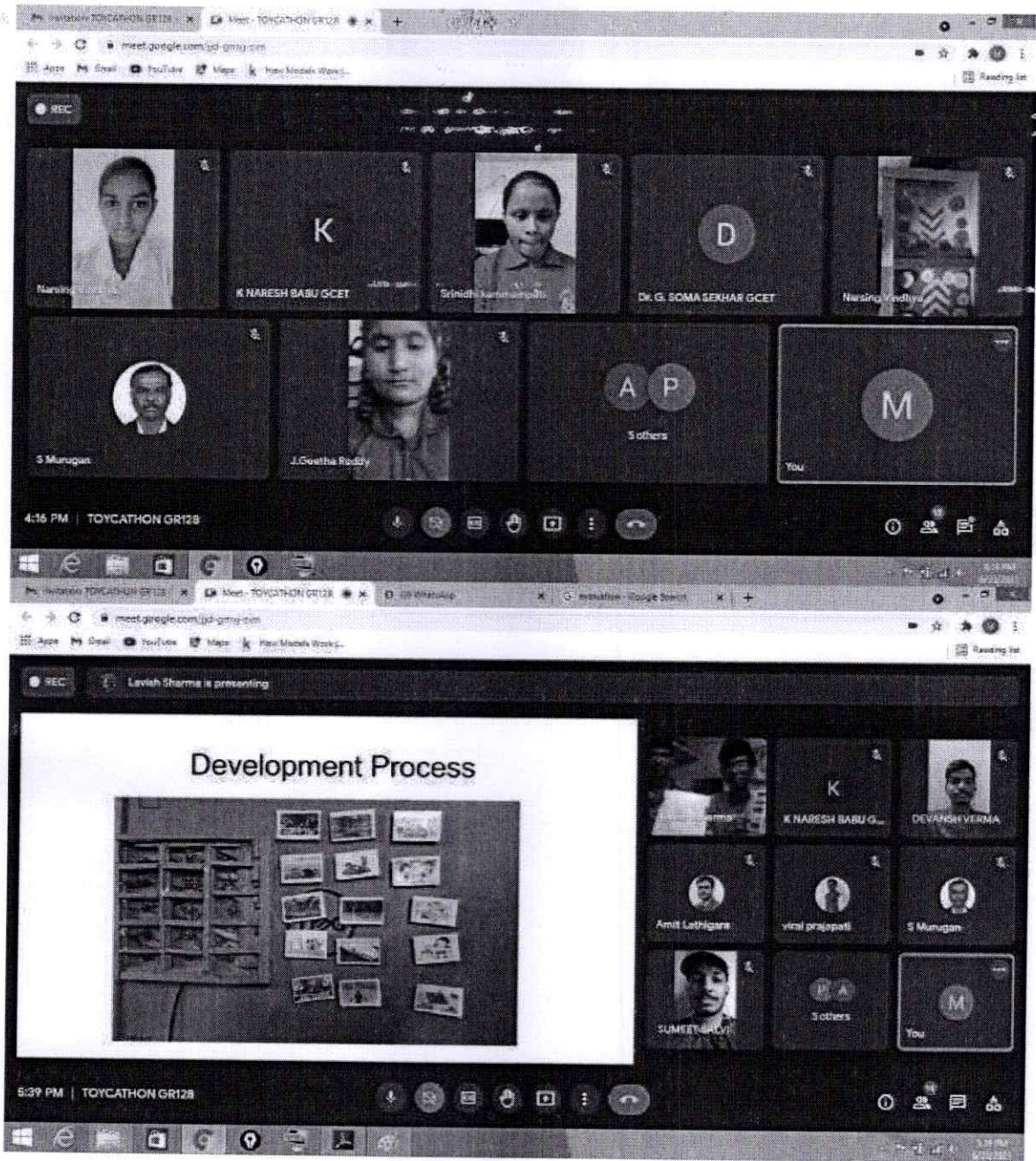

**PRINCIPAL**  
Geethanjali College of Engg. Tech.  
Cheerla (V), Keesara (M), R.R. Dist. (A.P.) - 501 301



## Addendum

The following teams submitted ideas to Toycathon from Geethanjali College of ENgg and Tech. after receiving mentoring and training sessions at the Incubation Center. However, there is no representation of GCET in the Toycathon as none of them could get shortlisted

Teams who submitted ideas to TOYCATHON						
Title	Names of the Team Members	Roll No.	Year of Study	Dept	Mentors	
Bharat Yatrik	A Sai Krupa, T Vishnu, B Abhishek	18R11A0550, 18R11A0592, 18R11A0554	3	CSE	Dr. SomaShekar Prof CSE	
Yatra Nritya	Pallavi	18R11A0243	3	EEE	Mr. Prashanth, Dr. Puppala Pr	
	Manikanta	19R11A0535	2	CSE		
	A.Uday	19R11A0301	2	MECH		
	P.Sumanth	18R11A0501	3	CSE		
	CH Akshitha	19R11A04FO	2	ECE		
	T.Vasavi sri lakshmi	19R11A04J9	2	ECE		
CROSS CARD GAME	N.KEVIN M.AFREEN MANASA NAGA	19R11A05M6 18R11A0581 18R11A0310 20R15A0238 19R11A0486			Dr. SomaShekar Prof CSE	
	Anchuri Harish kumar gupta	18R11A0364	3	MECH		
	K.Ashok Gajapathi Raju	18R11A05B7	3	CSE		
	M.Vamshi yuvaraj	20R15A0217	2	EEE		
	P.Abhishek	19R11A04H6	2	ECE		
	Tadem Manvitha	19R11A05D9	2	CSE		

## Appendix

1. Attendance sheets of the participants on 1<sup>st</sup> Day and 2<sup>nd</sup> Day
2. E-bookLet given to Jury
3. 3 Day schedule for the Hackathon
4. ToyCathon Roles and Responsibilites – as shared by AICTE

PRINCIPAL  
Geethanjali College of Engg. Tech.  
Cheeryal (V), Keesuru (M), K.R. Dist. (A.P.) - 501301

Attendance 22-6-21

S.No	Idea ID	Category	Team Name	Name	FN	AN	TL/TM
1	1219	Digital (L3)	The creators	Namah Vivek Puri	Present	Present	TL
			The creators	Megha Shyam Kardak	Present	Present	TM
			The creators	Snehal Sase	Present	Present	TM
2	11598	Digital	JAWAHAR NAVODAYA VIDYALAYA JHABUA -1			the team didn't show up	
			Peek n Find	Manya Gupta	Present	Present	TL
			Peek n Find	Swasti phalswal	Present	Present	TM
			Peek n Find	Satvik phalswal	Present	Present	TM
			Peek n Find	Mukund Gupta	Present	Present	TM
			Peek n Find	Atiksh gupta	Present	Present	TM
4	16506	Digital (L3)	Battle Of Empires	Sri Samskruthi Kokkonda	Present	Present	TL
			Battle Of Empires	Keerthi Sri Nallapaneni	Present	Present	TM
			Battle Of Empires	Sri Sahithi Kokkonda	Present	Present	TM
			Battle Of Empires	K. Deva Aashritha Joyce	Present	Present	TM
5	2079	Digital (L3)	NCSRNR	Latha Nittur	Present	Present	TL
				Deepti Vishwanath Loni	Present	Present	TM
				Chinmayi Ravi Kulkarni	Present	Present	TM
				Varshini V Sunagar	Present	Present	TM
				Chandana Gangadhar Naik	Present	Present	TM
				Rakesh Vishwaroop	Present	Present	TM
6	5558	Digital (L3)	Ayushmati	Sampa Das		not evaluated as it belongs to track 3	
7	17789	Digital (L3)	Sucpian	MOHAMMED UZAIR KHAN		not evaluated as it belongs to track 3	
8	13710	Digital	Sir issac Newton	Narsing Vindhya	Present	Present	TL
			Sir issac Newton	Kammampati Srinidhi	Present	Present	TM
			Sir issac Newton	Julakanti Geetha	Present	Present	TM
			Sir issac Newton	Didige Maruthi	Present	Present	TM
9	14924	Digital	Toystars	Lavish Sharma	ABSENT	Present	TL
			Toystars	Piyush Khunte	ABSENT	Present	TM
			Toystars	Devansh Verma	Present	ABSENT	TM
			Toystars	Sumeet Salvi	ABSENT	ABSENT	TM
10	11128	Digital (L3)	Hexa	Tvisha Pandey	Present	Present	TL
			Hexa	Jake Shaju	Present	Present	TM
			Hexa	Sivsurya MS	Present	Present	TM
			Hexa	Saurabh Singh Rajput	Present	Present	TM
			Hexa	Gargee Gain	Present	Present	TM
			Hexa	Pinakeen J Kolhe	Present	Present	TM
			Hexa	R. Solomon			Mentors
11	2079	Digital (L3)	vincible	M. shirley merlyn	Present	Present	TL
			vincible	Rhea Bandari	Present	Present	TM
			vincible	Pooja	Present	Present	TM
			vincible	Sharmila	Present	Present	TM
			vincible	Chaitanya	Present	Present	TM
12	3682	Digital (L3)	UTSUK	Tanvi shukla	Present	Present	TL
			UTSUK	Shailaja Solanki	Present	Present	TM
			UTSUK	Shivam Tripathi	Present	Present	TM
			UTSUK	Shushank Gautam	Present	Present	TM
			UTSUK	Surbhi Yadav	Present	Present	TM
			UTSUK	Tanu Jain	Present	Present	TM
			UTSUK	Hiraman Sikdar			Mentor
UTSUK	Vaishali Rao			Mentor			
13	12448	Digital	ToyX	Jitendra Shukla	Present	Present	TL
			ToyX	Supriya Anand	Present	Present	TM
			ToyX	Sahil Verma	Present	Present	TM
			ToyX	Aman Bilaiya	Present	Present	TM
			ToyX	Akshat Goel	Present	Present	TM
			ToyX	Dr. Neeraj Goel			Mentor
14	13480	Digital	MindBenders	Michelle Barbosa	Present	Present	TL
			MindBenders	Amit Mungare	Present	Present	TM
			MindBenders	Shreyas Rasaikar	Present	ABSENT	TM
			MindBenders	Razia Sardinha			Mentor

PRINCIPAL  
 Geethanjali College of Engg. Tech.  
 Cherepudi (V), Keeravani (M), R.R. Dist. (A.P.) 501 301



Email	Phone	Theme	Track	Evaluation Panel
imvivek@rediffmail.com	9868825690	Divyang	1	GR023
meghakardakapsb@rediffmail.com	8500339189	Divyang	1	GR023
snehalsasepsb@gmail.com	9381400976	Divyang	1	GR023
8052@sathyasaiindore.com	9111952502	Indian Culture, History, Knc	1	GR023
8322@sathyasaiindore.com	9425910909	Indian Culture, History, Knc	1	GR023
8321@SATHYASAIINDORE.COM	9582099356	Indian Culture, History, Knc	1	GR023
8721@SATHYASAIINDORE.COM	9425910909	Indian Culture, History, Knc	1	GR023
8051@SATHYASAIINDORE.COM	9582099356	Indian Culture, History, Knc	1	GR023
srisamskruthi.kokkonda@gmail.com	9100746926	Environment	1	GR023
ns_nallapaneni@yahoo.com	9246483736	Environment	1	GR023
srisahithi.kokkonda@gmail.com	8143817044	Environment	1	GR023
kattadevaashrithajoyce@gmail.com	8341910609	Environment	1	GR023
ncsrnr@gmail.com	9483657083	Learning, Education and Sc	1	GR023
deeptivloni24@gmail.com	8217319941	Learning, Education and Sc	1	GR023
crkchinmayi@gmail.com	9449145677	Learning, Education and Sc	1	GR023
varshinisunagar2006@gmail.com	6360824658	Learning, Education and Sc	1	GR023
chandananai2006@gmail.com	9448945740	Learning, Education and Sc	1	GR023
rakeshviswaroop51@gmail.com	8095692484	Learning, Education and Sc	1	GR023
	7406930133			
	9700194735			
narsingvindhya@gmail.com	8179236909	Social and human values	1	GR128
Pandusanthosha1985@gmail.com	9603014214	Social and human values	1	GR128
julakantjaiipalreddy79@gmail.com	9398402261	Social and human values	1	GR128
maruthididge@gmail.com	6300562699	Social and human values	1	GR128
lavish56sharma@gmail.com	8770029106	Environment	2	GR128
piyushkhunte093@gmail.com	9131153127	Environment	2	GR128
devanshvermame19@acropolis.in	8871090758	Environment	2	GR128
sumitsalvime19@acropolis.in	8871916298	Environment	2	GR128
tvisha.pandey2018@vitstudent.ac.in	9657803689	Environment	2	GR128
jakeshaju@gmail.com	88009 46292	Environment	2	GR128
sivasurya.ms@gmail.com	99807 11800	Environment	2	GR128
saurabh.singh2018b@vitstudent.ac.in	86300 23997	Environment	2	GR128
gaingargee0406@gmail.com	83710 41550	Environment	2	GR128
pinakeenkolhe2000@gmail.com.	96658 94151	Environment	2	GR128
solomon.r@vit.ac.in	9952963007	Environment	2	GR128
shirleymerlyn1210@gmail.com	9441342943	Indian Culture, History, Knc	2	GR128
rheabandari18@gmail.com	9603216419	Indian Culture, History, Knc	2	GR128
poojachelaka2002@gmail.com	8074003788	Indian Culture, History, Knc	2	GR128
sharmilamohammad98@gmail.com	9949017039	Indian Culture, History, Knc	2	GR128
chaitanyasumalakshmi@gmail.com	8519813778	Indian Culture, History, Knc	2	GR128
tanvishukla20482@acropolis.in	7440581138	Learning, Education and Sc	2	GR128
shailajasolanki20488@acropolis.in	7389350393	Learning, Education and Sc	2	GR128
shivamtripathi20607@acropolis.in	7509777633	Learning, Education and Sc	2	GR128
shushankgautam20714@acropolis.in	9131291160	Learning, Education and Sc	2	GR128
surbhiyadav20222@acropolis.in	8319982150	Learning, Education and Sc	2	GR128
tanujain20354@acropolis.in	7089092235	Learning, Education and Sc	2	GR128
hiramansikdar@acropolis.in	9405493834	Learning, Education and Sc	2	GR128
vaishalirao@acropolis.in	9407133020	Learning, Education and Sc	2	GR128
2018eeb1232@iitrpr.ac.in	8602943010	out of the box, creative and	2	GR128
2018eeb1185@iitrpr.ac.in	6204711884	out of the box, creative and	2	GR128
2018chb1057@iitrpr.ac.in	8921251840	out of the box, creative and	2	GR128
2018csb1069@iitrpr.ac.in	9521606386	out of the box, creative and	2	GR128
2018csb1067@iitrpr.ac.in	8441807651	out of the box, creative and	2	GR128
neeraj@iitrpr.ac.in	9818562842	out of the box, creative and	2	GR128
michellebarbosa789@gmail.com	7448048664	Social and human values	2	GR128
amungare27@gmail.com	78757 09937	Social and human values	2	GR128
ghosthunter0221@gmail.com	9370120157	Social and human values	2	GR128
	98606 74888	Social and human values	2	GR128

  
**PRINCIPAL**  
 Geethanjali COLLEGE  
 Cheeryal (V), Keeravani (M), K.R. Dist. (A.P.) - 501 301  
 Tech.  
 Cheeryal (V), Keeravani (M), K.R. Dist. (A.P.) - 501 301

college/school
Army public, School Bolaram
Army public, School Bolaram
Army public, School Bolaram
Sri sathya sai vidya vihar, indore
Sri sathya sai vidya vihar, indore
Sri sathya sai vidya vihar, indore
Sri sathya sai vidya vihar, indore
Sri sathya sai vidya vihar, indore
Skilledu VARSITY - HYDERABAD, TELANGANA
Skilledu VARSITY - HYDERABAD, TELANGANA
Skilledu VARSITY - HYDERABAD, TELANGANA
Skilledu VARSITY - HYDERABAD, TELANGANA
NITTUR CENTRAL SCHOOL
NITTUR CENTRAL SCHOOL
NITTUR CENTRAL SCHOOL
NITTUR CENTRAL SCHOOL
NITTUR CENTRAL SCHOOL
NITTUR CENTRAL SCHOOL
Jawahar Navodaya vidyalaya , Chalakurthy Cham
Jawahar Navodaya vidyalaya , Chalakurthy Cham
Jawahar Navodaya vidyalaya , Chalakurthy Cham
Jawahar Navodaya vidyalaya , Chalakurthy Cham
Acropolis Institute Of Technology and Research, I
Acropolis Institute Of Technology and Research, I
Acropolis Institute Of Technology and Research, I
Acropolis Institute Of Technology and Research, I
VIT University, Vellore - 632014, Tamil Nadu, INC
VIT University, Vellore - 632014, Tamil Nadu, INC
VIT University, Vellore - 632014, Tamil Nadu, INC
VIT University, Vellore - 632014, Tamil Nadu, INC
VIT University, Vellore - 632014, Tamil Nadu, INC
VIT University, Vellore - 632014, Tamil Nadu, INC
VIT University, Vellore - 632014, Tamil Nadu, INC
St. Pious X Degree and P.G. College for Women, N
St. Pious X Degree and P.G. College for Women, N
St. Pious X Degree and P.G. College for Women, N
St. Pious X Degree and P.G. College for Women, N
St. Pious X Degree and P.G. College for Women, N
Acropolis Institute of Technology and Research, I
Acropolis Institute of Technology and Research, I
Acropolis Institute of Technology and Research, I
Acropolis Institute of Technology and Research, I
Acropolis Institute of Technology and Research, I
Acropolis Institute of Technology and Research, I
Acropolis Institute of Technology and Research, I
Acropolis Institute of Technology and Research, I
IIT Ropar
IIT Ropar
IIT Ropar
IIT Ropar
IIT Ropar
IIT Ropar
Padre Conceicao College of Engineering, Goa
Padre Conceicao College of Engineering, Goa
Padre Conceicao College of Engineering, Goa
Padre Conceicao College of Engineering, Goa

  
**PRINCIPAL**  
 Geethanjali College of Engg. Tech.  
 Chervyl (V), Kaesara (M), R.R. Dist. (A.P.) - 501 30L



Toyathon GR128 Teams details

S.No	Idea ID	Category	Team Name	Name	Attendance 22-6-21 FN	TL/TM	Email
1	13710	Digital	Sir issac Newton	Narsing Vindhya	Present	TL	narsingvindhya@gmail.com
			Sir issac Newton	Kammampati Srinidhi	Present	TM	Pandusanthosha1985@gmail.com
			Sir issac Newton	Julakanti Geetha	Present	TM	julakantijaipalreddy79@gmail.com
			Sir issac Newton	Didige Maruthi	Present	TM	maruthididge@gmail.com
2	14924	Digital	Toystars	Lavish Sharma	ABSENT	TL	lavish56sharma@gmail.com
			Toystars	Piyush Khunte	ABSENT	TM	piyushkhunte093@gmail.com
			Toystars	Devansh Verma	Present	TM	devanshverma19@acropolis.in
			Toystars	Sumeet Salvi	ABSENT	TM	sumitsalvi19@acropolis.in
3	11128	Digital (L3)	Hexa	Tvisha Pandey	Present	TL	tvisha.pandey2018@vitstudent.ac.in
			Hexa	Jake Shaju	Present	TM	jakeshaju@gmail.com
			Hexa	Sivasurya MS	Present	TM	sivasurya.ms@gmail.com
			Hexa	Saurabh Singh Rajput	Present	TM	saurabh.singh2018b@vitstudent.ac.in
			Hexa	Gargee Gain	Present	TM	gaingargee0406@gmail.com
			Hexa	Pinakeen J Kolhe	Present	TM	pinakeenkolhe2000@gmail.com.
			Hexa	R. Solomon		Mentors	solomon.r@vit.ac.in
4	2079	Digital (L3)	vincible	M. shirley merlyn	Present	TL	shirleymerlyn1210@gmail.com
			vincible	Rhea Bandari	Present	TM	rheabandari18@gmail.com
			vincible	Pooja	Present	TM	poojachellaka2002@gmail.com
			vincible	Sharmila	Present	TM	sharmilamohammad98@gmail.com
			vincible	Chaitanya	Present	TM	chaitanyasumalakshmi@gmail.com
5	3682	Digital (L3)	UTSUK	Tanvi shukla	Present	TL	tanvishukla20482@acropolis.in
			UTSUK	Shailaja Solanki	Present	TM	shailajasolanki20488@acropolis.in
			UTSUK	Shivam Tripathi	Present	TM	shivamtripathi20607@acropolis.in
			UTSUK	Shushank Gautam	Present	TM	shushankgautam20714@acropolis.in
			UTSUK	Surbhi Yadav	Present	TM	surbhiyadav20222@acropolis.in
			UTSUK	Tanu Jain	Present	TM	tanujain20354@acropolis.in
			UTSUK	Hiraman Sikdar		Mentor	hiramansikdar@acropolis.in
			UTSUK	Vaishali Rao		Mentor	vaishalirao@acropolis.in
6	12448	Digital	ToyX	Jitendra Shukla	Present	TL	2018eeb1232@iitrpr.ac.in
			ToyX	Supriya Anand	Present	TM	2018eeb1185@iitrpr.ac.in
			ToyX	Sahil Verma	Present	TM	2018chb1057@iitrpr.ac.in
			ToyX	Aman Bilaiya	Present	TM	2018csb1069@iitrpr.ac.in
			ToyX	Akshat Goel	Present	TM	2018csb1067@iitrpr.ac.in
			ToyX	Dr. Neeraj Goel		Mentor	neeraj@iitrpr.ac.in
7	13480	Digital	MindBenders	Michelle Barbosa	Present	TL	michellebarbosa789@gmail.com
			MindBenders	Amit Mungare	Present	TM	amungare27@gmail.com
			MindBenders	Shreyas Rasaikar	Present	TM	ghosthunter0221@gmail.com
			MindBenders	Razia Sardinha		Mentor	

**PRINCIPAL**  
 Geethanjali College of Engg. Tech.  
 Cheerpal (V), Keerasuru (M), R.R. Dist. (A.P.) - 501 301

22-6-2021

Phone	Theme	Track	Evaluation Panel
8179236909	Social and human values	1	GR128
9603014214	Social and human values	1	GR128
9398402261	Social and human values	1	GR128
6300562699	Social and human values	1	GR128
8770029106	Environment	2	GR128
9131153127	Environment	2	GR128
8871090758	Environment	2	GR128
8871916298	Environment	2	GR128
9657803689	Environment	2	GR128
88009 46292	Environment	2	GR128
99807 11800	Environment	2	GR128
86300 23997	Environment	2	GR128
83710 41550	Environment	2	GR128
96658 94151	Environment	2	GR128
9952963007	Environment	2	GR128
9441342943	indian Culture, History, Know	2	GR128
9603216419	indian Culture, History, Know	2	GR128
8074003788	indian Culture, History, Know	2	GR128
9949017039	indian Culture, History, Know	2	GR128
8519813778	indian Culture, History, Know	2	GR128
7440581138	Learning, Education and Sch	2	GR128
7389350393	Learning, Education and Sch	2	GR128
7509777633	Learning, Education and Sch	2	GR128
9131291160	Learning, Education and Sch	2	GR128
8319982150	Learning, Education and Sch	2	GR128
7089092235	Learning, Education and Sch	2	GR128
9405493834	Learning, Education and Sch	2	GR128
9407133020	Learning, Education and Sch	2	GR128
8602943010	out of the box, creative and	2	GR128
6204711884	out of the box, creative and	2	GR128
8921251840	out of the box, creative and	2	GR128
9521606386	out of the box, creative and	2	GR128
8441807651	out of the box, creative and	2	GR128
9818562842	out of the box, creative and	2	GR128
7448048664	Social and human values	2	GR128
78757 09937	Social and human values	2	GR128
9370120157	Social and human values	2	GR128
98606 74888	Social and human values	2	GR128

PRINCIPAL  
 Geethanjali College of Engg. Tech.  
 Choeryal (V), Keesara (M), R.R. Dist. (A.R.) - 501 306.



college/school
Jawahar Navodaya vidyalaya , Chalakurthy Champ , Nalgonda.
Jawahar Navodaya vidyalaya , Chalakurthy Champ , Nalgonda.
Jawahar Navodaya vidyalaya , Chalakurthy Champ , Nalgonda.
Jawahar Navodaya vidyalaya , Chalakurthy Champ , Nalgonda.
Acropolis Institute Of Technology and Research,Indore.MP
Acropolis Institute Of Technology and Research,Indore.MP
Acropolis Institute Of Technology and Research,Indore.MP
Acropolis Institute Of Technology and Research,Indore.MP
VIT University, Vellore - 632014, Tamil Nadu, INDIA.
VIT University, Vellore - 632014, Tamil Nadu, INDIA.
VIT University, Vellore - 632014, Tamil Nadu, INDIA.
VIT University, Vellore - 632014, Tamil Nadu, INDIA.
VIT University, Vellore - 632014, Tamil Nadu, INDIA.
VIT University, Vellore - 632014, Tamil Nadu, INDIA.
VIT University, Vellore - 632014, Tamil Nadu, INDIA.
St. Pious X Degree and P.G. College for Women,Nacharam, Hyderabad, Telangana
St. Pious X Degree and P.G. College for Women,Nacharam, Hyderabad, Telangana
St. Pious X Degree and P.G. College for Women,Nacharam, Hyderabad, Telangana
St. Pious X Degree and P.G. College for Women,Nacharam, Hyderabad, Telangana
St. Pious X Degree and P.G. College for Women,Nacharam, Hyderabad, Telangana
Acropolis Institute of Technology and Research, Indore, M.P.
Acropolis Institute of Technology and Research, Indore, M.P.
Acropolis Institute of Technology and Research, Indore, M.P.
Acropolis Institute of Technology and Research, Indore, M.P.
Acropolis Institute of Technology and Research, Indore, M.P.
Acropolis Institute of Technology and Research, Indore, M.P.
Acropolis Institute of Technology and Research, Indore, M.P.
Acropolis Institute of Technology and Research, Indore, M.P.
IIT Ropar
IIT Ropar
IIT Ropar
IIT Ropar
IIT Ropar
IIT Ropar
Padre Conceicao College of Engineering, Goa
Padre Conceicao College of Engineering, Goa
Padre Conceicao College of Engineering, Goa
Padre Conceicao College of Engineering, Goa

  
**PRINCIPAL**  
 Geethanjali College of Engg. Tech.  
 Cheeral (V), Keesara (M), R.R. Dist. (A.P.) - 501 301

Toycathon GR128 Teams details

Attendance 22-6-21

S.No	Idea ID	Category	Team Name	Name	FN	AN	TL/TM
1	13710	Digital	Sir issac Newton	Narsing Vindhya	Present	Present	TL
			Sir issac Newton	Kammampati Srinidhi	Present	Present	TM
			Sir issac Newton	Julakanti Geetha	Present	Present	TM
			Sir issac Newton	Didige Maruthi	Present	Present	TM
2	14924	Digital	Toystars	Lavish Sharma	ABSENT	Present	TL
			Toystars	Piyush Khunte	ABSENT	Present	TM
			Toystars	Devansh Verma	Present	ABSENT	TM
			Toystars	Sumeet Salvi	ABSENT	ABSENT	TM
3	11128	Digital (L3)	Hexa	Tvisha Pandey	Present	Present	TL
			Hexa	Jake Shaju	Present	Present	TM
			Hexa	Sivsurya MS	Present	Present	TM
			Hexa	Saurabh Singh Rajput	Present	Present	TM
			Hexa	Gargee Gain	Present	Present	TM
			Hexa	Pinakeen J Kolhe	Present	Present	TM
			Hexa	R. Solomon			Mentors
4	2079	Digital (L3)	vincible	M. shirley merlyn	Present	Present	TL
			vincible	Rhea Bandari	Present	Present	TM
			vincible	Pooja	Present	Present	TM
			vincible	Sharmila	Present	Present	TM
			vincible	Chaitanya	Present	Present	TM
5	3682	Digital (L3)	UTSUK	Tanvi shukla	Present	Present	TL
			UTSUK	Shailaja Solanki	Present	Present	TM
			UTSUK	Shivam Tripathi	Present	Present	TM
			UTSUK	Shushank Gautam	Present	Present	TM
			UTSUK	Surbhi Yadav	Present	Present	TM
			UTSUK	Tanu Jain	Present	Present	TM
			UTSUK	Hiraman Sikdar			Mentor
			UTSUK	Vaishali Rao			Mentor
6	12448	Digital	ToyX	Jitendra Shukla	Present	Present	TL
			ToyX	Supriya Anand	Present	Present	TM
			ToyX	Sahil Verma	Present	Present	TM
			ToyX	Aman Bilaiya	Present	Present	TM
			ToyX	Akshat Goel	Present	Present	TM
			ToyX	Dr. Neeraj Goel			Mentor
7	13480	Digital	MindBenders	Michelle Barbosa	Present	Present	TL
			MindBenders	Amit Mungare	Present	Present	TM
			MindBenders	Shreyas Rasaikar	Present	ABSENT	TM
			MindBenders	Razia Sardinha			Mentor

  
**PRINCIPAL**  
 Geethanjali College of Engg. Tech.  
 Cheeryal (V), Keesara (M), R.R. Dist. (A.P.) - 501 301



22-6-2021

Email	Phone	Theme	Track	Evaluation Panel
narsingvindhya@gmail.com	8179236909	Social and human values	1	GR128
Pandusanthosha1985@gmail.com	9603014214	Social and human values	1	GR128
julakantijaipalreddy79@gmail.com	9398402261	Social and human values	1	GR128
maruthididge@gmail.com	6300562699	Social and human values	1	GR128
lavish56sharma@gmail.com	8770029106	Environment	2	GR128
piyushkhunte093@gmail.com	9131153127	Environment	2	GR128
devanshvername19@acropolis.in	8871090758	Environment	2	GR128
sumitsalvime19@acropolis.in	8871916298	Environment	2	GR128
tvisha.pandey2018@vitstudent.ac.in	9657803689	Environment	2	GR128
jakeshaju@gmail.com	88009 46292	Environment	2	GR128
sivasurya.ms@gmail.com	99807 11800	Environment	2	GR128
saurabh.singh2018b@vitstudent.ac.in	86300 23997	Environment	2	GR128
gaingargee0406@gmail.com	83710 41550	Environment	2	GR128
pinakeenkolhe2000@gmail.com	96658 94151	Environment	2	GR128
solomon.r@vit.ac.in	9952963007	Environment	2	GR128
shirleymerlyn1210@gmail.com	9441342943	indian Culture, History, Know	2	GR128
rheabandari18@gmail.com	9603216419	indian Culture, History, Know	2	GR128
poojachelaka2002@gmail.com	8074003788	indian Culture, History, Know	2	GR128
sharmilamohammad98@gmail.com	9949017039	indian Culture, History, Know	2	GR128
chaitanyasumalakshmi@gmail.com	8519813778	indian Culture, History, Know	2	GR128
tanvishukla20482@acropolis.in	7440581138	Learning, Education and Sch	2	GR128
shailajasolanki20488@acropolis.in	7389350393	Learning, Education and Sch	2	GR128
shivamtripathi20607@acropolis.in	7509777633	Learning, Education and Sch	2	GR128
shushankgautam20714@acropolis.in	9131291160	Learning, Education and Sch	2	GR128
surbhiyadav20222@acropolis.in	8319982150	Learning, Education and Sch	2	GR128
tanujain20354@acropolis.in	7089092235	Learning, Education and Sch	2	GR128
hiramansikdar@acropolis.in	9405493834	Learning, Education and Sch	2	GR128
vaishalirao@acropolis.in	9407133020	Learning, Education and Sch	2	GR128
2018eeb1232@iitrpr.ac.in	8602943010	out of the box, creative and	2	GR128
2018eeb1185@iitrpr.ac.in	6204711884	out of the box, creative and	2	GR128
2018chb1057@iitrpr.ac.in	8921251840	out of the box, creative and	2	GR128
2018csb1069@iitrpr.ac.in	9521606386	out of the box, creative and	2	GR128
2018csb1067@iitrpr.ac.in	8441807651	out of the box, creative and	2	GR128
neeraj@iitrpr.ac.in	9818562842	out of the box, creative and	2	GR128
michellebarbosa789@gmail.com	7448048664	Social and human values	2	GR128
amungare27@gmail.com	78757 09937	Social and human values	2	GR128
ghosthunter0221@gmail.com	9370120157	Social and human values	2	GR128
	98606 74888	Social and human values	2	GR128

PRINCIPAL  
 Geethanjali College of Engg. Tech.  
 Cheeryal (V), Keasara (M), R.R. Dist. (A.P.) - 501 301.

college/school
Jawahar Navodaya vidyalaya , Chalakurthy Champ , Nalgonda.
Jawahar Navodaya vidyalaya , Chalakurthy Champ , Nalgonda.
Jawahar Navodaya vidyalaya , Chalakurthy Champ , Nalgonda.
Jawahar Navodaya vidyalaya , Chalakurthy Champ , Nalgonda.
Acropolis Institute Of Technology and Research,Indore.MP
Acropolis Institute Of Technology and Research,Indore.MP
Acropolis Institute Of Technology and Research,Indore.MP
Acropolis Institute Of Technology and Research,Indore.MP
VIT University, Vellore - 632014, Tamil Nadu, INDIA.
VIT University, Vellore - 632014, Tamil Nadu, INDIA.
VIT University, Vellore - 632014, Tamil Nadu, INDIA.
VIT University, Vellore - 632014, Tamil Nadu, INDIA.
VIT University, Vellore - 632014, Tamil Nadu, INDIA.
VIT University, Vellore - 632014, Tamil Nadu, INDIA.
VIT University, Vellore - 632014, Tamil Nadu, INDIA.
St. Pious X Degree and P.G. College for Women,Nacharam, Hyderabad
St. Pious X Degree and P.G. College for Women,Nacharam, Hyderabad
St. Pious X Degree and P.G. College for Women,Nacharam, Hyderabad
St. Pious X Degree and P.G. College for Women,Nacharam, Hyderabad
St. Pious X Degree and P.G. College for Women,Nacharam, Hyderabad
Acropolis Institute of Technology and Research, Indore, M.P.
Acropolis Institute of Technology and Research, Indore, M.P.
Acropolis Institute of Technology and Research, Indore, M.P.
Acropolis Institute of Technology and Research, Indore, M.P.
Acropolis Institute of Technology and Research, Indore, M.P.
Acropolis Institute of Technology and Research, Indore, M.P.
Acropolis Institute of Technology and Research, Indore, M.P.
Acropolis Institute of Technology and Research, Indore, M.P.
Acropolis Institute of Technology and Research, Indore, M.P.
IIT Ropar
IIT Ropar
IIT Ropar
IIT Ropar
IIT Ropar
IIT Ropar
Padre Conceicao College of Engineering, Goa
Padre Conceicao College of Engineering, Goa
Padre Conceicao College of Engineering, Goa
Padre Conceicao College of Engineering, Goa

**PRINCIPAL**  
 Geethanjali College of Engg. Techn.  
 Cheeryal (V), Keesuru (M), R.R. Dist. (A.P.) - 501 301



Idea ID	Category	Team Name	TL
1219	Digital (L3)	The creators	NAMAH VIVEK PURI
11598	Digital	JAWAHAR NA	SOUMYARAJ SINGH VASKEL
11798	Digital	Peek n Find	Maanya Gupta
16506	Digital	Battle of Empir	Sri Samskruthi Kokkonda
5349	Digital (L3)	NCSRNR team	LATHA NITTUR
5558	Digital (L3)	Aayushmati	Sampa Das
17789	Digital (L3)	Sucpian	MOHAMMED UZAIR KHAN
13710	Digital	Sir issac Newt	Narsing Vindhya
14924	Digital	Toystars	Lavish Sharma
11128	Digital (L3)	Hexa	Tvisha Pandey
2079	Digital (L3)	vincible	M. shirley merlyn
3682	Digital (L3)	UTSUK	Tanvi shukla
12448	Digital	ToyX	Jitendra Shukla
13480	Digital	MindBenders	Michelle Barbosa

  
**PRINCIPAL**  
 Geethanjali College of Engg. Techn.  
 Cheeryal (V), Keesara (M), R.R. Dist. (A.P.) - 501 30L

**E-Booklet - Given to Jury, Participants and Coordinator**

Theme/Track	Evaluation	
		Panel
Divyang	1	GR023
indian Culture, History, Knowledge of India and Ethos	1	GR023
indian Culture, History, Knowledge of India and Ethos	1	GR023
indian Culture, History, Knowledge of India and Ethos	1	GR023
Learning, Education and Schooling	1	GR023
Learning, Education and Schooling	1	GR023
Learning, Education and Schooling	1	GR023
Social and human values	1	GR128
Environment	2	GR128
Environment	2	GR128
indian Culture, History, Knowledge of India and Ethos	2	GR128
Learning, Education and Schooling	2	GR128
out of the box, creative and logical thinking	2	GR128
Social and human values	2	GR128

  
**PRINCIPAL**  
 Geethanjali College of Engg. Tech.  
 Cheeryal (V), Keesara (M), R.R. Dist. (A.P.) - 501 301



Time Slots	
Mentoring	Evaluation
11-00 a.m. to 11-15a.m Day-1,2	4.00p.m. to 4-15-p.m-Day-1,2
11-15a.m. to 11-30a.m Day-1,2	4.15p.m. to 4-30-p.m-Day-1,2
11-30a.m. to 11-45a.m Day-1,2	4.30p.m. to 4-45-p.m-Day-1,2
11-45a.m. to 12-00p.m Day-1,2	4.45p.m. to 5-00-p.m-Day-1,2
12-00p.m. to 12-15p.m Day-1,2	5-00p.m. to 5-15-p.m-Day-1,2
12-15p.m. to 12-30p.m Day-1,2	5-15p.m. to 5-30-p.m-Day-1,2
12-30p.m. to 12-45p.m Day-1,2	5-30p.m. to 5-45-p.m-Day-1,2
11-00 a.m. to 11-15a.m Day-1,2	4.00p.m. to 4-15-p.m-Day-1,2
12-30p.m. to 12-45p.m Day-1,2	5-30p.m. to 5-45-p.m-Day-1,2
11-15a.m. to 11-30a.m Day-1,2	4.15p.m. to 4-30-p.m-Day-1,2
11-30a.m. to 11-45a.m Day-1,2	4.30p.m. to 4-45-p.m-Day-1,2
11-45a.m. to 12-00p.m Day-1,2	4.45p.m. to 5-00-p.m-Day-1,2
12-00p.m. to 12-15p.m Day-1,2	5-00p.m. to 5-15-p.m-Day-1,2
12-15p.m. to 12-30p.m Day-1,2	5-15p.m. to 5-30-p.m-Day-1,2

  
**PRINCIPAL**  
 Geethanjali College of Engg. Tech.  
 Cheeryal (V), Keesara (M), R.R. Dist. (A.P.) - 501 301.

Name of the Coordinator to which this task is assigned			
Coordinator 1 Ensures timing is maintained and invites the students	Coordinator 2, Attendance, ID, ensures recording	Coordinator 3	
Mr. C. Vikas	Mr. Gowtham	Mr. Y Anil	
K. Naresh Babu	Mr. Sandeep	Mr. Anand	

  
**PRINCIPAL**  
 Goethan, ali College of Engg. Tech.  
 Cheeryal (V), Kousara (M), K.R. Dist. (A.P.) - 501 301



## SCHEDULE

### TOYCATHON 2021 DIGITAL EDITION 22<sup>nd</sup>, 23<sup>rd</sup>, 24<sup>th</sup> June 2021

<b>Tuesday, 22<sup>nd</sup> June 2021</b>	<b>DAY 1</b>
8:00 AM – 8:45 AM	<b>Local Inauguration by Nodal Center</b> <i>Inauguration of 'Grand Finale of Toycathon-2021' at Institute level</i> Welcome Address by Chairman / President of the Institute. Speech by Guest of Honor at NC Speech by Chief Guest at NC,
9:00 AM to 10:00 AM	<b>National Inauguration</b> Address by Hon'ble Ministers, AICTE Officials and Representatives of Ministries., Detailed M2M to be shared. <b>Inauguration Ends</b>
10:00 AM	Toycathon-2021 Begins
11:00 AM – 1:00 AM PM	First Round of Mentoring Session. (5-10 minutes per team)
<b>1:00 PM – 1:45 PM</b>	<b>Lunch Break</b>
1:45 PM onwards	Coding / Toy Building continues
4:00 PM to 6:00 PM	First Round of Evaluation
<b>Wednesday, 23<sup>rd</sup> June 2021</b>	<b>Day 2</b>
8:30 AM onwards	Coding / Toy Building continues
11:00 AM - 1:00 PM	Second Round of Mentoring Session. (7-10 minutes per team)
<b>1:00 PM to 1:45 PM</b>	<b>Lunch Break</b>
1:45 PM onwards	Coding / Toy Building continues

**PRINCIPAL**  
Geethanjali College of Engg. Tech.  
Cheerai (V), Kaesala (M), R.R. Dist. (A.P.) - 501 301.

4:00 PM - 6:00 PM	Second Round of Evaluation
-------------------	----------------------------

<b>Thursday, 24<sup>th</sup> June 2021</b>	<b>Day 3</b>
8:30 AM onwards	Coding / Toy Building continues
9:30 AM – 10:50 AM	Third Round of Mentoring Session (Last & Final Round of mentoring)
<b>11:00 AM- 12:15 PM</b>	<b>Address of Hon'ble PM and Interaction with student teams</b>
12:15 PM – 1:00 PM	Coding continues
<b>1:00 PM to 1:45 PM</b>	<b>Lunch Break</b>
1:45 PM onwards	Coding / Toy Building continues
<b>4.00 PM</b>	<b>Coding / Toy Building Stops</b>
4.00 PM – 6:00 PM	Third Round of Evaluation (Last & Final Round of evaluation)
6:00 PM to 7:00 PM	Submission of results by panelists

<b>26<sup>th</sup> June, Saturday</b>	<b>Day 4 Results Announcement</b>
---------------------------------------	-----------------------------------

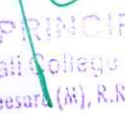
  
**PRINCIPAL**  
 Geethanjali College of Engg. Tech.  
 Cheeryal (V), Keesara (M), R.R. Dist. (A.P.) - 501 301.



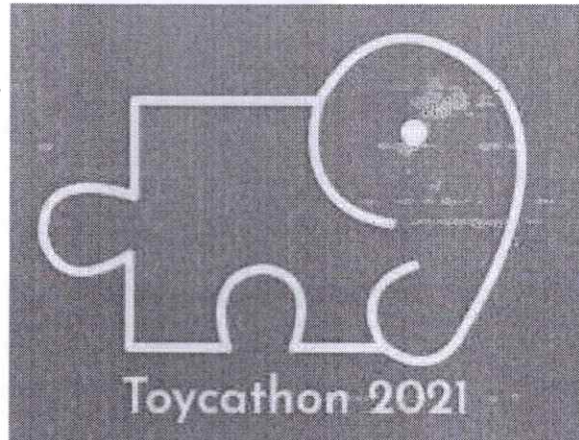

# Roles and Responsibilities of a Nodal Center for hosting Toycathon 2021







A Guidebook to host a Toycathon

## Participating Ministries

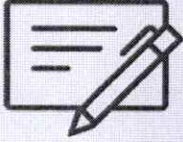

PRINCIPAL  
Gauthamali College of Engg. Tech.  
Cheerol (V), Aasara (M), R.K. Dist. (A.K.) - 501 301

This document aims at helping Nodal Centers prepare themselves up for hosting Toycathon 2021. Following are the Brief heads and below is the document explaining each head in detail.

1		Registration
2		Hosting Space and Requirements for TOYCATHON
3		IT
4		Food
5		Staff
6		Accommodation Requirement
7		DOs and DON'Ts

  
**PRINCIPAL**  
Geethanjali College of Engg. Tech.  
Cheerpal (V), Keesara (M), R.R. Dist. (A.P.) - 501 301



1

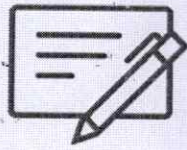

## Registration

### What do you need to register students and their mentors?

Registration Kit: The kit would be given to each individual Participant. It should have all of the following within it:

- a. Stationary: Chart Sheets with the branding of TOYCATHON 2021 and the nodal institute
- b. Lodging rooms Assistant: An assistant's number and a chart explaining their residence facility. Also, someone at kiosk noting down the place where each student would be put up
- c. Food Coupons: Coupons for each individual meal that would be served during the span of 3-5 days. Can include coupons for snacks and refreshments as well
- d. Lanyards: I-D card and lanyards for all participants. Sample badges are provided in the repository.
- e. Venue Map- A map of the venue
- f. Standee/T-Shirt Requirement: Each Team will bring their own T-Shirts with them (TOYCATHON 2021 logo on the left side is mandatory). They also need to bring a Standee/ banner showing their college detail and team name.

Registration form: Each nodal center will share the electronic copy of the teams' registration which should include the team name, id align with the team members' names, mobile, and email id.

Wi-Fi Password: Name and Password of Wi-Fi they need to connect to. This could be common amongst a team of 6-8 members

College Letter/College ID check: It would be mandatory for the Registration desk to check the Entry ticket received by the team, College IDs for each

PRINCIPAL  
 Goethanjali College of Engg. Tech.  
 Cherappal (V), Kozhikode (K), S.K. Dist. (A.I.) - 591 391

individual, and a letter from the college allowing participation.

**Covid-Vaccine Certification checks:** It is mandatory for the Registration desk to check the vaccine certification of all the participants (All Age Groups above 18).

**Travel Allowance/Reimbursement Desk (only for Distant Participants):** A desk that checks train/bus tickets, accepts the Travel Allowance forms from the team leader, and takes down details of the online transaction of money into the team leaders' account.

**Physical copies:** The Nodal center to keep copies of

- g. A Valid Government ID per individual
- h. A valid College ID per individual
- i. A TA form per Team
- j. A college letter allowing participation
- k. Copy of Travel Tickets
- l. Vaccine Certificate

**A Student Booklet:** Containing all of the following details

- a. IT Coordinators contact nos.
- b. Food Coordinator contact nos.
- c. Accommodation Coordinator contact nos. (1 man, 1 Woman)

**Registration of Judges:**

- Please note the details of judges on a Form.
- Evaluation Kit: The kit which will include guidelines, scoring sheets that would help judges evaluate ideas
- Judge registration kit: A kit provided to judges for a better understanding of the entire schedule:
  - a. Judge Badge
  - b. Please provide them a list of all teams with their solution details
  - c. Thank you letter from the Nodal Center for each judge.

PRINCIPAL  
Geethanjali College of Engg. Tech.  
Cheyral (V), Kozhikode (K), S.R. Dist. (K.A.) - 501 301



2

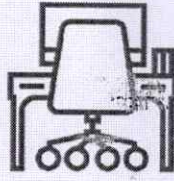

## Hosting Space and Requirements for TOYCATHON 2021

### How Should your Work Area be Managed? What are the requirements for hosting the Toycathon 2021

How should your work area be managed? What are the requirements for hosting the Toycathon 2021

- Big Hall: The Nodal Centers need to have two to three Hall large enough to host all the teams maintaining the social distancing.
- Seating Arrangement: The Nodal Center needs to build Seating arrangement for approximately 200 people at maximum includes students, mentors, judges, organizing staff etc. maintain social distancing. (The total number of people can be minimized as per the Covid-19 circumstanced at the time of Hackathon conduct).
- Machinery/Tools: Equipment such as Electronic Prototyping Components, Casting materials, Programming Boards, Hard Prototyping Materials, Soft Prototyping Materials, 3D printer, Soldering Station, Laser Cutter (acrylic), Milling Machine, Hand & Power Tools CNC Machine, Bolt Threading Machine, Lathe Shaping Machine, Wood Working Machinery, General Plastic Working Machinery.
- Work Tables: Seating/work spaces for teams can be arranged in the following manner.

Ideal table size would be 6ft\* 4ft in size

PRINCIPAL  
Geethanjali College of Engg. Tech.  
Cheerayal (V), Keesara (M), R.R. Dist. (A.P.) - 501 307.

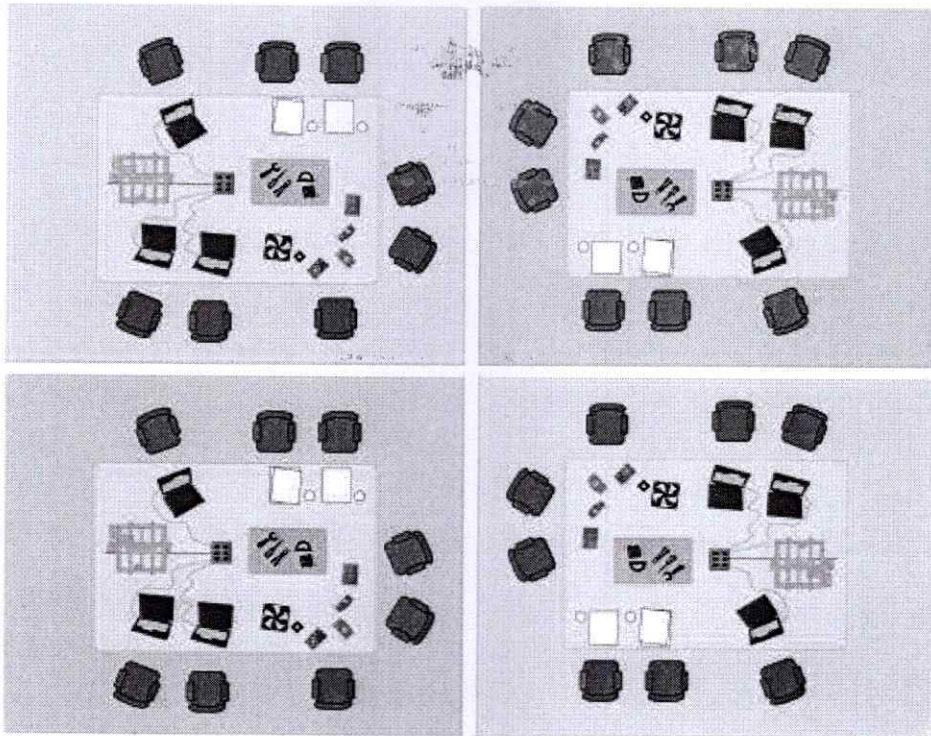

- 9 Chairs per team, on each table. 6 team members, 2 mentors, 1 judge. Each Chair should be rotatable, should allow height adjustment, Good Foam seating, and back. Nodal Centers need to help these candidates achieve comfort during the entire hackathon duration.
- 10 Plug Points Per Work Table (8 Laptops, 2 Mobile Charging Points, 2 Electronic Device Testing points)
- Emergency multi-plug: 3 pins or Extension boards, in case of shutdown of specific plugs
- PCs: If there is a need for providing PCs to certain students
- Dustbins: One mid-size dustbin amongst a set of 3-4 teams (Total 12-15)
- Beanbags: For Relaxing of Candidates, to take some time off. These could be per team, or a separate slot where relaxing is allowed
- Mattresses: Participants can relax or take a power nap for short periods of time. A separate place for men and women.
- Projector: To project all forms of Video speeches and sessions done by officials during the entire program
- Speakers: One Set of Speakers
- MIC: For video conferencing facility with Organizers
- Video-conferencing Facility: Pre Tested Video Conferencing Facility/

PRINCIPAL  
 Geethanjali College of Engg. Tech.  
 (Boyal V), Keosala (M), R.R. Dist. (A.P.) - 501 307



Webcasting Facility. This will be required in a central location especially for the opening ceremony; closing ceremony and any other Live sessions that may be organized during the course of the hackathon. NIC will be getting in touch with the respective nodal centers for setting up the video conferencing system.

- Power Backup: UPS might not be Sufficient, Nodal Centers need to have a standby DG
- Transport for Participants (only for Distant participants): Local transport to ferry the arriving students from railway station/ bus stand to your institute when they arrive for the hackathon and back to the railway station/ bus stand when they depart post the event. You may also arrange for inter-institute transport for students to shuttle between the lodging areas and the main hackathon bay area by taking into consideration the distances within the campus
- Transportation for Judges: Transportation needs to be provided for the judges arriving at the venue.
- Accommodation Facilities (only for distant participants): Accommodation Facility for students and judges. Boys and Girls to have separate hostels.
- Special Local Transport for Females: Females traveling post-sunset need to be provided a special transport along with a lady security guard.
- Special Location to address the Press: The Nodal Center should have a separate room to address the press.
- A Medical Kit: A First aid Kit for any unprecedented events
- Fire Extinguishers: A Set of at least 2 fire extinguishers
- Separate washrooms for men and women, toiletries to run for 4 cleaning cycles, 1 toilet amongst 10 students max.
- Water Coolers & water kegs with chilled and hot water facilities. 1 keg for every 2 teams. Regular changing of water kegs with filled kegs.
- Special water bottles for Judges.
- Coffee Machines
- Music System: A music system with proper sound quality
- Mementoes and Certificates for Judges/Mentors/ Special Guests

  
**PRINCIPAL**  
 Goethanjali College of Engg. Tech.  
 Chennai (V), Keesara (M), R.R. Dist. (A.P.) - 501 301

3

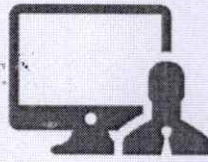

## IT Requirement

### Technological Requirement at Nodal Centers

- One Wired Internet Connection: A connection which is wired that can be extended
- 2 lines of 100MBPS each: 2 lease lines of 100 MBPS each.
- Strong firewall for protecting the entire site from outside world hacking.
- Video Conferencing Facility: A facility that helps nodal center coordinator to do video conferencing
- Projection Screen: A Place Projection could be made visible to all the audience.
- Machinery/Tools: Equipment such as Electronic Prototyping Components, Casting materials, Programming Boards, Hard Prototyping Materials, Soft Prototyping Materials, 3D printer, Soldering Station, Laser Cutter (acrylic), Milling Machine, Hand & Power Tools CNC Machine, Bolt Threading Machine, Lathe Shaping Machine, Wood Working Machinery, General Plastic Working Machinery.

PRINCIPAL  
Geethanjali College of Engg. Tech.  
Cheerla (V), Keesara (M), R.R. Dist. (A.P.) - 501 301



4

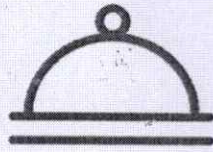

Food

## Food Requirement at Nodal Centers

- Seating Arrangement with social distancing for all participants and guests at a time. Should be a shaded region.
- Food Arrangements for 4 meals a day for 3-5days.
- Snacks Packets: Biscuits, Local Snacks Availability
- Non-Oily Dinner to help people stay awake at night
- Tea/ Coffee/ Biscuits/ any bakery item to be available round the clock for all participants.
- Availability of paid 24x7 counter for food availability, if required.
- Breakfast, Lunch, Dinner to be provided only on the basis of food coupons.
- Participants are expected to take care of the cleanliness of the place.

  
PRINCIPAL  
Geethanjali College of Engg. Tech.  
Cheeryal (V), Keesara (M), R.R. Dist. (A.P.) - 501301

5



Staff

## Human Resources required at Nodal Centers

### Human Resources required at Nodal Centers

- SPOC for Accommodation Arrangement for students
- 2 x IT coordinators for managing IT problems
- 4 x Wi-Fi Coordinators for managing Wi-Fi Related problems
- 4 x Lab Coordinators/Machine operators for managing machinery/tools.
- Campus Staff at Registration Desk
- Volunteers for Crowd Control
- 1 timekeeper for all activities/ A big watch at the venue will help
- SPOC for all Judges/Mentors
- Security personnel
- SPOC for Press
- House-keeping staff to maintain cleanliness on the floor, washrooms etc.
- Lady Security personnel for women safety on floor and travel outside.
- On Call Emergency Doctor
- Food organizers, waiters etc.
- Operators / Helpers for machines (on need basis!)
- 2 – 4 Product Designers, industry experts with knowledge of beautifying products to guide students during 5 days of the hackathon(numbers would depend on the teams hosted at your centre)
- 2 – 4 Hardware experts – to guide students during the 5 days of the hackathon
- Jury for 3 days of hackathon – can be professors with relevant expertise as per the theme / company / ministry hosted at the center

PRINCIPAL  
 Geethanjali College of Engg. Tech.  
 Cheeryal (V), Keesara (M), R.R. Dist. (A.P.) - 501 301



6



## Accommodation Requirement

How should the accommodation facility be provided to students and judges?

- Accommodation facilities (only for distant participants):  
Accommodation facilities for students, mentors, and judges. Boys and Girls to have separate hostels (maintaining social distancing).
- Accommodation will be required for the teams coming from a longer distance and most of the teams will be assigned from local proximity i.e. nearby to the nodal centers which will not be requiring any accommodation.

PRINCIPAL  
Geethanjali College of Engg. Tech.  
Cheeryal (V), Keesara (M), K.R. Dist. (A.P.) - 501 301

7



## DOs and DON'Ts

### DOs For the Nodal Center

- Follow and strictly adhere to all COVID-19 Protocol and behavior. The Nodal Center Needs to ensure that all covid -19 protocol is followed by all the participants, guest etc.
- Do Arrange for Chief Guest for Opening as well as Prize Distribution Ceremonies
- Do allow teams to place their standees and banners etc.
- Do allow teams to take rest in different sets
- Do allow teams to stay on campus at least till June 26, 2021 noon, depending upon the schedule of their return journey.
- Do create a WhatsApp Group and a bridge for all communications with the help of the Student Coordination Committee that you appoint internally
- Consumables procured by the nodal centers for the student teams will be carried back with the teams after the hackathon. Nodal centers are requested to take approvals on purchase prior to the hackathon and not after.

### DON'Ts for the Nodal Center

- Do not let students register on or before June 21, 2021
- Do not let teams change up to 3 team members prior to the start of the hackathon. They will bring a letter from college to support this change.
- Do not allow Drinking liquor on campus
- Do not allow consuming any form of drugs without a prescription on campus
- Do not allow judges to leave the arena at the time when their activity has been scheduled.

PRINCIPAL  
 Gaethanjali College of Engg. Tech.  
 Choeryal (V), Keesara (M), K.R. Dist. (A.P.) - 501 301





Geethanjali

Phone : 9182058187  
Website: www.geethanjaliinstitutions.com  
info@gcet.edu.in

# Geethanjali College of Engineering and Technology

## AUTONOMOUS

(Accredited by NAAC "A" Grade; ECE, CSE, EEE & ME, B.Tech Programs Accredited by NBA;  
Approved by AICTE, New Delhi; Permanently Affiliated to JNTUH)  
Sy. No. 33 & 34, Cheeryal (V), Keesara (M), Medchal District. - 501 301.

20<sup>th</sup> Oct 2020

### Letter of Appreciation.

This is to acknowledge and appreciate the talk delivered by Dr. Siva Shankar S. on "Intellectual property Rights – documentation and Claims" using virtual a tool (Google Meet). The participants included students and faculty from Geethanjali college of Engineering and Technology and also from other colleges.

I/C Incubation Center,

Dr. Anil Kumar Puppala

Principal,

**PRINCIPAL**

**Geethanjali College of Engg. and Tech.**  
Cheeryal (V), Keesara (M), Medchal Dist.(T.S.)-501 301.

Dr. Udaya Kumar Susarla

**PRINCIPAL**

**Geethanjali College of Engg. Tech.**  
Cheeryal (V), Keesara (M), R.R. Dist. (T.S.)- 501 301.

Sponsored by **TEJA EDUCATIONAL SOCIETY, HYDERABAD**

Office : Sy. No. 33 & 34, Cheeryal (V), Keesara (M), Medchal Dist. - 501 301.

Phones : 9182058196, 9182058194



Geethanjali

Phone : 9182058187

Website: www.geethanjaliinstitutions.com  
info@gcet.edu.in

# Geethanjali College of Engineering and Technology

## AUTONOMOUS

(Accredited by NAAC "A" Grade; ECE, CSE, EEE & ME, B.Tech Programs Accredited by NBA;  
Approved by AICTE, New Delhi; Permanently Affiliated to JNTUH)  
Sy. No. 33 & 34, Cheeryal (V), Keesara (M), Medchal District. - 501 301.

1<sup>st</sup> July 2021

### Letter of Appreciation

This is to acknowledge and appreciate Mr. K Sharat Chandra, Co-founder of Butterfly Fields Pvt. Ltd. for gracing the inaugural ceremony of 'Toycathon' as Guest of Honor at Geethanjali College of Engineering and Technology (GCET). GCET was selected as one of the few nodal centers to partner with AICTE to conduct it from 22<sup>nd</sup> – 26<sup>th</sup> Jun 2021, in partnership with All India Council for Technical Education (AICTE).

Toycathon was a three day Hackathon which was centrally organized by AICTE in collaboration with six ministries of Government of India. Mr. K Sharat Chandra inputs to the participants and GCET's incubation center were very valuable.

I/C Incubation Center

Dr. Anj Kumar Puppala

Principal

Dr. Udaya Kumar Susarla

**PRINCIPAL**  
Geethanjali College of Engg. and Tech.  
Cheeryal (V), Keesara (M), Medchal Dist. (T.S.)-501 301.

**PRINCIPAL**  
Geethanjali College of Engg. Tech.  
Cheeryal (V), Keesara (M), R.R. Dist. (A.P.) - 501 301

Sponsored by **TEJA EDUCATIONAL SOCIETY, HYDERABAD**

Office : Sy. No. 33 & 34, Cheeryal (V), Keesara (M), Medchal Dist. - 501 301.

Phones : 9182058196, 9182058194





Geethanjali

Phone : 9182058187

Website: www.geethanjaliinstitutions.com  
info@gcet.edu.in

# Geethanjali College of Engineering and Technology

## AUTONOMOUS

(Accredited by NAAC "A" Grade; ECE, CSE, EEE & ME, B.Tech Programs Accredited by NBA;  
Approved by AICTE, New Delhi; Permanently Affiliated to JNTUH)  
Sy. No. 33 & 34, Cheeryal (V), Keesara (M), Medchal District. - 501 301.

1<sup>st</sup> July 2021

### Letter of Appreciation

This is to acknowledge and appreciate Mr. Kondaveeti Sudheer Reddy, president of Telangana Industrialists Federation (TIF) for gracing the inaugural ceremony of 'Toycathon' as Chief Guest at Geethanjali College of Engineering and Technology (GCET). GCET was selected as one of the few nodal centers to partner with AICTE to conduct it from 22<sup>nd</sup> – 26<sup>th</sup> Jun 2021, in partnership with All India Council for Technical Education (AICTE).

Toycathon was a three day Hackathon which was centrally organized by AICTE in collaboration with six ministries of Government of India. Mr. Sudheer Reddy's inputs to the participants were very valuable.

I/C Incubation Center

Dr. Anil Kumar Puppala

Principal

Dr. Udaya Kumar Susarla

**PRINCIPAL**  
Geethanjali College of Engg. and Tech.  
Cheeryal (V), Keesara (M), Medchal Dist. (T.S.)-501 301

**PRINCIPAL**  
Geethanjali College of Engg. Tech.  
Cheeryal (V), Keesara (M), R.R. Dist. (A.P.) - 501 301

Sponsored by **TEJA EDUCATIONAL SOCIETY, HYDERABAD**

Office : Sy. No. 33 & 34, Cheeryal (V), Keesara (M), Medchal Dist. - 501 301.

Phones : 9182058196, 9182058194



# Geethanjali College of Engineering and Technology

CHEERYAL (V), KEESARA (M), Medchal DIST-501301, Telangana

Report

On

Webinar on "Steps to Startup" by EDC in association with CACG

Sunday, 6 June 2021

Google Meet joining info

Video call link: <https://meet.google.com/hic-jguq-vzu>

Or dial: (US) +1 617-675-4444 PIN: 109 583 520 5725#

More phone numbers: <https://tel.meet/hic-jguq-vzu?pin=1095835205725>

Students Benefitted: 96

Faculty attended: 22

Advertisement on Social Media

<https://twitter.com/geethanjalites/status/1400823766091898885>

  
Principal  
Geethanjali College of Engg. and Tech.  
Cheeryal (V), Keesara (M), Medchal Dist.(T.S.)-501 301.



## Gallery

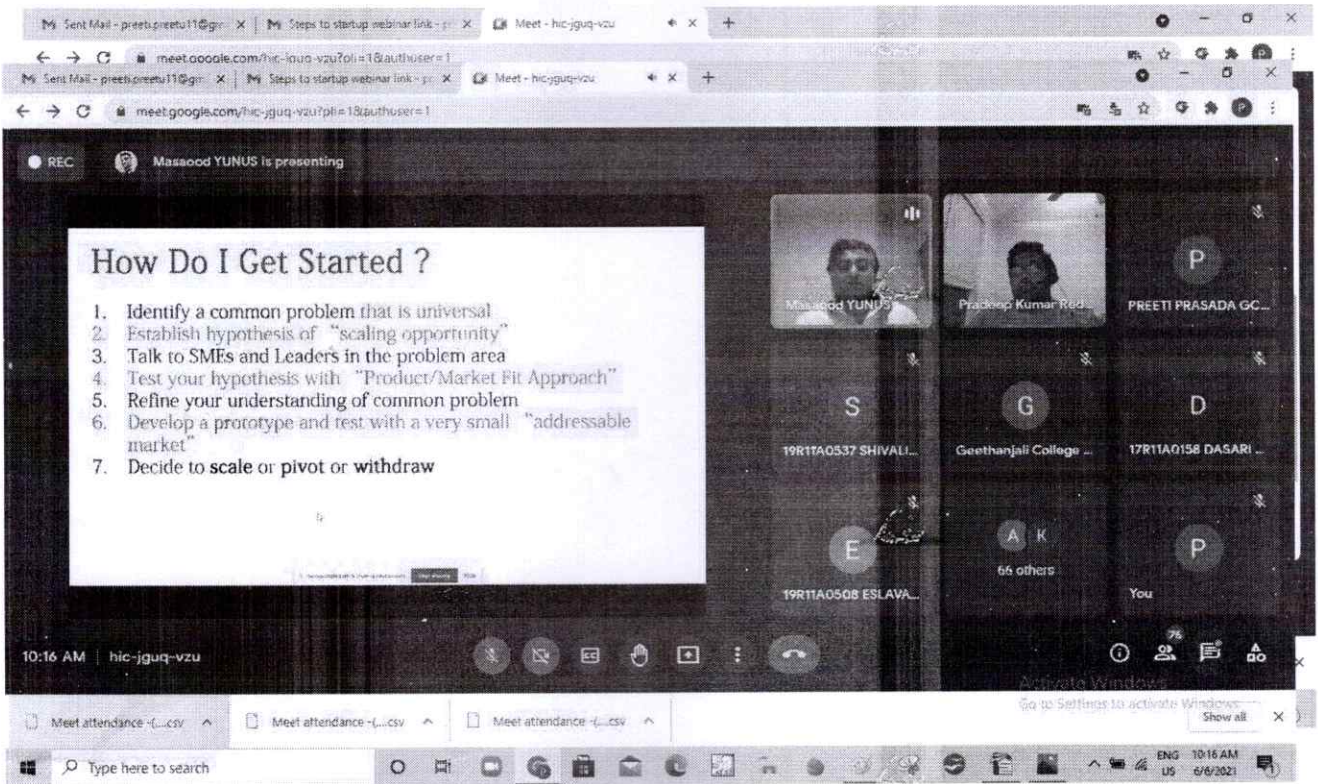

Attendance bot: dev(Pavan:p2pdops@gmail.com) on 2021-06-06 : 9:39:  
<https://meet.google.com/hic-jguq-vzu?pli=1&authuser=1>

**Members present : 96 (Duplicates removed)**

16R11A0240 P NAVEEN KUMAR  
17R11A02A3 TENNETI SAI PRASHANTH  
17R11A0534 OGIRALA SAI SREE RAM  
17R11A0580 P NITHISH KUMAR  
18R11A0210 BUSHIGAMPALA SRAVANI GOUD  
18R11A0221 GOLI CHAKRADHAR REDDY

*Sak*  
**PRINCIPAL**  
Geethanjali College of Engg. and Tech  
Cheeryal (V), Keesara (M), Medchal Dist.(T.S.)-501 301.

20R11A0434 MAMIDI BABU NAGA SRINIVASA RAO  
20R11A0440 PAIDIMALLA MADHAN  
20R11A0441 PALUGULA HEMANTHKUMAR  
20R11A04E4 KODIMALA VARSHA  
20R11A04G5 SEELAM BHARGAV TEJA  
20R11A04J2 BANOTH RAJENDER NAIK  
20R11A04N1 PACHEPPA BHASKAR SNEHA LATHA  
20R11A04P1 SADAM SAI NITHISHA  
20R11A04P9 YEJARLA BRAHMANI  
20R15A0207 BANOTH SRIDHAR  
20R15A0217 MANCHALA VAMSHI YUVA RAJ  
20R15A0502 Mr. AMRAJ RAJESH KUMAR  
20R15A0504 Mr. ORAGANTI ROHITH GOUD  
20R15A0506 Mr. VARUSA MAHESH CHANDRA  
20R15A0507 Miss BANDOJU RAVALI  
20R15A0508 Miss VELLANKI MOUNIKA  
20R15A0516 Mr. VANAMALA NITHIN  
497 Prathyusha  
5E5 Akshitha Yerram  
A.CHANDRAKALA GCET  
APPALA RAJU UPPALA GCET  
Anudeep vanagarouthu  
CHOLLETI VIKAS GCET  
Chandra Karan  
Dr.S.SPANDANA GCET  
G.Charith Raghav  
Geethanjali College Engineering and Technology  
JUNAID MOHAMMAD  
Kishore Babu  
M MADHAVI GCET  
M VIJAY BHASKER REDDY GCET  
MADHURI BAYYA GCET  
Manikant P  
Manikanta Sambari  
Masaoood YUNUS  
P HARITHA GCET  
PREETI PRASADA GCET  
PavanKumar GK  
Pradeep Kumar Reddy Nalamada  
Rahul M  
Ravikanth Thogarcheti GCET  
S.RADHA GCET

  
PRINCIPAL  
Geethanjali College of Engg. and Tech  
Cheeryal (V), Nee sare (M), Medchal Dist.(T.S.)-501 301.



# Geethanjali College of Engineering and Technology

CHEERYAL (V), KEESARA (M), Medchal DIST-501301, Telangana

Report of

## “From your Ph.D./ Masters Thesis to a start-up”

23<sup>rd</sup> April 2021 11:00 Am

(MIC Driven Activity)

Some of the pictures of the session:

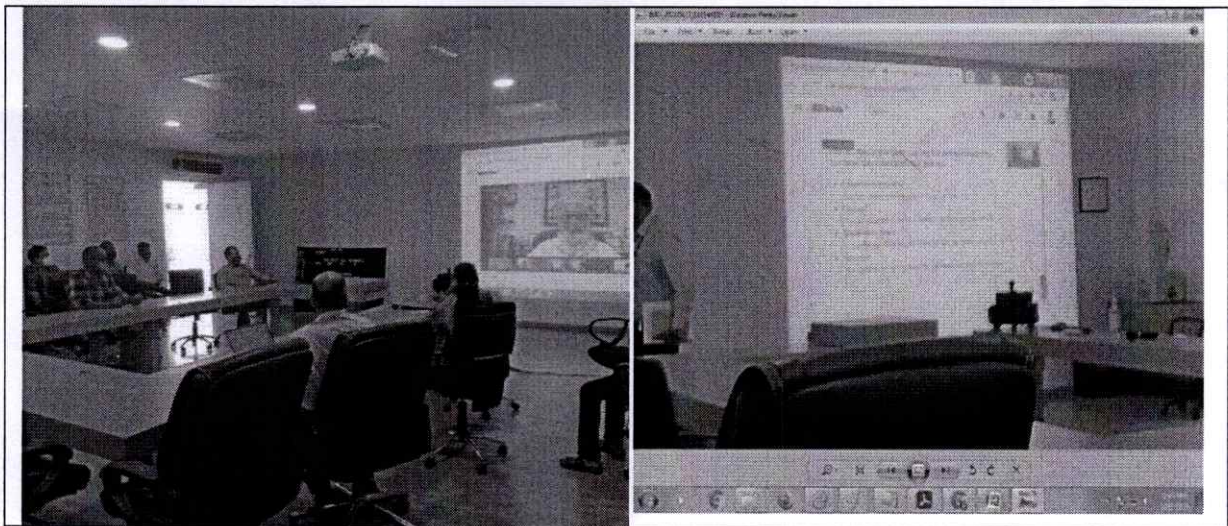

  
**PRINCIPAL**  
Geethanjali College of Engg. Tech.  
Cheeryal (V), Keesara (M), R.R. Dist. (A.P.) - 501301

Mr. Srikanth Assoc Prof Dept of EEE

Mr. Poorna CHander Rao, Asst Prof, Dept of EEE

Mr. Vikas Dept of CSE

Ms. Preethi Prasada, Dept of CSE

Dr. Nagamani, Dept of Freshman Engineering.

Dr. Anil Kumar Puppala (I/C Incubation Center)

Dr. Prasanna Kumar HoD Dept of Civil Engg.

Mr. OVPR Siva Kumar Professor, ECE Dept.

Mr. Aditya Asst Professor, EEE Dept

Ms. Jyothirmaree Assoc Professor, Dept of ECE

Mr. Sudershan Rikka, Assoc Professor Dept of ME

Dr. Devaiah Malkapuram, HoD Dept of ME.

- The process of lean startup process is well understood.
- The works of Steve Blank, Eric Ries , Alexander Osterwalder, Clayton Christiansen the speaker has given an indepth process that is to be laid out while taking the PhD thesis to product level was very well appreciated by the participants
- All the participants opined that - Books suggested like Beyond the summit – Todd Skinner, Four steps to the empathy – Steve Blank, Startup way –Eric Ries, The lean startup, The startup Owner’s manual etc were all will be useful.
- “Every business is the same inside” is the concept that was very well understood
- “The factors of comparison” for all businesses is the same
- The session concluded by Dr. Anil Kumar Puppala I/C IIC council at GCET and thanking the members who attended the session.

Session attended at

<https://www.youtube.com/watch?v=bS-0WbelzFc>

PRINCIPAL  
Gochanelli College of Engg. Tech.  
Tatyral (V), Keesara (M), R.R. Dist. (A.P.) - 501 301





## Geethanjali College of Engineering and Technology

CHEERYAL (V), KEESARA (M), Medchal DIST-501301, Telangana

### Students Registered for IGNITE (JHuB) Workshop for the AY 2020-21

A series of six 2 day IGNITE workshop

List of registered Students for workshop on 19-20 feb 2021

S.No	Roll Number	Student Name
1	20R11A05L7	M Vansh
2	20R11A04B6	V. Bhoomika
3	20R11A0539	M.Deepika
4	20R11A6943	P.Sathvik
5	20R11A05K9	Hari Sarada
6	20R11A0492	M Shatananda Sharma
7	20R11A0426	K Supraja
8	20R11A0496	Sharan Naaroju
9	20R11A6759	VA Tanmai
10	20R11A6746	S Sai Keertana
11	20R11A04D0	D.Aakanksha
12	20R11A6952	S varun reddy
13	20R11A6259	Vempaty Bhanu Vamsi
14	20R11A05M4	M . Riddhi
15	20R11A0444	R Saunak Jain
16	20R11A05B7	V Bhavana

PRINCIPAL  
Geethanjali College of Engg. Tech.  
Cheeryal (V), Keesara (M), R.R. Dist. (A.R.) - 501301

18	20R11A0468	Yamini sri bhavya
19	20R11A6616	D Chandra Shekar
20	20R11A0209	E. Preethi
21	20R11A0232	P.Srikanth
22	20R11A1208	B.Deepana
23	20R11A04G9	Surnilla Vaishnavi
24	20R11A6703	Aryan Kodte
25	20R11A0579	G Dattha krishna
26	20R11A6729	M.Chaithanya Lahari
27	20R11A6624	k.Sai Teja
28	20R11A0566	Apoorva Gitti.
29	20R11A04C5	Bhagavatula Druva Kumar
30	20R11A6952	S varun reddy
31	20R11A0569	Bhartipudi Saketh Ram
32	20R11A6928	K sai goutham
33	20R11A0101	Roopa chandrika
34	20R11A04K4	G Naga Lokesh
35	20R11A6941	P Sai Aditya
36	20R11A6754	T gopi chand reddy
37	20R11A0145	R sai Chetan
38	20R11A05E6	Kasturi Anusha
39	20R11A04M0	M Karthik
40	20R11A0147	K Sai Karthik
41	20R11A05E5	Kapaka Sri Krishna Koushik
42	20R11A04B4	T Venkata Sai Anirudh
43	20R11A0552	Shrikeraa Beraar
44	20R11A6928	k sai goutham

Series of six 2 day IGNITE workshop

PRINCIPAL  
Geethanjali College of Engg. Tech.  
Cheeryal (V), Keesara (M), R.R. Dist. (A.P.) - 501 301



1	20R11A0405	Asifa Anjum Shaik
2	20R11A05P9	V.Lahari
3	20R11A05M7	Namitha Joanne
4	20R11A05N4	J.poorvi
5	20R11A04C1	A.varsha

  
PRINCIPAL  
Geethanjali College of Engg. Tech.  
Cheerayal (V), Kousuru (M), R.R. Dist. (A.P.) - 501 301

**Report**  
**on**  
**Idea Pitching Competition**  
**Date: 12<sup>th</sup> Dec 2020**

**Number of student (teams) participated: 68**

**Expert Panel:**

**Mr. SriCharan Lakkaraju. Entrepreneur, 2018 - 30Forbes under 30 listed.**

**Mr. Dr. Rohin Kumar Yeluripati Entrepreneur/Startup**

**Mr. Chitti BadriNath, Expert identified by JHub JNTUH.**

**All the ideas selected were submitted to AICTE-Chhatra Vishwakarma Awards competition.**

Some of the pictures:



**PRINCIPAL**  
Sriesthanjali College of Engg. Techn.  
Cheeryal (V), Keesara (M), R.R. Dist. (A.P.) - 501 301



**TEJA EDUCATIONAL SOCIETY**  
Office No. 33 & 34, Cheral (V), Koster (M), Medchal Dist. (T.S.) - 501301  
Phones: 912208190, 912208196, 912208198

Payment Method (Cash/Bank)	V.No. <u>1645</u>	Document Date <u>17.12.2020</u>	
PAY TO <u>Mr. Chellu Bodinreddy</u>			
Payee <u>Teja Educational Society</u>			
Account Head	Particulars	Rs.	Pk.
	<u>Teja Educational Society</u>		<u>10000/-</u>
	<u>Chassis 6123786</u>		
Accountant Signature	Authoriser Signature	Receiver's Signature	

**TEJA EDUCATIONAL SOCIETY**  
Office No. 33 & 34, Cheral (V), Koster (M), Medchal Dist. (T.S.) - 501301  
Phones: 912208190, 912208196, 912208198

Payment Method (Cash/Bank)	V.No. <u>1646</u>	Document Date <u>19.12.2020</u>	
PAY TO <u>Mr. Pavan Kumar Yelamkoti</u>			
Payee <u>Teja Educational Society</u>			
Account Head	Particulars	Rs.	Pk.
	<u>Teja Educational Society</u>		<u>10000/-</u>
	<u>Chassis 649283</u>		
Accountant Signature	Authoriser Signature	Receiver's Signature	

**TEJA EDUCATIONAL SOCIETY**  
Office No. 33 & 34, Cheral (V), Koster (M), Medchal Dist. (T.S.) - 501301  
Phones: 912208190, 912208196, 912208198

Payment Method (Cash/Bank)	V.No. <u>1647</u>	Document Date <u>19.12.2020</u>	
PAY TO <u>Mr. Sri Chandra Lakshmi</u>			
Payee <u>Teja Educational Society</u>			
Account Head	Particulars	Rs.	Pk.
	<u>Teja Educational Society</u>		<u>10000/-</u>
	<u>Chassis 645288</u>		
Accountant Signature	Authoriser Signature	Receiver's Signature	

**PRINCIPAL**  
Geethanjali College of Engg. Tech.  
(Cheral (V), Koster (M), K.R. Nagar (P.O.) Medchal Dist.)

Titles of the winning teams are not being listed here purposefully as patenting of the ideas (supported by the Institute) is being considered for the ideas.

	Name	Roll No.	Branch	Year	Other Remarks
[REDACTED]	O. SaiVarun	19R11A0329	ME	1 <sup>st</sup>	
	Ch. Srinivas	19R11A0307	ME	1 <sup>st</sup>	
	Sree Harsha	19R11A04 ??	ECE	1 <sup>st</sup>	
Vrikorder.com	V Aravind	18R11A03B0	ME	3 <sup>rd</sup>	
	R Narender	18R11A03A2	ME	3 <sup>rd</sup>	
[REDACTED]	These teams did not submit form – “Suggestions given by the jury” which includes the team details as well.				
[REDACTED]					Further Research is needed – Sideeffects of TiO <sub>2</sub>
[REDACTED]					

The following are the winning teams

  
**PRINCIPAL**  
 Geethanjali College of Engg. Tech  
 Cheeryal (V), Keesara (M), K.L. Dist. (A.P.) - 501304



10/12/2020

To  
The Principal,  
Geethanjali college of Engineering and Technology,  
Cheeryal, Hyderabad

Subject: Request for approval of budget for conducting ideation session.

Incubation center of GCET is planning to organize an ideation session on 12<sup>th</sup> Dec 2020 as per the internal circular dated 30<sup>th</sup> Oct 2020. The following is the budgetary requirements.

S. No.	Description	Cost (INR)
1.	Transportation	2,100
2.	Lunch/Food 5-6 people	600
3.	Stationery	500
4.	Honorarium = 4000*3	12,000
	Total	15,200

It is kindly requested to approve the same.

Thanking You  
Anil Kumar Puppala

In charge Incubation Center  
GCET

Submitted to Secretary  
for approval

Suk  
9/10/12/20

Secretary

PRINCIPAL  
Geethanjali College of Engg. Tech  
Cheeryal (V), Keesara (M), R.R. Dist. (A.P.) - 501

Team Number/Name: 15.

S.No	Name	Roll no	Branch & Year	Contact	Email Id.
1	C. Sridhar Reddy	17RI1A0205	EEE-4 <sup>th</sup>	9172262114	chsridharreddy16@gmail.com
2	V. Sanjay	17RI1A0251	EEE-4 <sup>th</sup>	7981745939	V.Sanjay2000@gmail.com
3	P. Sri bhargav	17RI1A0248	EEE-4 <sup>th</sup>	9553685251	bhargav.junnu@gmail.com
4	Varun Masimganti	17RI1A0231	EEE-4 <sup>th</sup>	8121542945	varun.masimganti@gmail.com
5	A. Venkat Kaushik	17RI1A0201	EEE-4 <sup>th</sup>	9908943816	VenkatKaushik4516@gmail.com
6	C. Yogesh Ram	17RI1A0206	EEE-4 <sup>th</sup>	8978962988	C.yogeshram@gmail.com

Title - Idea:-

Hand gesture controlled wheel chair.

Utility of the Idea:-

Technical Feasibility:-

PRINCIPAL  
 Gaethanjali College of Engg. Tech  
 Chervyl (V), Keesara (M), R.N. Dist. (A.P.)



# Geethanjali College of Engineering and Technology

CHEERYAL (V), KEESARA (M), Medchal, District-501301, Telangana

## IDEATHON

Team Number	Title	Novelty	Tech Feasibility	Marketing feasibility	Financial Viability	Scalability	social cost benefit analysis	Potential for future additions/progressions	Total	Feedback / Remarks
		(20Marks)	(10Marks)	(10Marks)	(10Marks)	(20Marks)	(20Marks)	(10Marks)	(100 M)	
1.	Mental health app	10	5	2	3	10	12	8	50	
2.	Public transport Disinfection.	8	6	5	4	10	12	7	52	No proper pptx
3.	Personal Health information	8	3	3	2	8	10	3	37	ppts are not clear.
4.	Smart App (IoT)	5	2	2	3	6	10	2	30	No clarity
5.	Cough Sensing & Automatic Sanitizer	15	8	6	8	15	15	8	75	Wonderful idea
6.	Vn'korder.	10	7	6	7	10	12	7	59	

Dr. B. V. Swathi  
Name of the Jury Member

*B. Swathi*  
Signature

# Geethanjali College of Engineering and Technology

CHEERYAL (V), KEESARA (M), Medchal, District-501301, Telangana

## IDEATHON

Team Number	Title									Feedback / Remarks
		Novelty	Tech Feasibility	Marketing feasibility	Financial Viability	Scalability	social cost benefit analysis	Potential for future additions/progressions	Total	
		(20Marks)	(10Marks)	(10Marks)	(10Marks)	(20Marks)	(20Marks)	(10Marks)	(100 M)	
	More clarity on the specific things to be included in the presentation	10	10	10	10	10	10	10	100	1. Mental Health on Desktop
	Public transport on Desktop	10	10	10	10	10	10	10	100	2. Personal Health
	Personal Health	10	10	10	10	10	10	10	100	3. Personal Health
	Personal Health	10	10	10	10	10	10	10	100	4. Personal Health
	Personal Health	10	10	10	10	10	10	10	100	5. Personal Health

**Geethanjali College of Engineering and Technology**  
**PRINCIPAL**  
 Cheeryal (V), Keesara (M), R.R. Medchal, A.M.I., 501301

Name of the Jury Member

Signature



# Geethanjali College of Engineering and Technology

CHEERYAL (V), KEESARA (M), Medchal, District-501301, Telangana

## IDEATHON

Team Number	Title	Novelty	Tech Feasibility	Marketing feasibility	Financial Viability	Scalability	social cost benefit analysis	Potential for future additions/progressions	Total	Feedback/Remarks
		(20Marks)	(10Marks)	(10Marks)	(10Marks)	(20Marks)	(20Marks)	(10Marks)	(100 M)	

Geethanjali College of Engg. Tech.  
 Cheeryal (V), Keesara (M), Dist. Medchal, A.P. - 501301  
**PRINCIPAL**

Name of the Jury Member

Signature

*Dr. E. V. Lakshmi*





# Geethanjali College of Engineering and Technology

CHEERYAL (V), KEESARA (M), Medchal, District-501301, Telangana

## IDEATHON

Team Number	Title								Potential for future additions/progressions	Total (100 M)	Feedback (Remarks)
		Novelty	Tech Feasibility	Marketing feasibility	Financial Viability	Scalability	social cost benefit analysis				
		(20Marks)	(10Marks)	(10Marks)	(10Marks)	(20Marks)	(20Marks)	(10Marks)			
<del>6</del>	<del>Vrikoder</del>	<del>17</del>	<del>8</del>	<del>8</del>	<del>7</del>	<del>18</del>	<del>17</del>	<del>9</del>	<del>84</del>	<del>Need to work on marketing model.</del>	
<del>7</del>	<del>Flower Knitting machine</del>	<del>17</del>	<del>9</del>	<del>8</del>	<del>8</del>	<del>18</del>	<del>18</del>	<del>9</del>	<del>87</del>		<del>Idea development</del>
<del>8</del>	<del>Organic cultivation without soil</del>	<del>8</del>	<del>4</del>	<del>2</del>	<del>2</del>	<del>6</del>	<del>8</del>	<del>4</del>	<del>34</del>	<del>Nothing innovative [Confused]</del>	
<del>9</del>	<del>AI-Doctor</del>	<del>15</del>	<del>15</del>	<del>8</del>	<del>4</del>	<del>12</del>	<del>10</del>	<del>6</del>	<del>70</del>	<del>Huge project</del>	
<del>10</del>	<del>GLUCK</del>	<del>12</del>	<del>4</del>	<del>4</del>	<del>4</del>	<del>10</del>	<del>14</del>	<del>7</del>	<del>55</del>	<del>Link to first person</del>	
<del>11</del>	<del>Doctor or medical Shop recommendation</del>	<del>10</del>	<del>2</del>	<del>2</del>	<del>2</del>	<del>2</del>	<del>5</del>	<del>2</del>	<del>25</del>	<del>No novelty</del>	
<del>12</del>	<del>mobile POS system</del>	<del>12</del>	<del>7</del>	<del>7</del>	<del>7</del>	<del>15</del>	<del>12</del>	<del>7</del>	<del>67</del>	<del>too much complicated</del>	
<del>13</del>	<del>13</del>	<del>15</del>	<del>5</del>	<del>6</del>	<del>5</del>	<del>10</del>	<del>8</del>	<del>5</del>	<del>54</del>	<del>Existing ideas</del>	

Related to first item

Name of the Jury Member

Dr. Harsha Praneeth

Signature



Geethanjali College of Engineering and Technology  
 Cheeryal (V), Keesara (M), R.R. Dist. (A.P.) - 501301.



# Geethanjali College of Engineering and Technology

CHEERYAL (V), KEESARA (M), MedchalDIST-501301, Telangana

Team Number	Title	Novelty	Tech Feasibility	Marketing feasibility	Financial Viability	Scalability	social cost benefit analsis	Potential for future additions/ progressi ons	Total	Feedback/Remarks
		(20Marks)	(10Marks)	(10Marks)	(10Marks)	(20Marks)	(20Marks)	(10Marks)	(100 M)	
10.	Gluck. (Covid virtual friend)	5	7	6	-	-	-	-	-	Gluck - nice name. branding is good...
11.	Doctor or Medical shop recommendation app	-	-	-	-	-	-	-	-	Connect with AI-Doctor - team 9.
12.	Mobile POS system SEM Small for the small	12	6	2	3	10	10	2	45	<del>7</del>
13.	Drowsiness detection	2	6 (the way they propose)	-	-	-	-	-	-	
14.	Smart headphones for delivery personnel to avoid accidents.	4	6	2	3	2	5	-	22	

PRINCIPAL  
 Geethanjali College of Engg. Techn.  
 Cheeryal (V), Keesara (M), Medchal (A.R. Dist.) - 501301

Name of the Jury Member

Rohay Y

Signature

*[Handwritten Signature]*

PTO



Combine  
T & A

# Geethanjali College of Engineering and Technology

CHEERYAL (V), KEESARA (M), Medchal, District-501301, Telangana

## IDEATHON

Team Number	Title	Novelty	Tech Feasibility	Marketing feasibility	Financial Viability	Scalability	social cost benefit analysis	Potential for future additions/progressions	Total	Feedback/Remarks
		(20Marks)	(10Marks)	(10Marks)	(10Marks)	(20Marks)	(20Marks)	(10Marks)	(100 M)	
CSE	1									
	2	✓	✓	✓	✗	✗	✗	✗		
	3	?	✗	✓	✓	-	-	-		
	4	✓	✓	✓	-	-	-	-		
	5	-	-	-	-	-	-	-		
	6	✓	-	✓	✓	✓	✓	✓		

Funding?

T Hub - Innovator  
Monithra  
Healthcare

Bharath Aji  
Shakti Times

PRINCIPAL  
Geethanjali College of Engg. Techn.  
Cheeryal (V), Keesara (M), R.R. Dist. (A.P.) - 501301

Name of the Jury Member

Signature

- How can you not remember your competitor - ? - You will, Does Apps
-

# Geethanjali College of Engineering and Technology

CHEERYAL (V), KEESARA (M), MedchalDIST-501301, Telangana

Team Number	Title	Novelty	Tech Feasibility	Marketing feasibility	Financial Viability	Scalability	social cost benefit analysis	Potential for future additions/progressions	Total	Feedback/Remarks
		(20Marks)	(10Marks)	(10Marks)	(10Marks)	(20Marks)	(20Marks)	(10Marks)	(100 M)	
14.	Smart headlamps for delivery persons to avoid accidents from oncoming traffic	12	6	5	5	10	10	5	53	TOO Complicated
15.	e-farmer Portal development	10	5	5	5	10	10	5	50	existing model
16.	Justine Controlled wheel chair	16	58	57	37	14	16	6	74	Need to work on the model
17.	Fire Fighting fan	15	6	6	5	10	12	5	59	Need to develop the model
18	women safety bag									

Geethanjali College of Engg. Tech.  
 CHEERYAL (V), KEESARA (M), MedchalDIST-501301  
 PRINCIPAL

Name of the Jury Member

Signature



# Geethanjali College of Engineering and Technology

CHEERYAL (V), KEESARA (M), MedchalDIST-501301, Telangana

## Suggestions/Remarks given by the Jury

Date: 12/12/20

(14) (13)

Team Number/Name: Smart headphones for delivery personnel to avoid accidents.

S.No	Name	Roll Number	Branch and Year	Contact	Email id
1.	L. Akhila	18R11A0232	EEE - III	8074984870	lagudualchila@gmail.com
2.	S. Paramesh	18R11A0248	EEE - III	6305757586 6302505306	parameshyadav1636@gmail.com
3.	K. Madhukailash	18R11A0231	EEE - III	9177311285	

Title - idea Smart headphones for delivery personnel to avoid accidents.

### Novelty of the idea:

(Patent/market/Literature search)

Cannot be legalised.

### Technical Feasibility:

Use of a mobile app is suggested instead of embedding sensors into head phones.

PRINCIPAL  
Geethanjali College of Engg. Tech.  
Cheeryal (V), Keesara (M), R.R. Dist. (A.P.) - 501301

# Geethanjali College of Engineering and Technology

CHEERYAL (V), KEESARA (M), MedchalDIST-501301, Telangana

Suggestions/Remarks given by the Jury

Date: 12/12/2020

③

Team Number/Name:

S.No	Name	Roll Number	Branch and Year	Contact	Email id
1	G. AKHILA	18R11A0483	ECE-3B	93909-13012	gaddamakhila200@gmail.com
2	Pavan Vaswani	18R11A0483	ECE-3B	70132-21467	pavan.vaswani0@gmail.com
3	S. Ramya	18R11A0488	ECE-3B	9010647692	ramya.samala555@gmail.com
4	S. Abhishek	18R11A0489	ECE-3B	6304782071	18R11A0489@gmail.com

Title - idea

Smart Agriculture using IoT

Novelty of the idea:

(Patent/market/Literature search

Implementation of IoT technology in agriculture sector.

Technical Feasibility:

A prototype model can be developed & will be implemented successfully.

PRINCIPAL  
Geethanjali College of Engg. Tech.  
Cheeryal (V), Keesara (M), R.A. Dist. (A.P.) - 501301



# Geethanjali College of Engineering and Technology

CHEERYAL (V), KEESARA (M), MedchalDIST-501301, Telangana

Suggestions/Remarks given by the Jury

Date: 12/12/20

8

Team Number/Name:

S.No	Name	Roll Number	Branch and Year	Contact	Email id
1.	K. Snehlitha	18R11A0517	BCSE - III	8341633311	kolasnethitha484@gmail.com
2.	B. Abhishek	18R11A0554	CSE - III	9704513447	abhishekbhemisetty@gmail.com
3.	P. Sumanth	18R11A05D1	CSE - III	9553224619	sumanthpola959@gmail.com
4.	D. Sweekuithi	18R11A0561	CSE - III	8309113792	sweekuithi.0102@gmail.com

Title - idea

AI doctor

Novelty of the idea:

(Patent/market/Literature search)

Easy to use. End-to-end encryptions to chat

Technical Feasibility:

Requires a large scale database

PRINCIPAL  
Geethanjali College of Engg. Tech.  
Cheeryal (V), Keesara (M), R. Dist. (A.P.) - 501301

# Geethanjali College of Engineering and Technology

CHEERYAL (V), KEESARA (M), MedchalDIST-501301, Telangana

Suggestions/Remarks given by the Jury

Date: 12/12/2020

10

Team Number/Name:

S.No	Name	Roll Number	Branch and Year	Contact	Email id
1	T. Vishnu Vardhan Reddy	18R11A0592	CSE - 3 <sup>rd</sup>	6301625790	vishnuvardhanreddy24112000@gmail.com
2	A. Harish Kumar Gupta	18R11A0364	MECH - 3 <sup>rd</sup>	9059025435	harishanchuri44@gmail.com
3	P. Haneesh Reddy	18R11A05PB	CSE - 3 <sup>rd</sup>	8790497716	haneeshreddy02@gmail.com
4	V. Ravi Kiran Reddy	18R11A03B4	MECH - 3 <sup>rd</sup>	7995548375	ravikiranreddy585@gmail.com

Title - idea

Doctor or medical shop recommendation App

Novelty of the idea:

(Patent/market/Literature search)

Technical Feasibility:

PRINCIPAL  
Geethanjali College of Engg. Tech.  
(Cheeryal (V), Keesara (M), R.R. Dist. (A.P.) - 501301)



# Geethanjali College of Engineering and Technology

CHEERYAL (V), KEESARA (M), MedchalDIST-501301, Telangana

## Suggestions/Remarks given by the Jury

Date: 12/12/2020

11

Team Number/Name:

S.No	Name	Roll Number	Branch and Year	Contact	Email id
①	K. Sanketh	17R11A0162	C.E	9328453265	Kodukuntla.sanketh.saj 56@gmail.com
②	T. Vishnuvardhan	18R11A0592	C.SE	6301625790	vishnuvardhan.reddy 24112000@gmail.com
③	R.S DAVID	17R11A0138	C.E	8341518608	R.S.David@gmail.com

Title - idea

mobile point on sale system & supply chain management system. (mobile pos & scm system)

Novelty of the idea:

(Patent/market/Literature search)

Technical Feasibility:

PRINCIPAL  
Geethanjali College of Engg. Tech.  
Cheeryal (V), Keesara (M), R.R. Dist. (A.P.) - 501301

# Geethanjali College of Engineering and Technology

CHEERYAL (V), KEESARA (M), MedchalDIST-501301, Telangana

Suggestions/Remarks given by the Jury

Date: 12/12/2020

Team Number/Name:

S.No	Name	Roll Number	Branch and Year	Contact	Email id
1.	K. Srilatha	18R11A05A9	CSE - III <sup>rd</sup>	8341149392	kakalassrilatha73@gmail
2.	Ashok	18R11A05B7	CSE - IV <sup>th</sup>	9000775850	ashokgajapathi.raj@gmail.com
3.	Hari Ramakrishna	18R11A05B9	CSE - III <sup>rd</sup>	7013447604	harirama@gmail.com
4.	P. Bhumiika	18R11A05C3	CSE - III <sup>rd</sup>	9704120019	bhumiikakurruy@gmail.com
5.	P. Nikhila	18R11A05C6	CSE - III <sup>rd</sup>	7729932727	nikhilapalkampally05@gmail.com
6.	M. Karunasri	18R11A05C2	CSE - III <sup>rd</sup>	9704333335	mettukarunasri@gmail.com

Title - idea

AI/ML and IOT Application for Drowsiness Detection And Alert System.

Novelty of the idea:

(Patent/market/Literature search)

Technical Feasibility:

PRINCIPAL  
Geethanjali College of Engg. Tech.  
Cheeryal (V), Keesara (M), R.R. Dist. (A.P.) - 501301



# Geethanjali College of Engineering and Technology

CHEERYAL (V), KEESARA (M), MedchalDIST-501301, Telangana

Suggestions/Remarks given by the Jury

Date: 12/12/20

(14)

Team Number/Name: G. V. Charan kalyan

S.No	Name	Roll Number	Branch and Year	Contact	Email id
01	G.V. Charan kalyan	18R11AD466	ECE - 3B	7989988719	charankalyan2008@gmail.com
02	G. Kasthi Manikanta	18R11AD465	ECE - 3B	8008149705	manikartha023@gmail.com
03.	DSS. Pavan kumar	18R11AD460	ECE - 3B	8555844950	pavan.kumar15bhs@gmail.com
04.	J. Bharadwaj sharma	18R11AD468	ECE - 3B	7998545834	

Title - idea e-Farmer Portal Development

Novelty of the idea:

(Patent/market/Literature search

Grives farmers detailed information of their farmlands and suggest what crops to grow and also teach them ways to harvest and store their produce. Also, create a portal where farmers can directly interact with end consumers.

Technical Feasibility:

Since, every person (almost) has a smartphone with internet connection, this would facilitate an easy way of farming.

PRINCIPAL

Geethanjali College of Engg. Tech.  
Cheeryal (V), Keesara (M), R. Dist. (A.P.) - 501301

# Geethanjali College of Engineering and Technology

CHEERYAL (V), KEESARA (M), MedchalDIST-501301, Telangana

Suggestions/Remarks given by the Jury

Date: 12/12/2020

15

Team Number/Name:

S.No	Name	Roll Number	Branch and Year	Contact	Email id
1	TAHA RAHEEL	19R11A04C7	ECE - 2 <sup>nd</sup>	9398293715	tahaskeema786@gmail.com
2	P. SHASHI VIGNESH	19R11A04D1	ECE - 2 <sup>nd</sup>	9390432257	paritalashashi210@gmail.com
3	T. HARSHA SAI TARANG	19R11A04E0	ECE - 2 <sup>nd</sup>	7396202696	teegala.harshaisaitarang@gmail.com
4	Y. SANDHYA	19R11A04E4	ECE - 2 <sup>nd</sup>	6300324901	

Title - idea

PERSONAL HEALTH INFORMATION APP (PHI)

Novelty of the idea:

(Patent/market/Literature search)

The Personal Health Information Stores the medical data of the person in an organised manner.

Technical Feasibility:

PRINCIPAL  
Geethanjali College of Engg. Techn.  
Cheeryal (V), Keesara (M), R.R. Dist. (A.P.) - 501301



# Geethanjali College of Engineering and Technology

CHEERYAL (V), KEESARA (M), MedchalDIST-501301, Telangana

Team Number	Title	Novelty	Tech Feasibility	Marketing feasibility	Financial Viability	Scalability	social cost benefit analysis	Potential for future additions/progressions	Total	Feedback/Remarks
		(20Marks)	(10Marks)	(10Marks)	(10Marks)	(20Marks)	(20Marks)	(10Marks)	(100 M)	
6	Identification of <del>any</del> plants using their leaves.	15	6	7	8	15	15	7	73	
7	Human hand Gestures based and voice controlled video player	16	5	5	8	15	12	6	67	It should also take voice i.e bark ground
8)	IOT based Garbage collector	18	8	6	8	13	18	7	78	It should show all the Garbages status
9	organic cultivation without soil	16	6	7	8	14	14	7	72	cost may be more when compared with normal cultivation

Name of the Jury Member

Dr. K. Srinivas

Signature



# Geethanjali College of Engineering and Technology

CHEERYAL (V), KEESARA (M), MedchalDIST-501301, Telangana

Team Number	Title	Novelty	Tech Feasibility	Marketing feasibility	Financial Viability	Scalability	social cost benefit analysis	Potential for future additions/progressions	Total	Feedback/Remarks
		(20Marks)	(10Marks)	(10Marks)	(10Marks)	(20Marks)	(20Marks)	(10Marks)	(100 M)	
10	Flower <del>making</del> Knitting machine	18	8	7	9	14	15	7	78	As the flowers are delicate, holding of it is to be also considered.

Geethanjali College of Engg. Techn.  
 Cheeryal (V), Keesara (M), R. Dist. (A.P.), 501301  
**PRINCIPAL**

Name of the Jury Member

Dr. K. Sriniva

Signature





# Geethanjali College of Engineering and Technology

CHEERYAL (V), KEESARA (M), Medchal, District-501301, Telangana

## IDEATHON

Team Number	Title	Novelty	Tech Feasibility	Marketing feasibility	Financial Viability	Scalability	social cost benefit analysis	Potential for future additions/progressions	Total	Feedback
		(20Marks)	(10Marks)	(10Marks)	(10Marks)	(20Marks)	(20Marks)	(10Marks)	(100 M)	
1	Communicative System for hearing & Speech Impaired people	16	15 7.5	15 7.5	7	15	15	7		Good prototype plugin all the suggestions Scalability Two Way Group usage Wireless data / transmission Good

Name of the Jury Member

Signature

*(Signature)*

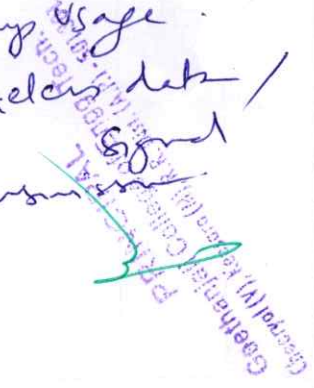

# Geethanjali College of Engineering and Technology

CHEERYAL (V), KEESARA (M), MedchalDIST-501301, Telangana

Team Number	Title	Novelty	Tech Feasibility	Marketing feasibility	Financial Viability	Scalability	social cost benefit analysis	Potential for future additions/progressions	Total	Feedback/Remarks
		(20Marks)	(10Marks)	(10Marks)	(10Marks)	(20Marks)	(20Marks)	(10Marks)	(100 M)	
2	<u>Adithi &amp; Kishore</u> <u>Know your Crop. MAPP</u>	12	7	5	5	5	10	5		not of Home Work in all the criteria to be done more two roughly

  
**PRINCIPAL**  
 Geethanjali College of Engg. Tech.  
 Cheeryal (V), Keesara (M), Dist. Medchal, Tel. 501301.

Name of the Jury Member

Signature

*P. Swathi*



# Geethanjali College of Engineering and Technology

CHEERYAL (V), KEESARA (M), MedchalDIST-501301, Telangana

## Marketing Feasibility:

As the fake news is spreading rapidly, many of them are introducing certain kind of softwares to detect them and control them. So, our project will have demand in the market.

## Financial Viability:

Free of cost as all the softwares are freely available.

## Project scalability:

It can be upgraded to an web application and also for App.

## social cost benefit analysis:

It is benefited to all users who uses the social media for updates.

## Other Remarks:

PRINCIPAL  
Geethanjali College of Engg. Tech.  
Cheeryal (V), Keesara (M), R.R. Dist. (A.P.) - 501 301

Name of the Mentor/Team Lead: V. Aishwarya

Signature: V. Aishwarya

# Geethanjali College of Engineering and Technology

CHEERYAL (V), KEESARA (M), MedchalDIST-501301, Telangana

## Marketing Feasibility:

Through playstore it will be available in the market.

## Financial Viability:

It is cost effective.

Developed using free softwares and open libraries.

## Project scalability:

Done with Back-end procedure. Can be modified into a mobile application.

## social cost benefit analysis:

Installation can be done ~~over~~ from playstore.

**Other Remarks:** Our project is ready only with initial level where emotion is recognised on CPU. Now the upgradation is to make it a interactive system feasible on mobile device too. Which would suggest playlist and quotes according to mood (emotion) detected by recognition.

Shiv Narayan sir  
Name of the Mentor/Team Lead:

Signature

  
PRINCIPAL  
Geethanjali College of Engg. Tech.  
Cheeryal (V), Keesara (M), N.R. Dist. (A.P.) - 501 301



# Geethanjali College of Engineering and Technology

CHEERYAL (V), KEESARA (M), Medchal, District-501301, Telangana

## IDEATHON

Team Number	Title	Novelty	Tech Feasibility	Marketing feasibility	Financial Viability	Scalability	social cost benefit analysis	Potential for future additions/progressions	Total	Feedback
		(20Marks)	(10Marks)	(10Marks)	(10Marks)	(20Marks)	(20Marks)	(10Marks)	(100 M)	
		5	Advanced Automated Electrical vehicle for Differently abled person.	15	8	8	8	15	18	

Geethanjali College of Engg. Tech.  
 Cheeryal (V), Keesara (M), K.R. Dist. (A.P.) - 501301.  
**PRINCIPAL**

Name of the Jury Member

Signature



# Geethanjali College of Engineering and Technology

CHEERYAL (V), KEESARA (M), MedchalDIST-501301, Telangana

## Suggestions/Remarks given by the Jury

- To be able to identify the threats with the plant (if any) Date: 12/12/2021
- To develop into an ~~app~~ dynamic application, which can be ~~used~~ used in real time world.

Team Number/Name: 6

No	Name	Roll Number	Branch and Year	Contact	Email id
1	B. Rohit	17R11A05K3	CSE - III	8309749656	rohithrugu@gmail.com
2	S. Suchith	17R11A05N6	CSE - III	9398279806	ssuchith299@gmail.com

### Title - idea

Identification of medicinal plants based on their leaves using image processing.

### Novelty of the idea:

(Patent/market/Literature search)

We plan to make it much more efficient than the existing ones. We intend to make it atleast 90% efficient.

### Technical Feasibility:

To develop a system which is capable of identifying the plant using the images of the leaf, using OpenCV. The image is identified using different features of a leaf like rectangularity, circularity, etc so that we can identify a particular set of data to identify it.

PRINCIPAL  
Geethanjali College of Engg. Techn.  
Cheeryal (V), Keesara (M), R.R. Dist. (A.I.T.E.R.) 501301



# Geethanjali College of Engineering and Technology

CHEERYAL (V), KEESARA (M), Medchal, District-501301, Telangana

## IDEATHON

Team Number	Title	Novelty	Tech Feasibility	Marketing feasibility	Financial Viability	Scalability	social cost benefit analysis	Potential for future additions/progressions	Total	Feedback
		(20Marks)	(10Marks)	(10Marks)	(10Marks)	(20Marks)	(20Marks)	(10Marks)	(100 M)	
6	Identification of Medicinal plants	15	7	7	5	15	15	6		<p>Student also has some other project idea.</p> <p>of Automated Street Light Controls.</p> <p>College electricity Bill Saving</p>

Name of the Jury Member

Signature



# Geethanjali College of Engineering and Technology

CHEERYAL (V), KEESARA (M), MedchalDIST-501301, Telangana

Suggestions/Remarks given by the Jury

Date:

Topic: - Computer commands through hand gestures, voice controller.

Team Number/Name: ~~XXXXXXXX~~ #

Jo	Name	Roll Number	Branch and Year	Contact	Email id
1	T. Rithika	17R11A0546	CSE IV-A	9000397011	rithikanaidu21@gmail.com
2	M. Veda	17R11A0521	CSE IV-A	9515353089	veda.kris.sambhitha5@gmail.com
3	Tara	17R11A0520	CSE IV-A	939812252	KsaiTara@gmail.com

Ythk  
Hsr  
VLC

Title - idea Human gestures and voice ~~control~~ based video player.   
 Computer Commands using HG, VC → [What App]

Novelty of the idea: :- It is all about making our hand while video getting played, we can operate using our hand, operations include - forwarding, backwarding, volume up and volume down. Instead of using remote control, we use our hand to operate the video. This is advance version of it,

Technical Feasibility: without our touch on the gadget or screen, we are able to do operations freely using our hand. This is more flexible than using any remote control device to operate.

PRINCIPAL  
 Geethanjali College of Engg. Tech.  
 Cheeryal (V), Keesara (M), N.R. Dist. (A.P.) - 501301



# Geethanjali College of Engineering and Technology

CHEERYAL (V), KEESARA (M), Medchal, District-501301, Telangana

## IDEATHON

Team Number	Title	Novelty	Tech Feasibility	Marketing feasibility	Financial Viability	Scalability	social cost benefit analysis	Potential for future additions/progressions	Total	Feedback
		(20Marks)	(10Marks)	(10Marks)	(10Marks)	(20Marks)	(20Marks)	(10Marks)	(100 M)	
		7	Human Gestures and Voice Control Based Computer Commands.	18	8	5	5	15	15	

Geethanjali College of Engineering and Technology, Cheeryal (V), Keesara (M), R.R. Dist. (A.P.) - 501301

PRINCIPAL

Name of the Jury Member

Signature



# Geethanjali College of Engineering and Technology

CHEERYAL (V), KEESARA (M), MedchalDIST-501301, Telangana

Suggestions/Remarks given by the Jury

Date: 12/12/20

8.

Team Number/Name:

No	Name	Roll Number	Branch and Year	Contact	Email id
1	N. Swetha	17R11A0436	ECE and III	7993822982	kalamswetha17@gmail.com
2	P. Kavya	17R11A0439	ECE and III	8639436730	ktsnanil7@gmail.com
3	P. Gopi	18R15A0410	ECE and III	9948137694	palepugopi4922251@gmail.com

Title - idea

IoT Based Garbage Monitoring and Air pollution Controlling System.

Uniqueness of the idea:

(Patent/market/Literature search)

Able to control air pollution and monitoring the garbage in various bins.

Technical Feasibility:

It is possible to implement in real time

PRINCIPAL  
Geethanjali College of Engg. Tech.  
Cheeryal (V), Keesara (M), R.R. Dist. (A.P.) - 501 301



# Geethanjali College of Engineering and Technology

CHEERYAL (V), KEESARA (M), MedchalDIST-501301, Telangana

Team Number	Title	Novelty	Tech Feasibility	Marketing feasibility	Financial Viability	Scalability	social cost benefit analysis	Potential for future additions/progressions	Total	Feedback/Remarks
		(20Marks)	(10Marks)	(10Marks)	(10Marks)	(20Marks)	(20Marks)	(10Marks)	(100 M)	
8	IoT Based Garbage Monitoring	17	8	7	7	12	15	7		lot of improvements & challenges. Enable Google map kind of bubble map Escalation system to be implemented for GHMC.

PRINCIPAL  
 Geethanjali College of Engg. Tech.  
 Cheeryal (V), Keesara (M), R.R. Dist. (A.P.) - 501301

Name of the Jury Member

Signature

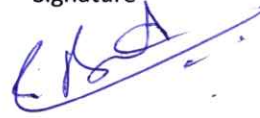

# Geethanjali College of Engineering and Technology

CHEERYAL (V), KEESARA (M), MedchalDIST-501301, Telangana

Suggestions/Remarks given by the Jury

Date:

Team Number/Name: 89

S.No	Name	Roll Number	Branch and Year	Contact	Email id
1	S.V. Raghavendra	18R11A0344	Mech - III	630929241	Sadhu Venkatesh Vaghavendra@gmail.com
2	P. Premanand	18R11A0397	Mech - III	9989923848	Premanand Pargidoju @gmail.com
3	B. Manasa	18R11A0310	Mech - III	8383020474	borramanasa @gmail.com
4	V. Poojitha	18R11A03	Mech - III	8374155549	poojithavelivale@ gmail.com

Title - idea

Hydroponics - (Static cultivation)

PRINCIPAL

Geethanjali College of Engg. Tech.  
Cheeryal (V), Keesara (M), R.R. Dist. (A.P.) - 501 301

Novelty of the idea:

(Patent/market/Literature search)

It is a way of cultivation using water and nutrients without soil. There are very few companies in India who cultivate and sell kits

Technical Feasibility:

Easy farming and gives high yield  
produces a lot more yield and different  
crops can be cultivated. The crop is given  
in very less time with equal and  
higher production rate



# Geethanjali College of Engineering and Technology

CHEERYAL (V), KEESARA (M), MedchalDIST-501301, Telangana

Suggestions/Remarks given by the Jury

Date: 12/12/20

10

Team Number/Name:

S.No	Name	Roll Number	Branch and Year	Contact	Email id
1.	(TEAM LEADER) O.SAIVARUN	19R11A0329	ME(A)-I <sup>st</sup>	6305174967	osequntav@gmail.com
2.	Ch. Srinivas	19R11A0307	ME(A)-I <sup>st</sup>	9652122947	chsrinivas80@gmail.com
3.	Sree Harsha V	19R11A04P7	ECE(E)-I <sup>st</sup>	6302935998	sreeharshaV15@gmail.com
—	—	—	—	—	—
	(TEAM MENTOR) Dr. Subhash Kamal	—	—	9948176918	subhashkamel@gmail.com

Title - idea

Flower knitting Machine (FKM)

Novelty of the idea:

(Patent/market/Literature search)

This machine design is not patented and also in market it will have unique feature to sustain and create employability and we can improve this product on further requirements.

Technical Feasibility:

We will deliver the product / machine through Online;  
(or) can purchase from a local retailer (Malls, Market  
(or) you can endorse on amazon (or) any other online website(s).

# Geethanjali College of Engineering and Technology

CHEERYAL (V), KEESARA (M), MedchalDIST-501301, Telangana

Team Number	Title	Novelty	Tech Feasibility	Marketing feasibility	Financial Viability	Scalability	social cost benefit analysis	Potential for future additions/progressions	Total	Feedback/Remarks
		(20Marks)	(10Marks)	(10Marks)	(10Marks)	(20Marks)	(20Marks)	(10Marks)	(100 M)	
10	Flower knitting Machine	18	8	8	8	18	18	8		<p style="font-size: 2em; color: green;">Excellent</p>

GEETHANJALI COLLEGE OF ENGINEERING AND TECHNOLOGY  
 CHEERYAL (V), KEESARA (M), MEDCHAL DIST - 501301, TELANGANA

Name of the Jury Member

Signature





# Geethanjali College of Engineering and Technology

CHEERYAL (V), KEESARA (M), MedchalDIST-501301, Telangana

Team Number	Title								Potential for future additions/progressions	Total (100 M)	Feedback/Remarks
		Novelty	Tech Feasibility	Marketing feasibility	Financial Viability	Scalability	social cost benefit analysis				
		(20Marks)	(10Marks)	(10Marks)	(10Marks)	(20Marks)	(20Marks)	(10Marks)			
2	Know your crop (mobile app)	10	8	6	10	15	12	5	68	 <b>PRINCIPAL</b> Geethanjali College of Engg. Techn. Cheeryal (V), Keesara (M), R.R. Dist. (A.P.) - 501301	
3.	Facial Emotion Recognition using video cam.	9	7	5	10	12	12	5	60		
4	Fake news. detection (text content)	8	5	4	10	8	8	3	46		
1	comm. system for hearing and speech impaired people.	8	6	5	10	10	12	5	56		
5.	Electric wheel chair	7	8	5	10	15	12	5	62		
6	Identification of weeds and plants using image process	7	8	5	10	15	10	5	60		
7.	Human gestures and voice control	10	8	7	10	16	15	7	73		

Name of the Jury Member

Dr. L. Venkateswarlu  
Professor in CSE

Signature

*[Handwritten Signature]*

# Geethanjali College of Engineering and Technology

CHEERYAL (V), KEESARA (M), Medchal, District-501301, Telangana

## IDEATHON

Team Number	Title	Novelty	Tech Feasibility	Marketing feasibility	Financial Viability	Scalability	social cost benefit analysis	Potential for future additions/progressions	Total	Feedback
		(20Marks)	(10Marks)	(10Marks)	(10Marks)	(20Marks)	(20Marks)	(10Marks)	(100 M)	
8	IoT based Geology Collector.	15	8	7	10	15	15	5	75	 PRINCIPAL Geethanjali College of Engineering and Technology Cheeryal (V), Keesara (M), A.R. Dist. (A.P.) - 501301
9.	organic cultivation with out soil. (Hydroponics)	12	8	5	10	14	14	5	69	
⑩	Alumna Knit machines.	14	7	5	10	12	13	5	67	

Name of the Jury Member

*Dr. L. Venkateswarar*  
 Professor in CSR

Signature

*L. Venkateswarar*



# Geethanjali College of Engineering and Technology

CHEERYAL (V), KEESARA (M), MedchalDIST-501301, Telangana

Team Number	Title	Novelty	Tech Feasibility	Marketing feasibility	Financial Viability	Scalability	social cost benefit analysis	Potential for future additions/progressions	Total	Feedback/Remarks
		(20Marks)	(10Marks)	(10Marks)	(10Marks)	(20Marks)	(20Marks)	(10Marks)	(100 M)	
2.	Know Your Crop (mobile APP)	12	8	7	8	13	12	7	67	Extend it for more no of samples (green arrow)
3.	Facial Emotion Recognition (mobile APP)	16	8	7	7	15	15	8	76	Test it in our college group. enhance it for other applications not only music. Collected with food survey etc
4.	Fake news detection using data.	10	7	6	6	8	9	4	50	Not clear about data set & parameters. Accuracy is not good. Limited to English language.

Name of the Jury Member Dr. M. Aruna Bharathi

Signature M. Sree Bharathi

# Geethanjali College of Engineering and Technology

CHEERYAL (V), KEESARA (M), MedchalDIST-501301, Telangana

Team Number	Title	Novelty	Tech Feasibility	Marketing feasibility	Financial Viability	Scalability	social cost benefit analysis	Potential for future additions/progressions	Total	Feedback/Remarks
		(20Marks)	(10Marks)	(10Marks)	(10Marks)	(20Marks)	(20Marks)	(10Marks)	(100 M)	
1.	Communication system for hearing and speech impaired ppl	15	8	8	8	17	16	8	80	work on interface, speed test it for more samples. Good project for social need.
5.	Electric wheel chair.	18	8	9	9	18	17	9	88	try for backward motion also. involve mechanical design and apply mobile app.
8.	Advanced Automated Electrical vehicle for disabled persons.									
6.	Identification of medicinal plants using image processing.	14	7	7	7	14	16	8	73	Try for other data set also other than flower dataset.

Name of the Jury Member Dr. M. Aruna Bharathi

Signature M. Aruna Bharathi

Geethanjali College of Engineering and Technology  
Cheerla (V), Keesara (M), Medchal Dist, Telangana



# Geethanjali College of Engineering and Technology

CHEERYAL (V), KEESARA (M), Medchal, District-501301, Telangana

## IDEATHON

Team Number	Title								Potential for future additions/progressions	Total (100 M)	Feedback
		Novelty	Tech Feasibility	Marketing feasibility	Financial Viability	Scalability	social cost benefit analysis				
		(20Marks)	(10Marks)	(10Marks)	(10Marks)	(20Marks)	(20Marks)	(10Marks)			
7.	Human hand Discharge & reception; voice controlled video player.	18	9	8	8	18	17	8	86	Work on command mode and alter mode (Python based)	
8.	IoT based garbage monitoring system.	16	8	8	8	16	16	8	80	work with globe map to identify every garbage point. & → use solar power.	
9.	Hydroponic	14	6	7	7	14	6	9	63	Involve egg aspects.	
10.	Flower metering machine	17	9	8	8	18	16	8	84	Try to automate model.	

PRINCIPAL  
 Geethanjali College of Eng. Tech.  
 Cheeryal (V), Keesara (M), Medchal, Dist. (A.P.) - 501301

Name of the Jury Member **DY. M. Aruna Bharathi**

Signature **M. Aruna Bharathi**

# Geethanjali College of Engineering and Technology

CHEERYAL (V), KEESARA (M), MedchalDIST-501301, Telangana

Team Number	Title	Novelty	Tech Feasibility	Marketing feasibility	Financial Viability	Scalability	social cost benefit analysis	Potential for future additions/progressions	Total	Feedback/Remarks
		(20Marks)	(10Marks)	(10Marks)	(10Marks)	(20Marks)	(20Marks)	(10Marks)	(100 M)	
2	Know your crop	18	8	6	8	13	18	7	78	Need to develop a plan to market the product
1	Facial Recognition Emotion	18	8	7	9	14	15	7	78	Need to be applied for different expressions
3	Fake News Detection	13	6	6	5	10	15	6	61	Need to be applied for different languages as well
4	Communication system for Hearing and Speech impaired people	15	5	6	6	14	15	6	70	Technical feasibility is to be improved
5	Electric wheelchair	15	8	8	8	15	18	8	80	Need to be improved in look and structure and can be used for mobile

Name of the Jury Member

Dr. K. Srinivas

Signature



PRINCIPAL  
Geethanjali College of Engg. Techn  
Keesara (M), Medchal (Dist), A.R. Dist. (A.P.) - 501301



# Geethanjali College of Engineering and Technology

CHEERYAL (V), KEESARA (M), MedchalDIST-501301, Telangana

J1015 Access

Team Number	Title	Novelty	Tech Feasibility	Marketing feasibility	Financial Viability	Scalability	social cost benefit analsis	Potential for future additions/ progressi ons	Total	Feedback/Remarks
		(20Marks)	(10Marks)	(10Marks)	(10Marks)	(20Marks)	(20Marks)	(10Marks)	(100 M)	
CSE (Rohith)	6. Identification of medicinal plants based on their leaves using Image Processing	16	8	9	10	18	18	9	88	Flavia Dataset has reference database
CSE	7. Human gesture & voice controlled Video Player									
ECE	8. IoT Based Smart garbage collector	15	8	8	8	12	18	8		
ME	9. <del>Hydroponics</del> Flower Knitting machine	17	8	8	10	15	18	9		

**PRINCIPAL**  
 Geethanjali College of Engg. Techn.  
 Cheeryal (V), Keesara (M), Dist. Medchal (A.P.) - 501301

Name of the Jury Member

*QUPRSIVAKUMAR*

Signature

# Geethanjali College of Engineering and Technology

CHEERYAL (V), KEESARA (M), MedchalDIST-501301, Telangana

Suggestions/Remarks given by the Jury

Date:

12/12/20

Team Number/Name: 5

S.No	Name	Roll Number	Branch and Year	Contact	Email id
1.	19R15A0215	M. Devika	EEE	7095395189	devika.sweetly1518@gmail.com
2.	19R15A0214	D. Swathi	EEE	8688984875	swathidamera005@gmail.com
3.	19R15A0217	B. Sugandhi	EEE	9030760004	busesugandhi11@gmail.com
4.	16R11A0213	B. Rakesh	EEE	8074518066	rakesh98365@gmail.com
5.	1617R15A0209	Chinmay	EEE	7799646430	chinmayprince456@gmail.com

Title - idea

Advanced Automated Electrical vehicle for Differentially  
Able persons.

Novelty of the idea:

(Patent/market/Literature search)

Project Complete patent In process  
Planning for Startup.

Technical Feasibility:

Already in working conditions

Components:-

Dc motor, motor driver

Battery, Software (c++)

Arduino UNO

Joy stick.

PRINCIPAL  
Geethanjali College of Engg. Tech.  
Cheeryal (V), Keesara (M), R.R. Dist. (A.P.) - 501301



# Geethanjali College of Engineering and Technology

CHEERYAL (V), KEESARA (M), MedchalDIST-501301, Telangana

## Suggestions/Remarks given by the Jury

→ Develop a plan to market the product.

Date: 12/12/2020

→ To take samples of prominent plants of a particular area for training the data sets

→ In phase 1, take samples of a few plants and try to get right outputs for max plants

→ Present the novelty of the product clearly along with financial benefits.

Team Number/Name: 2/

S.No	Name	Roll Number	Branch and Year	Contact	Email id
1	Adithi Kulkarni	17R11A0549	IV - CSE	9493462607	adithikulkarni1204@gmail.com
2	SLK Sai Kishore	17R11A0591	IV - CSE	7382077848	dubby.sai@gmail.com
3	K. Lalitha	17R11A0572	IV - CSE	.	.

Title - idea KNOW YOUR CROP MOBILE APPLICATION

To develop an application to detect the crop diseases and display the causes, symptoms and precautions to be taken to the user.

Novelty of the idea:

(Patent/market/Literature search)

Helps the farmers to detect the condition of the crop at an early stage and quickly and also enhance the quality of the crop w.r.t the weather, soil and several other conditions. Also give the precautions to be taken and also

Technical Feasibility: the solution to solve the issues.

- User friendly application.
- Inbuilt camera
- Able to upload the images from their smartphones.
- User friendly widgets.

PRINCIPAL  
Geethanjali College of Engineering and Technology  
Cheeryal (V), Keesara (M), Medchal (A.P) - 501301

# Geethanjali College of Engineering and Technology

CHEERYAL (V), KEESARA (M), MedchalDIST-501301, Telangana

**Marketing Feasibility:** It is ~~for~~ mainly used for Impaired people-  
It ~~is~~ consists of a glove.

**Financial Viability:** Around 3000 - 4000.

**Project scalability:** Impaired people who are deaf and dumb.

**social cost benefit analysis:** According to WHO <sup>are</sup> there 1 million people who  
are deaf, dumb and blind.

**Other Remarks:**

PRINCIPAL  
Geethanjali College of Engg. Tech.  
Cheeryal (V), Keesara (M), R.R. Dist. (A.P.) - 501301

Name of the Mentor/Team Lead: B. Sai Tej.

Signature









Geethanjali

Phone : 9182058187  
Website: www.geethanjaliinstitutions.com  
info@gcet.edu.in

## Geethanjali College of Engineering and Technology AUTONOMOUS

(Accredited by NAAC "A" Grade; ECE, CSE, EEE & ME, B.Tech Programs Accredited by NBA;  
Approved by AICTE, New Delhi; Permanently Affiliated to JNTUH)  
Sy. No. 33 & 34, Cheeryal (V), Keesara (M), Medchal District. - 501 301.

19<sup>th</sup> Nov 2020

The first council meeting of Institution's Innovation Council (IIC), Geethanjali College of Engineering and Technology was called by IIC President Dr. Udaya Kumar Susarla to discuss upon the formulation and function of IIC & shared roles and responsibility among newly joined council members as per the guidelines of MHRD's Innovation cell.

The council members met and discussed about the objective of IIC, type of activities (IIC calendar and Self-Driven), features of IIC portal for monthly report submission mechanism.

The council members also discussed about collaborations with organizations to accelerate the activities of IIC. The council also deliberated on quarterly action plan in synchronisation with activities and initiatives of other departments, centers and facilities in the Institute working towards promoting IPR, Innovation and Start up.

S. No.	Name of the Member	Member Type (Teaching/Non-Teaching / External Expert)	Key Role/Position assigned in IIC	Signature
1	Dr. Udaya Susarla	Principal and President	President	
2.	Dr. Anil Kumar Puppala	Faculty	Convener, Innovation Activity, NISP coordinator	
3.	Ms. Borra Manasa	Student	IPE Coordinator	An online meeting was held. A picture of the same is uploaded
4.	Mr. Harshith	Student	Member	
5.	Mr. Jaswanth	Student	IIC coordinator	
6.	Mr. Nari Vivek	Student	Incubation activity	
7.	Mr. Sai Varun	Student	IPR Activity	
8.	Ms. Sandhya	Student	IPR activity	same is uploaded
9.	Mr. Sunny Raj	Student	Incubation Activity	Absent

PRINCIPAL  
Geethanjali College of Engineering and Technology  
Cheeryal (V), Keesara (M), R.R. Dist. (A.P.) - 501 301



Sponsored by TEJA EDUCATIONAL SOCIETY, HYDERABAD  
Office : Sy. No. 33 & 34, Cheeryal (V), Keesara (M), Medchal Dist. - 501 301

Phones : 9182058196, 9182058194



**Minutes of the meeting of the IIC council at Geethanjali College of Engineering held on 19<sup>th</sup> Nov 2020**

- Convener Dr. Anil Puppala has welcomed the new members: faculty & students, inducted into the council.
- Importance of the activities that the council has to take up within the guidelines of National Innovation and startup policy (NISP) has been ascertained by the principal Dr. Uday Kumar Susarla, which would lead to improvement of the intellectual property of not only the institution but also in nation building. It also helps in ARIIA ranking and IIC star rating of the institutions.
- Dr. Rajesh Srivastava observed that the council had professors and students as members and so opined that Assistant professors across all departments have to be included. Convener will look into the possibility after checking with the Heads of individual departments.
- The role of the student members was explained by the principal. They will not only spread the word but also act as ambassadors of innovation within the campus.
- Individual responsibilities of the council members were assigned and roles were explained.

The following members were present in the online meeting

Dr. Udaya Susarla	Principal and President
Dr. Anil Kumar Puppala	Faculty
Ms. Borra Manasa	Student
Mr. Harshith	Student
Mr. Jaswanth	Student
Mr. Nari Vivek	Student
Mr. Sai Varun	Student
Ms. Sandhya	Student
Mr. Sunny Raj	Student
Mr. Tarun	Student
Mr. Udith	Student
Mr. OVPR Siva Kumar	Faculty
Dr. Ramakanta Mohanty	Faculty
Dr. Harsha Praneeth	Faculty
Dr. Rajesh Srivasthava	Faculty
Dr. Spandana	Faculty

PROVINCIAL  
Geethanjali College of Engg. Techn.  
Cheeryal (V), Keesara (M), R.R. Dist. (A.P.) - 501 3



# Geethanjali College of Engineering and Technology

CHEERYAL (V), KEESARA (M), Medchal DIST-501301, Telangana

Report

Of the MIC- driven activity

National Webinar on

11<sup>th</sup> Aug 2020

Research, Innovation, and Ranking

as part of the one-year celebration of National Education Policy 2020  
(NEP 2020).

**Objective:** To strive for a better ranking for our Geethanjali College of Engineering and Technology. Data submission and work in teams stands key to the research and innovation.

**Outcome:** The inputs of some of the panelists viz.,

Dr. K.K. Agarwal – Chairman of NBA board of accreditation

Dr. V. RamaGopal Rao – IIT Delhi

Dr. Raj Kumar

Dr. Ashwin Fernandes

Dr. Radha Krishna - ISRO

Mr. Yash Raj Bharadwaj

Mr. Deepak Bagla

IISc Bangalore – Funding support

Were very well received by the faculty at GCET. GCET's team working on NIRF and ARIIA ranking had a fruitful discussion on the strategy that GCET has to follow so that it could be placed well in the ranking.

Geethanjali College of Engg. Tech.  
Cheeryal (V), Keesara (M), K.R. Dist. (A.P.) - 501 301



# Gallery



The inputs of some of the panelists viz.,

Principal  
 Kasturba College of Engg. Tech.  
 (Gwalior (V), Amravati (M), R.R. Dist (A.P)) 2019-2021

*(Handwritten signature)*



24 FF

GEETHANJALI COLLEGE OF ENGINEERING AND TECHNOLOGY  
Cheeryal (V), Keesara (M), Medchal Dist. – 501301

---

No. GCET/ 113 /2020-21

12.02.2021

**OFFICE OF THE PRINCIPAL**

**CIRCULAR**

Freshman Engineering department and Centre for Soft Skills Development is organizing a Three Day Workshop as per the following details.

- Dates : From February 28<sup>th</sup>, 2021 to 2<sup>nd</sup> March, 2021.  
(Sunday to Tuesday)
- Time : 9.00am to 5.30 pm
- Target Audience : Selected students from 1<sup>st</sup> year B.Tech.
- Venue : AECS –ICS Labs (Block-1)
- Topic : **“Design Thinking and Critical Thinking”**
- Resource Person : Dr. Bala Ramadurai- an author, coach, consultant, Adjunct Professor at Symbiosis Institute of Business Management, Professor at National Programme on Technology Enhanced Learning(NPTEL), Visiting Professor, IIT Gandhinagar, IISC Bangalore.
- Convener : Dr. G. Neeraja Rani, Professor and HoD-FE
- Coordinators : Dr. B. Nagamani-Associate Professor of English  
Mrs. V. Manjula-Assistant Professor of Physics

  
PRINCIPAL

To: Deans / HODs  
AO/Website Coordinator

  
PRINCIPAL  
Geethanjali College of Engg. and Tech.  
Cheeryal (V), Keesara (M), Medchal Dist.(T.S.)-501 301.





maha laxmi &lt;gmaha98@gmail.com&gt;

## Fwd: Thank you

4 messages

**talented kids Balantrapu** <bnsreekar28@gmail.com>  
To: maha laxmi <gmaha98@gmail.com>

Fri, Mar 12, 2021 at 12:21 AM

Print please

----- Forwarded message -----

From: **talented kids Balantrapu** <bnsreekar28@gmail.com>  
Date: Tue, Mar 2, 2021 at 7:21 PM  
Subject: Thank you  
To: Bala Ramadurai <bala@balaramadurai.net>

Greetings from Geethanjali College of Engineering and Technology!

On behalf of the Management, Principal, Head of the Department, and on my own behalf, I thank you profoundly for accepting our invitation and providing great learning opportunity for our students.

It's not a surprise that several Thank You messages popped on our What's app group and private messages posted to us.

Sir please find your account details and confirm.

Name of the Account Holder: Balachandar Ramadurai

Bank Name: HDFC Bank

Account Number: 50200008824321

Address of Bank and Branch: HDFC Bank, Raturang, 49-1 Pune-Satara Road, Aranyeshwar Corner, Sahakar Nagar, Pune.

IFSC: HDFC0000359

PAN: AAKPB4758L

Thank you

Dr.B.Nagamani

**talented kids Balantrapu** <bnsreekar28@gmail.com>  
To: maha laxmi <gmaha98@gmail.com>

Fri, Mar 12, 2021 at 12:21 AM

Print please

----- Forwarded message -----

From: **Bala Ramadurai** <bala@balaramadurai.net>  
Date: Wed, Mar 3, 2021 at 2:54 PM  
Subject: Re: Thank you  
To: talented kids Balantrapu <bnsreekar28@gmail.com>

Dear Madam,

Thank you so much for your help in arranging the workshop. I am aware that such a workshop of such scale requires many people - Principal Sir, other faculty, staff and of course, our students. I thank each one of them for their support.

On another note, yes, the account details are correct.

Thanks and have a nice day!

Bala

**KARMIC  
DESIGN THINKING**



**Bala Ramadurai** Author, Professor and Consultant

bala@balaramadurai.net

+91 99750 57144

<https://dt.balaramadurai.net>

**PRINCIPAL**  
Geethanjali College of Engg. and Tech.  
Cheeryal (V), Keesara (M), Medchal Dist.(T.S.)-501 301.

Geethanjali College of Engineering and Technology  
UGC Autonomous  
Centre for Soft Skills Development, Department of Freshman Engineering  
Report on A Three Day Workshop on Design Thinking and Critical Thinking  
28-02-2021 to 2-03-2021

**Pre Workshop:**

The idea of conducting a workshop to provide hands on experience to the students started on Jan 7<sup>th</sup>, 2021. The resource person was identified and after seeking the necessary approval from the college authorities, the dates of the workshop were fixed keeping in mind the availability of the resource person and our academic calendar.

Then after a series of discussions with the resource person over phone, we felt that providing self learning material to the students before attending the workshop will be advantageous, as the students can spend more time in working during the three days of workshop.

Later, 100 students were selected based on their enthusiasm to work on projects Principal and HoD, addressed all the selected students on 5<sup>th</sup> February, 2021 through an online meet from 6.15 p.m to 6.45 p.m.

Multidisciplinary teams consisting of 5 members in a team were formed and they were informed to browse various problem statements available on AICTE, UGC and other MNC websites. In addition, they were also advised to observe meticulously for identifying new problem statements.

The resource person, Dr.Bala Ramadurai, Professor at NPTEL, SIBM Pune shared 16 Youtube videos and three assignments for the students. To make this happen, the students were asked to join the Google Meet from 16<sup>th</sup> February to 20<sup>th</sup>, 2021 from 6.30 p.m to 7.45 p.m.

Students were given a week's time to discuss and identify problem statements. Teams 1 to 10 presented their problem statements on 22<sup>nd</sup> February, teams 11 to 20 presented their problem statements on 23<sup>rd</sup> February from 6.00 p.m to 8.30 p.m.

**During the workshop:**

All the students actively and enthusiastically participated in the workshop. The pre-learning sessions helped them to understand the concepts easily and facilitated more time to work on their problem statements and more time and opportunity to interact with the resource person. On the last day of the workshop many teams have either completed doing a website or half way through an app or made a prototype.

Mr. Santosh of Mechanical Engineering Department who was identified from the department has extended a lot of support and cooperation.

  
PRINCIPAL  
Geethanjali College of Engg. and Tech.  
Cheeryal (V), Keesara (M), Medchal Dist.(T.S.)-501 301



### Post Workshop:

After the Semester end examinations, students should be motivated to complete the projects they have taken up or select another problem statement. Weekly progress of the work has to be monitored. In case, the students ask for any help in emerging technologies, mentors should be identified to support the students.

### Outcomes of the workshop:

Team 18-Techie Tribes Blending gaming and academics. Worked on the app taking Physics concept.

Team 3: Suggested the students to start working on the app (TOME- A very large book)

Team 15: Prototype was made based on their problem statement.

We thank the Management and Principal for granting permission for conducting this workshop. Our thanks are due to the convener of the workshop Dr.G.Neeraja Rani, HoD- Freshman Engineering and Convener of the workshop for being a constant support and for her valuable pieces of advice in planning and executing.

Feedback: On the last day of the workshop an online feedback was taken. Majority of the students gave either 4 or 5 for the resource person's passion and enthusiasm in dealing with the concepts. Almost all the students agreed that real time examples were given. Participants agreed that the resource person delivered the content clearly. **For the question, After attending the workshop, I learnt..... sample responses are given below:**

- A lot and I increased my ability to work with team
- How to work in a team and what design thinking is
- This workshop was very insightful and made absolute sense in terms of the problem statement their s application. I am thankful for having the opportunity to attend.”
- Questions are important than solutions to it
- How to solve problems , time management , working with many people
- How to be a Design Thinker and Work on a Project
- How to solve problems using Triz analysis
- How to interact with new people around me and to work as a team, and to solve some basic problems
- How to innovate ideas.
- Time management, to not over think, team spirit and adjusting in the environment.
- How to think differently
- How to empathize ,analyse,solve and test a problem
- I learnt how to approach a problem and solve it. I also learnt how to work in a team .
- What all steps to be followed before trying to create an app
- How to solve a problem
- Awareness on different problems faced all over.
- I wish to have this kind of workshops more and more

  
PRINCIPAL  
Geethanjali College of Engg. and Tech.  
Cheerla (V), Keesara (M), Medchal Dist.(T.S.)-501 301.

For the last question on any suggestions.....sample responses are given below:

- Nothing...but I was disappointed that we meet sir through virtual meeting...
- If it was a direct meet in the work shop it would be more nice
- No . Everything was good .
- It was an amazing workshop. Only problem : conducted during exam time.
- Improvement of intercom and wifi
- Need as much help as possible from faculty to develop our project
- Session was mind blowing
- Every inch was perfect but, offline would have been more fun.

Coordinator(s)

Dr.B.Nagamani-Associate Professor of English

Ms.V.Manjula- Assistant Professor of Physics

P.S: Photographs are added in the next page.

  
PRINCIPAL  
Geethanjali College of Engg. and Tech.  
Cheeryal (V), Keesara (M), Medchal Dist.(T.S.)-501 301.



## Glimpses of the Workshop



Steering committee with the resource person.



Engineers in the make- engrossed in work.



Posing for a photo.



Faculty interacting with the students.

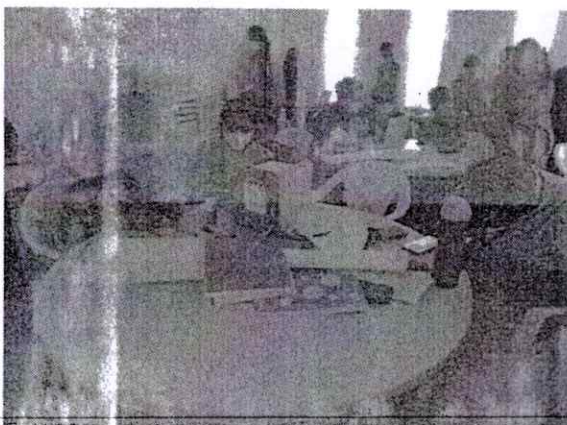

Building a prototype.



Learning while doing.



PRINCIPAL

Geethanjali College of Engg. and Tech.  
Cheerai (V), Keesara (M), Medchal Dist. (T.S.)-501 301.



As busy as bees.



Teams at work

  
**PRINCIPAL**  
Geethanjali College of Engg. and Tech.  
Cheeryal (V), Keesara (M), Medchal Dist.(T.S.)-501 301.





# Geethanjali College of Engineering and Technology

(UGC Autonomous)

(Accredited by NAAC with 'A' Grade & NBA, Approved by AICTE and Permanently Affiliated to JNTUH)  
Cheeryal(V), Keesara(M), Medchal Dist., Telangana State – 501 301.

## Report of

### A webinar on “Innovations & Entrepreneurship among students community”

#### 1. Need Analysis

Currently, higher education plays an important role in developing *Innovations & entrepreneurship* among students. As this is an additional requirement of 21<sup>st</sup> century students, academicians must understand its importance to guide them in that direction. Considering this as a part of curriculum teachers must involve and lead the students to develop their skills towards innovation and entrepreneurship. Based on the above, there is a need to understand the importance of Innovations & Entrepreneurship among students community. Hence, a webinar session is planned by Institute's Innovation Council of Geethanjali College of Engineering and Technology in the month of March 2021.

#### 2. Details of the webinar:

**Title:** *How to Manifest Innovation & Entrepreneurship Ecosystem in the Student Community and Protection of IP for Innovations*

**Date:** 26-03-2021 (Friday)

**Time:** 2:00 PM to 3:30 PM

**Google Meet link:** <https://meet.google.com/ava-yjsz-trf>

**Resource Person:** Dr. M. K. Kaushik, CEO-VIBA (Vaagdevi Incubation and Business Accelerator)

**No. of Participants:** 103

**Target Audience:** Participants from different departments joined the webinar session

#### The speaker focused on the following topics:

- Discussed about the innovations in India and the position of India in global ranking w.r.t. innovations and start-ups
- Discussed about aspiration of Indian innovations by 2024

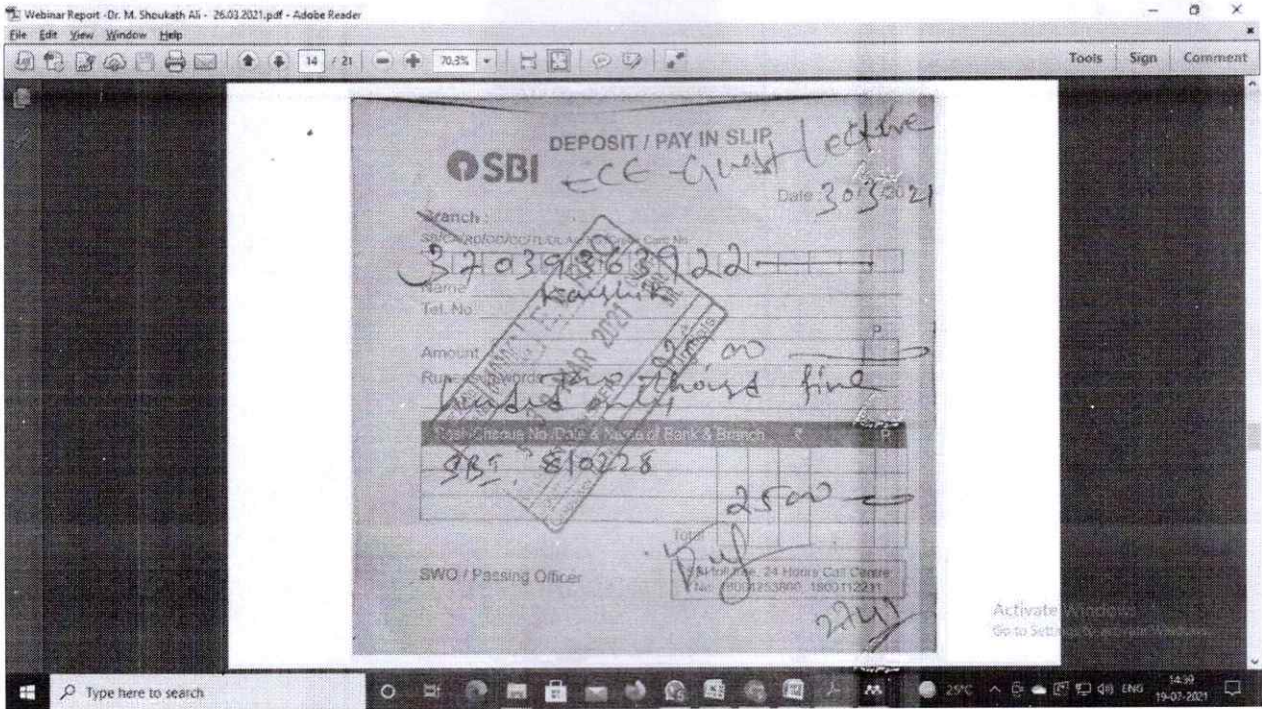

### 3. Invitation Brochure

**A Webinar on**

**“How to Manifest Innovation & Entrepreneurship  
Ecosystem in the Student Community and  
Protection of IP for Innovations”.**



**Speaker:**  
**Dr. M. K. Kaushik**  
CEO-VIBA

Date: 26-03-2021 & Time: 2:00 PM to 3:30 PM

Link: <https://meet.google.com/ava-yjsz-trf>

**Department of Electronics & Communication Engineering**  
**Geethanjali College of Engineering and Technology**

Accredited by NAAC with 'A' Grade & NBA. Approved by AICTE and Affiliated to JNTU/H  
Cheerlyal(V), Keesara(M), Medchal Dist., TS - 501 301.

### 4. Photos



**PRINCIPAL**  
**Geethanjali College of Engg. and Tech.**  
**Cheerlyal (V), Keesara (M), Medchal Dist.(T.S.)-501 301.**



1	ogirala.sivakumar@gmail.com	Mr.	OVPR Sivakumar	GCET
2	pvijaibhaskar@gmail.com	Dr.	P.Vijai Bhaskar	GCET
3	boddusuneetha1710@gmail.com	Mrs.	B. Suneetha	Geethanjali College of Engineering and Technology
4	sathyavemuri@gmail.com	Dr.	Satya srinivas Vemuri	Geethanjali college of Engineering and technology
5	vallisree.ece@gcet.edu.in	Dr.	S.Vallisree	Geethanjali College of Engineering and Technology
6	jyothi.ece@gcet.edu.in	Mrs.	S. Jyothirmaye	Geethanjali College of Engineering and Technology
7	dvrreddy1@gmail.com	Mr.	D Venkata Rami Reddy	GCET
8	harikumar.ece@gcet.edu.in	Mr.	HARI KUMAR BUDHAVARAPU	Geethanjali College of Engineering and Technology
9	aadharisanthosh.me@gcet.edu.in	Mr.	AADHARI SANTHOSH	GEETHANJALI COLLEGE OF ENGINEERING AND TECHNOLOGY HYDERABAD
10	rsudarshan.me@gcet.edu.in	Mr.	Rikka Sudarshan	Geethanjali College of Engineering and Technology, Hyderabad
11	laxmireddyperam.me@gcet.edu.in	Mr.	Peram Laxmireddy	Geethanjali College of Engineering and Technology
12	bhaskerb9.me@gcet.edu.in	Mr.	Bhasker.Bommera	Geethanjali College of Engineering and Technology, Hyd.
13	shainaz.mba@gcet.edu.in	Mrs.	Mrs.SHAINAZ BEGUM	Geethanjali college of engineering and technology
14	apsjyothi.mba@gcet.edu.in	Mrs.	Parvathi Siva Jyothi Bhogadi	Geethanjali College of Engineering and Technology
15	satyamech343@gcet.edu.in	Mr.	P Satyanarayana	GCET Hyderabad
16	kvenkatesh.me@gcet.edu.in	Mr.	KOLUSU VENKATESH	Geethanjali College of Engineering and Technology

  
**PRINCIPAL**  
 Geethanjali College of Engg. and Tech.  
 Cheeryal (V), Keesara (M), Medchal Dist.(T.S.)-501 301.

33	kshashanka.mba@gcet.edu.in	Mrs.	k shashanka	Geethanjali College of Engineering Technology
34	katkamsrinu@gmail.com	Dr.	Srinivas Katakam	Geethanjali College of Engineering and Technology
35	sprcbtech07@gmail.com	Mr.	S POORNA CHANDER RAO	GEETHANJALI COLLEGE OF ENGINEERING AND TECHNOLOGY
36	mbahod71@gmail.com	Dr.	J. Pardha Saradhi	Geethanjali College of Engineering and Technology
37	vittam.raki2@gmail.com	Mr.	Vittam Rakesh	Geethanjali College of Engineering and Technology Cheeryal keesara Medchal Hyderabad
38	hasinifromasia@gmail.com	Mrs.	Naga Suhasini V.	Geethanjali college of Engineering and Technology
39	masadiprashanth@gmail.com	Mr.	M. PRASHANTH KUMAR	Geethanjali college of engineering and technology(Autonomous)
40	banitha.me@gcet.edu.in	Mrs.	B. Anitha	Geethanjali college of Engineering and Technology
41	drshoukathali.ece@gcet.edu.in	Dr.	M. Shoukath Ali	Geethanjali College of Engineering and Technology
42	surasapthagiri.me@gcet.edu.in	Dr.	Sura Sapthagiri	Geethanjali College of Engineering and Technology
43	ravikanth.mba@gcet.edu.in	Mr.	Ravikanth Thogarcheti	Geethanjali College of Engineering and Technology
44	umarani.ece@gcet.edu.in	Mrs.	M.UMARANI	Geethanjali College of Engineering and Technology
45	gopagonipraveen@gmail.com	Mr.	PRAVEENKUMAR GOPAGONI	Geethanjali College of Engineering and Technology
46	sitamadhavi.mba@gcet.edu.in	Dr.	A Sita Madhavi	Geethanjali College of Engineering and Technology
47	annedachandrakala@gmail.com	Mrs.	A.chandrakala	Geethanjali college of engineering and technology

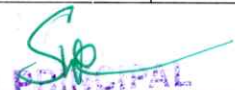
  
**PRINCIPAL**  
 Geethanjali College of Engg. and Tech.  
 Cheeryal (V), Keesara (M), Medchal Dist.(T.S.)-501 301.



64	anushareddy.kallem@gmail.com	Mrs.	K.Anusha	GEETHANJALI COLLEGE OF ENGINEERING AND TECHNOLOGY
65	monika.cse@gcet.edu.in	Mrs.	A MONIKA	Geethanjali college of engineering and technology
66	naupal.mba@gmail.com	Mr.	Mr.K.Naupal Reddy	Geethanjali College of Engineering and Technology
67	murali.krr@gmail.com	Mr.	Murali karri	Geethanjali college of engineering and technology
68	gumadevi.cse@gcet.edu.in	Mrs.	G. Uma Devi	Geethanjali college of engineering and technology
69	naresh.kosuri@gmail.com	Mr.	Kosuri naresh babu	Geethanjali college of engineering and technology
70	santoshkumar.cse@gcet.edu.in	Mr.	Santhosh Kumar	Geethanjali college of engineering and technology UGC-AUTONOMOUS Hyderabad
71	gumadevi.cse@gcet.edu.in	Mrs.	G Uma Devi	Geethanjali College of engineering and technology
72	rajesh5479.cse@gcet.edu.in	Dr.	Rajesh Kumar Shrivastava	Geethanjali College of Engineering and Technology, Hyderabad
73	mkeerthi.cse@gcet.edu.in	Ms.	KEERTHI MANCHIKANTI	Geethanjali College Of Engineering and Technology
74	narrirajendar.me@gcet.edu.in	Mr.	N Rajendar	Geethanjali college of engg and Tech
75	kunchala324@gmail.com	Mr.	K RAJU	GCET
76	lavanyamaguluri@gmail.com	Mrs.	Lavanya Maguluri	Geethanjali college of engineering and technology
77	rajmohan_st@yahoo.com	Mr.	S T Rajmohan	Geethanjali College of Engineering & Technology
78	upendermaloth@gmail.com	Dr.	Maloth Upender	Geethanjali College of Engineering and Technology
79	neerajarani@gmail.com	Dr.	Gaddipati Neeraja Rani	Geethanjali College of Engineering and Technology

**PRINCIPAL**  
 Geethanjali College of Engg. and Tech.  
 Cheeryal (V), Keesara (M), Medchal Dist.(T.S.)-501 301.

				technology
96	suresh.ece@gcet.edu.in	Mr.	Ch Suresh Kumar	Geethanjali college of engineering and technology
97	manjulavijayagiri@gmail.com	Mrs.	V Manjula	Geethanjali College of Engineering and Technology
98	nemani.subhadra@gmail.com	Dr.	NEMANI SUBADRA	Geethanjali College of Engineering and Technology
99	bnsreekar28@gmail.com	Dr.	Nagamani Balantrapu	Geethanjali College of Engineering and Technology
100	blprakash.ece@gcet.edu.in	Dr.	B.L.Prakash	Geethanjali College of Engg and Technology
101	kniranjankumar.me@gcet.edu.in	Mr.	KATIKANI NIRANJAN KUMAR	GEETHANJALI COLLEGE OF ENGINEERING AND TECHNOLOGY
102	swathibacharaju.cse@gcet.edu.in	Dr.	B. V. Swathi	Geethanjali college of Engineering and Technology
103	spandana.ece@gcet.edu.in	Dr.	P. Spandana	Geethanjali college of Engineering and Technology

  
**PRINCIPAL**  
 Geethanjali College of Engg. and Tech.  
 Cheeryal (V), Keasara (M), Medchal Dist.(T.S.)-501 301.





# Geethanjali College of Engineering and Technology

CHEERYAL (V), KEESARA (M), Medchal DIST-501301, Telangana

## Report on

Session on: Why IP is important in Academia?

26<sup>th</sup> April 2021

(MIC driven activity)

As Geethanjali College of Engineering and technology and all other colleges in Telangana were under lockdown, information about this was passed on to students and faculty. Several faculty took the session at their convenient time on different days from their home/office and sent us the pictures. Also, after the college has opened, it was ensured that the same is played/disseminated in the classroom as well.

**Objective:** Number of IPs that were filed from the college stands at a very dismal number. Hence to improve the same, IP literacy/awareness session was telecasted and taken to students and faculty.

**Outcome:** A lot of awareness about intellectual property was born/created among the student community.

They expressed wonder about the IP born in the campuses across the Globe and the quality of the companies that were born in the campus.

Total number of students: 270

Faculty attended till date: 13

Some of the pictures of our faculty/students who listened to the lecture

PRINCIPAL  
Geethanjali College of Engg. and Tech.  
Cheeryal (V), Keesara (M), Medchal Dist.(T.S.)-501 301.



Dr. Neeraja CSE  
Dept

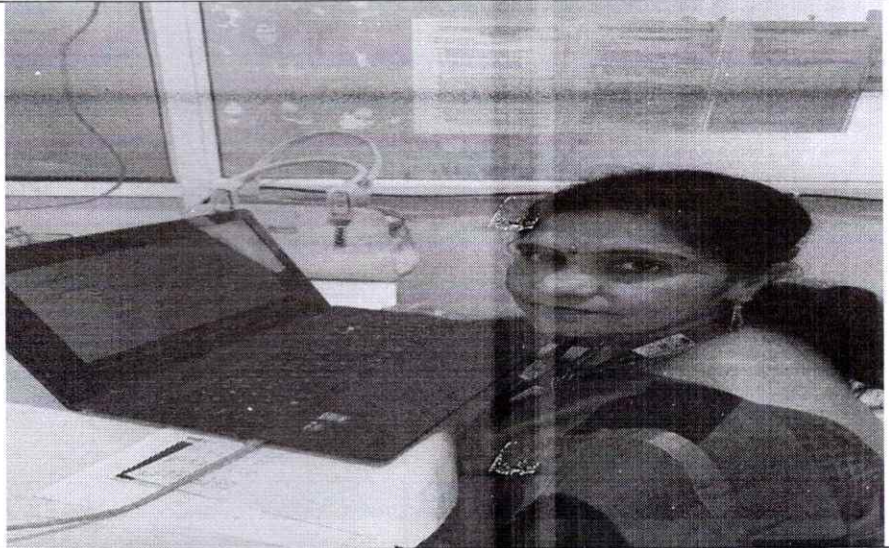

Dr. S. ValliSree, IIC  
Member and Prof  
ECE Dept

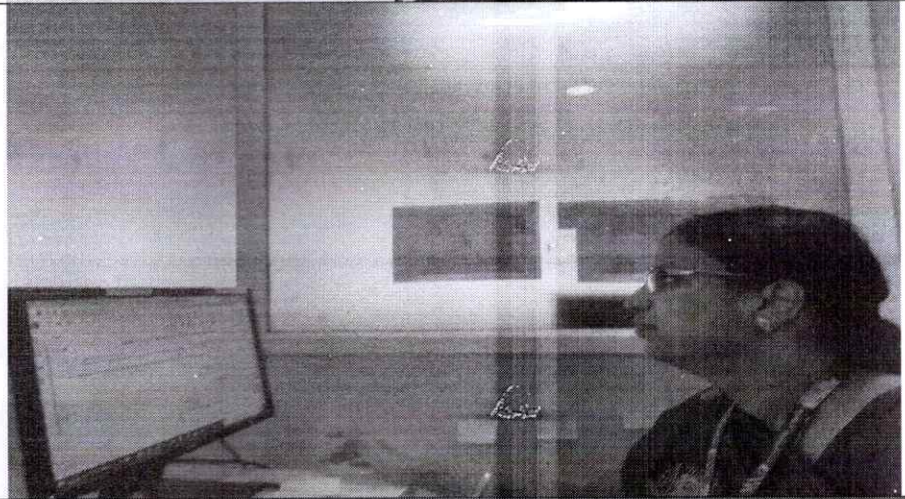

Some students

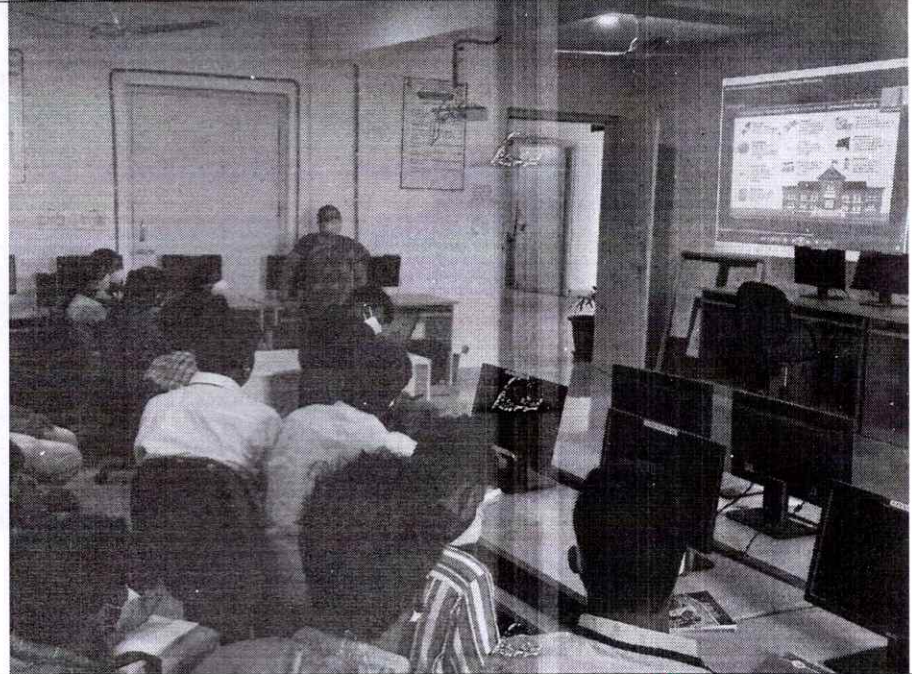





## Report of

### National webinar on “Intellectual Property Rights – Drafting and Claims”

Organizer: Geethanjali College of Engineering and Technology, Hyderabad.

Date Organized: 20<sup>th</sup> Oct 2020

Number of Students benefitted: 95

Faculty attended: 16

Link of the recording:

<https://drive.google.com/file/d/1kZUzAIA6kvSEXYAI26b0WA4uzzmEgKNK/view?usp=sharing>

#### Resource Person:

Dr. Siva Shankar. Holder of India Book of Records – For “Maximum patents filed in the year” 2019

About the Resource Person

#### Dr.Siva Shankar S

Is a Ph.D. in CSE, with his B.Tech and M.Tech in the same disciplines.

S.No	Designation	University / Industry	Duration	
			From	To
1.	Lecturer	PSNCET,Tirunelveli	07/2006	07/2007
2.	Assistant Professor	IJCE,Tuticorin	06/2009	06/2011
3.	Software Engineer	Aggrim Technologies	07/2011	11/2012
4.	Assistant Professor	NCERC,Thrissur	01/2013	12/2015
5.	Assistant Professor	ASET,Palakad	12/2015	07/2018
6.	Associate Professor	KL University, Vijayawada	31/07/18	04/2019
7.	HOD/Associate Professor	KG Reddy College of Engineering and Technology, Hyderabad	05/2019	Present

  
Geethanjali College of Engg. and Tech.  
Cheeryal (V), Keesara (M), Medchal Dist.(T.S.)-501 301.



VideoRecording.mp4 - VLC media player  
Media Playback Audio Video Subtitle Tools View Help

 **Geethanjali College of Engineering and Technology**  
**PRESENTS**  
**National Webinar :**  
**"Intellectual Property Rights – Drafting and Claims"**  
**Resource Person :**  
**Dr. Siva Shankar**  
Holder of India Book of Records For "Maximum patents filed in the year" 2019  
**Date: 20th Oct 2020**  
**Time: 11:00 AM to 1:00 PM**  
**No Registration Fee.**  
**Registration Link:**  
<https://forms.gle/3T7F5Vg4G7SgkKc6B>

 **HUB**

[https://geethanjali.edu/engg/our-courses](#) [http://www.geethanjali.edu](#)



00:00 3:06:47  
Show desktop 9:54 AM 2/10/2021





  
**PRINCIPAL**  
**Geethanjali College of Engg. and Tech.**  
**Cheerla (V), Keesara (M), Medchal Dist.(T.S.)-501 301.**

M (no subject) - apuppala@...
M Inbox (21) - apuppala@g...
Meet - wms-uuwc-dri
Introduction to IPR, draft

[meet.google.com/wms-uuwc-dri](https://meet.google.com/wms-uuwc-dri)
12:00 PM

**REC**
SivaShankar Subramanian is presenting
P HARITHA GCET and 27 more

**THE SECOND SCHEDULE**  
(See rule 6)  
**FORMS**  
**LIST OF FORMS**

Form No.	Section and rule	Title
1.	Sections 7, 5a and 135 and rule 20(1).	Application for grant of a patent.
2.	Section 10, rule 13.	Provisional/Complete Specification.
3.	Section 8 and rule 12.	Statement and undertaking.
4.	Sections 53(2) and 142(4), rules 13(6), 24B(4)(b), 40(1A) and 130.	Request for extension of time.
5.	Section 10(6) and rule 13(6).	Declaration as to inventorship.
6.	Sections 20(1), 26(4), 20(5) and rules 34(1), 35(1) or 36(1).	Claim or request regarding any change in applicant for patent.
7.	Section 25(3) and rule 55A.	Notice of opposition on grant of a patent.
7A.	Section 25(1) and rule 55(1)	For filing a representation opposing grant of a patent under sub-section (1) of section 25.
8.	Sections 28(2), 28(3) or 28(7) and rules 66, 67, 68.	Request or claim regarding invention of inventor as such in a patent.
9.	Section 11A(2) and rule 23A.	Request for publication.
10.	Section 44 and rule 25.	Application for amendment of patent.
11.	Sections 51(1), 51(2) and rules 76, 77.	Application for direction of the Controller.
12.	Sections 26(1) & 52(2) and rules 65A and 79.	Request for grant of patent.
13.	Section 57 and rule 81(1).	Application for amendment of the application for patent/complete specification.

meet.google.com is sharing your screen. [Stop sharing](#) [View](#)



SivaShankar



RS Raju



Dr. ARUNA B.



PREETI PRAS.



Prema Akkas



Rakesh Kurma

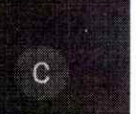

19R11A05N4

12:00 PM  
10/20/2020

  
**PRINCIPAL**  
 Geethanjali College of Engg. and Tech.  
 Cheralai (V), Keasara (M), Medchal Dist. (T.S.)-501 301.



M Inbox (1,645) - apuppala@ X M Inbox (21) - apuppala@g X Meet - wms-uuwc-dri X Introduction to IPR, draft X +

meet.google.com/wms-uuwc-dri

REC SivaShankar Subramanian is presenting Dr.Saladi Saritha and 24 more 234 12:13 PM You

- Any subjective words like *"thin"*, *"strong"*, *"a major part"*, *"such as"*, *"when required"* or *"any"* should be avoided.
- A claim usually consists of three parts :
  1. Preamble or Introductory phrase
  2. Transitional Phrase
  3. Body of the claim
- Ex: "A tool for opening metal containers, the tool comprising a spindle split throughout its length....."

meet.google.com is sharing your screen Stop sharing

SivaShankar RS Raju Dr. ARUNA B... PREETI PRAS... Prema Akkas... Rakesh Kurma... 19R11A05N4...

12:13 PM 10/20/2020

Siva

PRINCIPAL  
Geethanjali College of Engg. and Tech.  
Cheerla (V), Keesara (M), Medchal Dist.(T.S.)-501 301.





Geethanjali

Phone : 9182058187  
Website : www.geethanjalinstitutions.com  
info@gcet.edu.in

## Geethanjali College of Engineering and Technology AUTONOMOUS

(Accredited by NAAC "A" Grade; ECE, CSE, EEE & ME, B.Tech Programs Accredited by NBA;  
Approved by AICTE, New Delhi; Permanently Affiliated to JNTUH)  
Sy. No. 33 & 34, Cheeryal (V), Keesara (M), Medchal District. - 501 301.

20<sup>th</sup> Oct 2020

### Letter of Appreciation.

This is to acknowledge and appreciate the talk delivered by Dr. Siva Shankar S. on "Intellectual property Rights – documentation and Claims" using virtual a tool (Google Meet). The participants included students and faculty from Geethanjali college of Engineering and Technology and also from other colleges.

I/C Incubation Center,

Dr. Anil Kumar Puppala

Principal,

**PRINCIPAL**

Geethanjali College of Engg. and Tech.  
Cheeryal (V), Keesara (M), Medchal Dist.(T.S.)-501 301.

Dr. Udaya Kumar Susarla

Sponsored by **TEJA EDUCATIONAL SOCIETY, HYDERABAD**

Office : Sy. No. 33 & 34, Cheeryal (V), Keesara (M), Medchal Dist. - 501 301.

Phones : 9182058196, 9182058194

Geethanjali College of Engg. and Tech.  
Cheeryal (V), Keesara (M), Medchal Dist.(T.S.)-501 301.



## Report of the webinar on

### National Innovation and Start-up Policy

Resource Person: Dr. Kaushik CEO, Vagdevi Incubation and business Accelerator

Date: 18<sup>th</sup> Jan 2021

No. Of Students: 210

No. of Faculty: 8

The video is available at for any one to view at a later time

<https://drive.google.com/file/d/1Zer4RpeWxJqyZzjPSiFlfbnijAtL0Co1/view?usp=sharing>

Geethanjali College of Engineering and Technology, Hyderabad  
Career and Academic Guidance Cell



Webinar on

# “ National Innovation and Start-up Policy ”

By  
Dr. Kaushik, CEO Vaagdevi Incubation and business Accelerator  
18 Jan 2021, 2pm

PS: Google meet link  
<https://meet.google.com/nve-wdtk-yfa>



*Siva*  
Geethanjali College of Engg. and Tech.  
Cheerla (V), Keesara (M), Medchal Dist.(T.S.)-501 301.

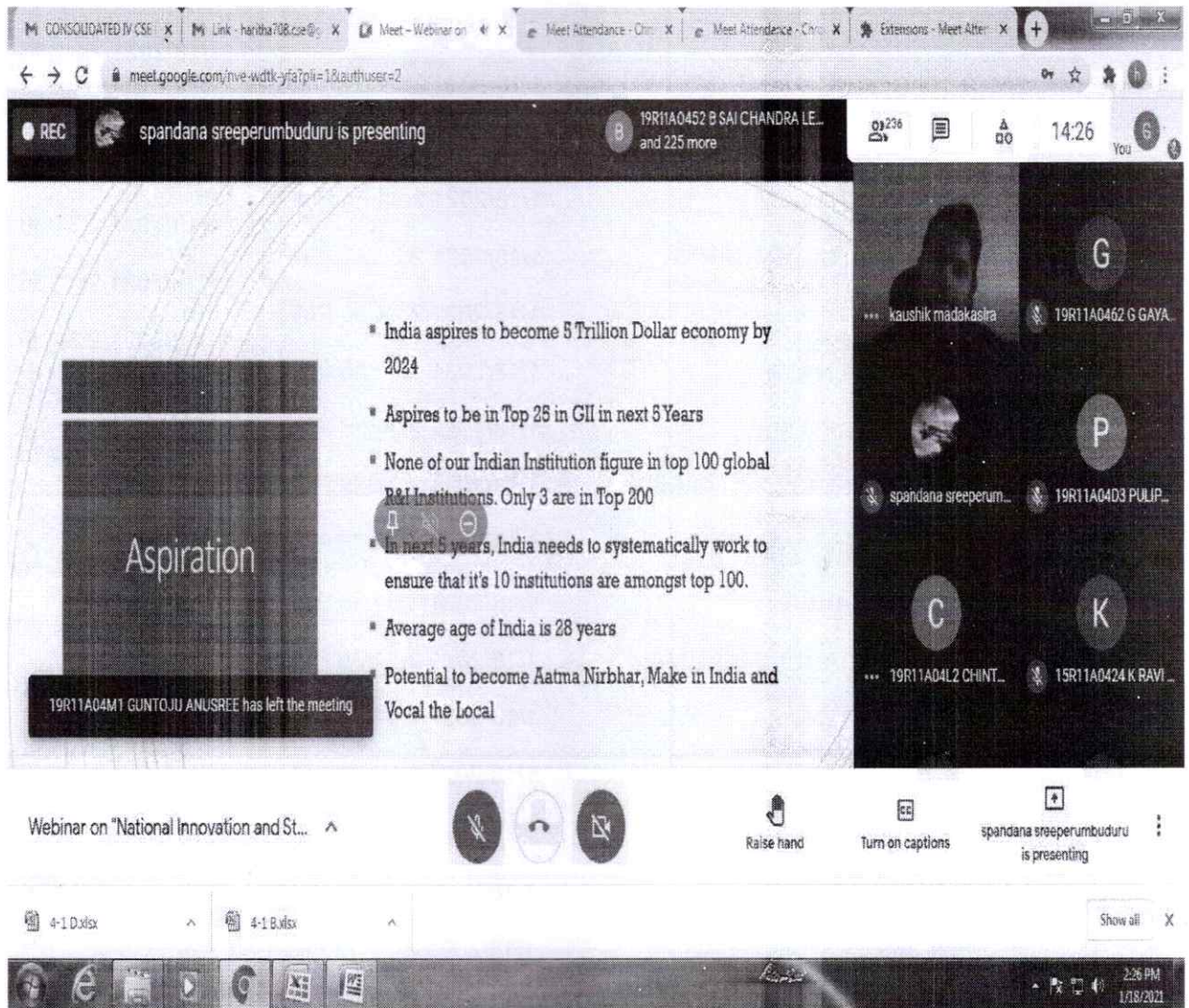

## Attendance:

Participants	Joined	Left
Geethanjali College Engineering and Technology	1/18/2021 2:34:35 PM	1/18/2021 2:34:36 PM
15R11A0424 K RAVI TEJA	1/18/2021 2:34:35 PM	1/18/2021 2:34:36 PM
16R11A0240 P NAVEEN KUMAR	1/18/2021 2:34:35 PM	1/18/2021 2:34:36 PM
17R-349 ANITHA	1/18/2021 2:34:35 PM	1/18/2021 2:34:36 PM
17R11A0276 KALAM BINDU	1/18/2021 2:34:35 PM	1/18/2021 2:34:36 PM
17R11A0277 KANNEGULLA SAI LIKHITHA	1/18/2021 2:34:35 PM	1/18/2021 2:34:36 PM

  
**PRINCIPAL**  
 Geethanjali College of Engg. and Tech  
 Chercyal (V), Keesara (M), Medchal Dist.(T.S.)-501 361



17R11A0496 VALLABHU HIMA VIVEKA	1/18/2021 2:34:35 PM	1/18/2021 2:34:36 PM
17R11A0503 BOKKA DEEPTHI	1/18/2021 2:34:35 PM	1/18/2021 2:34:36 PM
17R11A0508 DARAVATH RAJESH	1/18/2021 2:34:35 PM	1/18/2021 2:34:36 PM
17R11A0512 GOUSPUR SHIVA SAI	1/18/2021 2:34:35 PM	1/18/2021 2:34:36 PM
17R11A0513 GUBBA VASAVI	1/18/2021 2:34:35 PM	1/18/2021 2:34:36 PM
17R11A0515 HANUMANTHU SAI SINDHU	1/18/2021 2:34:35 PM	1/18/2021 2:34:36 PM
17R11A0598 AISHWARYA CHALLA	1/18/2021 2:34:35 PM	1/18/2021 2:34:36 PM
17R11A0599 AKELLA N S V L TEJASWINI	1/18/2021 2:34:35 PM	1/18/2021 2:34:36 PM
17R11A05A2 AVVARU SRAVANTH VISHNU	1/18/2021 2:34:35 PM	1/18/2021 2:34:36 PM
17R11A05A5 CHEEMAKURTHI LAKSHMI KAVYA	1/18/2021 2:34:35 PM	1/18/2021 2:34:36 PM
17R11A05A8 DUBBAKA SRI VATHSALA	1/18/2021 2:34:35 PM	1/18/2021 2:34:36 PM
17R11A05B1 GIRISH ALLAM	1/18/2021 2:34:35 PM	1/18/2021 2:34:36 PM
17R11A05B9 KOLA PRANATHI	1/18/2021 2:34:35 PM	1/18/2021 2:34:36 PM
17R11A05C5 MEDA VINAY KUMAR	1/18/2021 2:34:35 PM	1/18/2021 2:34:36 PM
17R11A05D5 TANDULE SAITEJA RAO	1/18/2021 2:34:35 PM	1/18/2021 2:34:36 PM
17R11A05D8 THOTLA ANUSHA YADAV	1/18/2021 2:34:35 PM	1/18/2021 2:34:36 PM
17R11A05E2 VANGETI AISHWARYA	1/18/2021 2:34:35 PM	1/18/2021 2:34:36 PM
17R11A05E4 YAMSANI RACHNA	1/18/2021 2:34:35 PM	1/18/2021 2:34:36 PM
18R11A0215 D SHRUTHI	1/18/2021 2:34:35 PM	1/18/2021 2:34:36 PM
18R11A0223 GOPARAPU MANIKANTA	1/18/2021 2:34:35 PM	1/18/2021 2:34:36 PM
18R11A0238 MUDIGONDA SAI KARTHIK	1/18/2021 2:34:35 PM	1/18/2021 2:34:36 PM
18R11A0251 V BHAGYASRI	1/18/2021 2:34:35 PM	1/18/2021 2:34:36 PM
18R11A0285 MADASTU RAVINDAR	1/18/2021 2:34:35 PM	1/18/2021 2:34:36 PM
18R11A04E8 B T T SUBRAMANYA SAI	1/18/2021 2:34:35 PM	1/18/2021 2:34:36 PM
18R11A04F3 CHERUKURI SAI NITHEESHA	1/18/2021 2:34:35 PM	1/18/2021 2:34:36 PM
18R11A04F7 DAKKA MANASA	1/18/2021 2:34:35 PM	1/18/2021 2:34:36 PM
18R11A04G4 GURUGUBELLI SUMA	1/18/2021 2:34:35 PM	1/18/2021 2:34:36 PM
18R11A04G5 JADHAV PALLAVI	1/18/2021 2:34:35 PM	1/18/2021 2:34:36 PM



PRINCIPAL

Geethanjali College of Engg. and Tech.  
Cheeryal (V), Keesara (M), Medchal Dist.(T.S.)-501 301.

18R15A0411 TARRA SAI GANESH	1/18/2021 2:34:35 PM	1/18/2021 2:34:36 PM
18R15A0414 MANGINIPALLY PRASAD	1/18/2021 2:34:35 PM	1/18/2021 2:34:36 PM
18R15A0503 VEMULA SOWJANYA	1/18/2021 2:34:35 PM	1/18/2021 2:34:36 PM
19R11A0343 ARJUN SUKESH	1/18/2021 2:34:35 PM	1/18/2021 2:34:36 PM
19R11A0351 ELAGAPALLY SAHAS YADAV	1/18/2021 2:34:35 PM	1/18/2021 2:34:36 PM
19R11A0358 JAVVADHI NIKHIL RAJ	1/18/2021 2:34:35 PM	1/18/2021 2:34:36 PM
19R11A0366 MORAMPUDI SATYANANDAM	1/18/2021 2:34:35 PM	1/18/2021 2:34:36 PM
19R11A0369 NIKHIL KUMAR MANDAL	1/18/2021 2:34:35 PM	1/18/2021 2:34:36 PM
19R11A0370 P SRIMANNARAYANA	1/18/2021 2:34:35 PM	1/18/2021 2:34:36 PM
19R11A0374 SOMA SHEKHAR	1/18/2021 2:34:35 PM	1/18/2021 2:34:36 PM
19R11A0379 VAPPANGI UMESH JAYACHAND	1/18/2021 2:34:35 PM	1/18/2021 2:34:36 PM
19R11A0452 B SAI CHANDRA LEKHA	1/18/2021 2:34:35 PM	1/18/2021 2:34:36 PM
19R11A0453.BAYYA RACHANA	1/18/2021 2:34:35 PM	1/18/2021 2:34:36 PM
19R11A0456 C HEMALATHA	1/18/2021 2:34:35 PM	1/18/2021 2:34:36 PM
19R11A0457 CHAMAKURA	1/18/2021 2:34:35 PM	1/18/2021 2:34:36 PM
SHUSHANTHKUMAR REDDY	1/18/2021 2:34:35 PM	1/18/2021 2:34:36 PM
19R11A0458 CHEPURI LAVANYA	1/18/2021 2:34:35 PM	1/18/2021 2:34:36 PM
19R11A0460 CHAVARTHI SWETHA SREE	1/18/2021 2:34:35 PM	1/18/2021 2:34:36 PM
19R11A0462 G GAYATHRI	1/18/2021 2:34:35 PM	1/18/2021 2:34:36 PM
19R11A0463 G SRI VIDYA	1/18/2021 2:34:35 PM	1/18/2021 2:34:36 PM
19R11A0464 GADUPUDI AMRUTHA SAI	1/18/2021 2:34:35 PM	1/18/2021 2:34:36 PM
19R11A0466 GOTTIMUKKULA HARINI	1/18/2021 2:34:35 PM	1/18/2021 2:34:36 PM
19R11A0467 HEMANT KATTA	1/18/2021 2:34:35 PM	1/18/2021 2:34:36 PM
19R11A0469 K AKASH	1/18/2021 2:34:35 PM	1/18/2021 2:34:36 PM
19R11A0471 KAKARAPU PAVAN PRATHIEK	1/18/2021 2:34:35 PM	1/18/2021 2:34:36 PM
19R11A0473 KAMPATI NAITHIKA SREE	1/18/2021 2:34:35 PM	1/18/2021 2:34:36 PM
19R11A0474 KWOKUTLA JYOSHNA	1/18/2021 2:34:35 PM	1/18/2021 2:34:36 PM
19R11A0475 LAGGANI SANDEEP	1/18/2021 2:34:35 PM	1/18/2021 2:34:36 PM
19R11A0477 MALLELA AKHILA	1/18/2021 2:34:35 PM	1/18/2021 2:34:36 PM



19R11A04D8 SHRUTI SINGH	1/18/2021 2:34:35 PM	1/18/2021 2:34:36 PM
19R11A04D9 SIDDANTH CHANDRA UDUTHA	1/18/2021 2:34:35 PM	1/18/2021 2:34:36 PM
19R11A04E0 TEEGALA HARSHA SAI TARANG	1/18/2021 2:34:35 PM	1/18/2021 2:34:36 PM
19R11A04E1 THOORPU SAHAJA	1/18/2021 2:34:35 PM	1/18/2021 2:34:36 PM
19R11A04E4 YENIMIREDDY SANDHYA	1/18/2021 2:34:35 PM	1/18/2021 2:34:36 PM
19R11A04E5 BAKI REDDYGARI MADHAVI	1/18/2021 2:34:35 PM	1/18/2021 2:34:36 PM
19R11A04E6 BATHINI HARINI	1/18/2021 2:34:35 PM	1/18/2021 2:34:36 PM
19R11A04E7 BEERAM ANKITHA MANISRI	1/18/2021 2:34:35 PM	1/18/2021 2:34:36 PM
19R11A04F1 CHENNA SURYA VAMSHI	1/18/2021 2:34:35 PM	1/18/2021 2:34:36 PM
19R11A04F2 CHILUKURI SRUTHI	1/18/2021 2:34:35 PM	1/18/2021 2:34:36 PM
19R11A04F3 CHINTAGUNTA PHANEENDRA	1/18/2021 2:34:35 PM	1/18/2021 2:34:36 PM
19R11A04F4 DASARI RAJESH REDDY	1/18/2021 2:34:35 PM	1/18/2021 2:34:36 PM
19R11A04F5 DAVA ABHINAYA	1/18/2021 2:34:35 PM	1/18/2021 2:34:36 PM
19R11A04F8 GADDAM VARDHAN	1/18/2021 2:34:35 PM	1/18/2021 2:34:36 PM
19R11A04G2 HARSHA VARDHAN SAI KARNA	1/18/2021 2:34:35 PM	1/18/2021 2:34:36 PM
19R11A04G3 INTURI ASHRITHA	1/18/2021 2:34:35 PM	1/18/2021 2:34:36 PM
19R11A04G5 K ABHINAV	1/18/2021 2:34:35 PM	1/18/2021 2:34:36 PM
19R11A04G7 KANUGANATI PRANEETH VARMA	1/18/2021 2:34:35 PM	1/18/2021 2:34:36 PM
19R11A04H3 MUDDULURU VASUDEVA RAJU	1/18/2021 2:34:35 PM	1/18/2021 2:34:36 PM
19R11A04H5 NAAGAPURI PRANAY	1/18/2021 2:34:35 PM	1/18/2021 2:34:36 PM
19R11A04H7 PULGAM SREE HARSHA	1/18/2021 2:34:35 PM	1/18/2021 2:34:36 PM
19R11A04H9 PITTALA SRUTHI	1/18/2021 2:34:35 PM	1/18/2021 2:34:36 PM
19R11A04J0 POLUPALLI PRANEETH KUMAR	1/18/2021 2:34:35 PM	1/18/2021 2:34:36 PM
19R11A04J1 POOSA KATHYAYANI	1/18/2021 2:34:35 PM	1/18/2021 2:34:36 PM
19R11A04J2 RASAKONDA PRERNA	1/18/2021 2:34:35 PM	1/18/2021 2:34:36 PM
19R11A04J5 SHAIK SAMEENA YASMEEN	1/18/2021 2:34:35 PM	1/18/2021 2:34:36 PM
19R11A04J6 SOMIREDDY BHAVANI PRASAD	1/18/2021 2:34:35 PM	1/18/2021 2:34:36 PM
19R11A04J7 TANNIRU SRAVANI	1/18/2021 2:34:35 PM	1/18/2021 2:34:36 PM

  
**PRINCIPAL**  
 Geethanjali College of Engg. and Tech.  
 Cheeryal (V), Keusara (M), Medchal Dist.(T.S.)-501 301.

19R11A0519 KORAPOLU SRIYA	1/18/2021 2:34:35 PM	1/18/2021 2:34:36 PM
19R11A0524 MAPATI BHANU SRI	1/18/2021 2:34:35 PM	1/18/2021 2:34:36 PM
19R11A0526 MEHAKAR MAHESH	1/18/2021 2:34:35 PM	1/18/2021 2:34:36 PM
19R11A0528 NUNE SAI ANIKETH	1/18/2021 2:34:35 PM	1/18/2021 2:34:36 PM
19R11A0529 PAMMI SESHU MANASA	1/18/2021 2:34:35 PM	1/18/2021 2:34:36 PM
19R11A0530 PEESARI DILEEP REDDY	1/18/2021 2:34:35 PM	1/18/2021 2:34:36 PM
19R11A0535 SAMBARI MANIKANTA	1/18/2021 2:34:35 PM	1/18/2021 2:34:36 PM
19R11A0541 V ARUN VALLIAPPAN	1/18/2021 2:34:35 PM	1/18/2021 2:34:36 PM
19R11A0542 V JEESHITHA	1/18/2021 2:34:35 PM	1/18/2021 2:34:36 PM
19R11A0546 VARKUTI DINESH REDDY	1/18/2021 2:34:35 PM	1/18/2021 2:34:36 PM
19R11A0547 VATTURI PARITOSH	1/18/2021 2:34:35 PM	1/18/2021 2:34:36 PM
19R11A0548 VUDHANTHI NEERAJA	1/18/2021 2:34:35 PM	1/18/2021 2:34:36 PM
19R11A05K7 BATTU S SHRADDHA PRIYA	1/18/2021 2:34:35 PM	1/18/2021 2:34:36 PM
19R15A0421 KADAKANCHI SAI RAM	1/18/2021 2:34:35 PM	1/18/2021 2:34:36 PM
20R15A0322 Mr. GURRALA SAI KIRAN REDDY	1/18/2021 2:34:35 PM	1/18/2021 2:34:36 PM
20R15A0324 Mr. KOMMU RAKESH KUMAR	1/18/2021 2:34:35 PM	1/18/2021 2:34:36 PM
20R15A0330 KURUMOJU SHIVA GANESH	1/18/2021 2:34:35 PM	1/18/2021 2:34:36 PM
20R15A0409 Mr. VELIDANDI AKHIL	1/18/2021 2:34:35 PM	1/18/2021 2:34:36 PM
20R15A0411 Mr. ARMULLA NIKHIL	1/18/2021 2:34:35 PM	1/18/2021 2:34:36 PM
20R15A0413 Mr. PONNAM R CHAITANYA	1/18/2021 2:34:35 PM	1/18/2021 2:34:36 PM
20R15A0414 Mr. RAMCHETTY SAMANTH RAJ	1/18/2021 2:34:35 PM	1/18/2021 2:34:36 PM
20R15A0415 Mr. VINALA VINAY KUMAR	1/18/2021 2:34:35 PM	1/18/2021 2:34:36 PM
20R15A0416 Miss CHENNAGALLA NAVYA SREE	1/18/2021 2:34:35 PM	1/18/2021 2:34:36 PM
20R15A0417 Miss RAMAGIRI VAISHNAVI	1/18/2021 2:34:35 PM	1/18/2021 2:34:36 PM
20R15A0418 Mr. KOKKALAKONDA VINAY	1/18/2021 2:34:35 PM	1/18/2021 2:34:36 PM
20R15A0419 Mr. MOHAMMED ADHIL	1/18/2021 2:34:35 PM	1/18/2021 2:34:36 PM
20R15A0420 Mr. NANDIRAJU VISHNU	1/18/2021 2:34:35 PM	1/18/2021 2:34:36 PM
20R15A0421 Miss AKULA SHRAVANI	1/18/2021 2:34:35 PM	1/18/2021 2:34:36 PM

  
**PRINCIPAL**  
 Geethanjali College of Engg. and Tech.  
 Cheeryal (V), Keesara (M), Medchal Dist.(T.S.)-501 301.



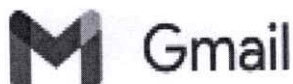

SAI KISHORE VURAKARANAM GCET &lt;vsaikishore.mba@gcet.edu.in&gt;

**Thanks for an excellent Webinar on Feb 12, 2021**

3 messages

SAI KISHORE VURAKARANAM GCET &lt;vsaikishore.mba@gcet.edu.in&gt;

Sun, Feb 14, 2021 at 8:44 PM

To: sravan &lt;gsra1kumar@gmail.com&gt;

Cc: mbahod71@gmail.com, blprakash.ece@gcet.edu.in

Dear Sir,

Greetings.

Geethanjali College of Engineering and Technology, Hyderabad, wholeheartedly appreciate your efforts in delivering an excellent webinar (Demystifying IPR) for our faculty members and students on Feb 12, 2021.

It gives us immense pleasure to share with you that, the response and the feedback was overwhelming. Many of the participants appreciated the ease by which you could reach the different levels of audience. Some of them have expressed their interest in attending similar programs from you, in future with more time duration.

There were about 135-140 participants for the webinar, which included faculty members and students. We believe that the webinar ignited the special interest among the participants towards Intellectual Property Rights.

We look forward to more programs on IPR from you in the near future.

Thanks and Regards

Sai Kishore V.  
Associate Professor  
IQAC - DMS - Department Coordinator  
GCET, Hyderabad.

sravan &lt;gsra1kumar@gmail.com&gt;

Sun, Feb 14, 2021 at 9:13 PM

To: SAI KISHORE VURAKARANAM GCET &lt;vsaikishore.mba@gcet.edu.in&gt;

Cc: mbahod71@gmail.com, blprakash.ece@gcet.edu.in

Thank you, Mr. Sai Kishore.

Good to hear about the feedback. I will look forward for more such programs in future.

Warm Regards,  
Sravan Kumar

  
PRINCIPAL  
Geethanjali College of Engg. and Tech.  
Cheeryal (V), Keesara (M), Medchal Dist.(T.S.)-501 301.

On Sun, 14 Feb, 2021, 20:44 SAI KISHORE VURAKARANAM GCET, &lt;vsaikishore.mba@gcet.edu.in&gt; wrote:

Dear Sir,

Greetings.

Geethanjali College of Engineering and Technology, Hyderabad, wholeheartedly appreciate your efforts in delivering an excellent webinar (Demystifying IPR) for our faculty members and students on Feb 12, 2021.

It gives us immense pleasure to share with you that, the response and the feedback was overwhelming. Many of the participants appreciated the ease by which you could reach the different levels of audience. Some of them have expressed their interest in attending similar programs from you, in future with more time duration.

There were about 135-140 participants for the webinar, which included faculty members and students. We believe that the webinar ignited the special interest among the participants towards Intellectual Property Rights.

We look forward to more programs on IPR from you in the near future.

Thanks and Regards

Sai Kishore V.  
Associate Professor  
IQAC - DMS - Department Coordinator  
GCET, Hyderabad.

---

**SAI KISHORE VURAKARANAM GCET** <vsaikishore.mba@gcet.edu.in>  
To: iqacgcet@gcet.edu.in

Mon, Feb 15, 2021 at 9:49 AM

For your reference !

----- Forwarded message -----

From: **SAI KISHORE VURAKARANAM GCET** <vsaikishore.mba@gcet.edu.in>  
Date: Sun, Feb 14, 2021 at 8:44 PM  
Subject: Thanks for an excellent Webinar on Feb 12, 2021  
To: sravan <gsra1kumar@gmail.com>  
Cc: <mbahod71@gmail.com>, <blprakash.ece@gcet.edu.in>

Dear Sir,

Greetings.

Geethanjali College of Engineering and Technology, Hyderabad, wholeheartedly appreciate your efforts in delivering an excellent webinar (Demystifying IPR) for our faculty members and students on Feb 12, 2021.

It gives us immense pleasure to share with you that, the response and the feedback was overwhelming. Many of the participants appreciated the ease by which you could reach the different levels of audience. Some of them have expressed their interest in attending similar programs from you, in future with more time duration.

There were about 135-140 participants for the webinar, which included faculty members and students. We believe that the webinar ignited the special interest among the participants towards Intellectual Property Rights.

We look forward to more programs on IPR from you in the near future.

Thanks and Regards

Sai Kishore V.  
Associate Professor  
IQAC - DMS - Department Coordinator  
GCET, Hyderabad.

**PRINCIPAL**  
Geethanjali College of Engg. and Tech.  
Cheeryal (V), Keosara (M), Medchal Dist.(T.S.)-501 301.



MBA Guest Honorarium

Counter foil



State Bank of India

Branch Cheer

Date 10/2/2021

Received

From 64323

By cheque No. 64323

Transfer for RTGS

On .....

Bank ADFC

Branch Mainkunder

favouring Sankar Kumar

Account

A/c No. 00751050137719

IFSC Code ADFC0003611

Amount ₹ 2500.00

Bank's

Charges ₹ 2.36

Total ₹ 2502.36

(Rupees .....

.....

Only  
*[Signature]*

*[Signature]*  
Geethanjali College of Engg. and Tech.  
Cheerjal (V), Keesara (M), Medchal Dist. (T.S.)-501 301.



To

Dt:09-Feb-2021

The Principal  
GCET, Hyderabad

Respected Sir,

Sub: Sanctioning of the honourarium & request for creating google meet link with e-certificate through server room -- Reg.

With reference to the proposal letter dated 02-Feb-2021 by the college IQAC coordinator, we have finalised the date for the webinar on awareness program on IPR titled "Demystifying IPR" on 12-Feb-2021, between 7 pm to 8.15 pm through Google meet. In this connection, we request you to direct our college server room incharge to provide us with Google meet link which can accommodate upto 200 people and generate e-certificate which could be linked to online feedback form. We further request you to sanction the amount of Rs.2500/- as honourarium for the resource person. We are attaching the approved application for your reference.

Please do the needful:

Yours sincerely,

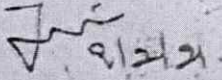
  
(Dr.J.Pardha Saradhi)  
Head of the Department - MBA  
GCET

*Handwritten notes:*  
To A/c  
9/10/21  
on page 3

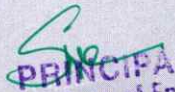
  
**PRINCIPAL**  
Geethanjali College of Engg. and Tech.  
Cheeryal (V), Keesara (M), Medchal Dist.(T.S.)-501 301.



To

Dt:02-02-2021

The Principal  
GCET, Hyderabad.

Respected Sir,

**Sub:** Proposal to conduct Webinar on IPR in the month of Feb. 2021 from IQAC - Req.

This is to bring to your kind notice that we need to organize a seminar/workshop on Intellectual Property Rights as per NAAC guidelines (B.3.3.1 in AQAR). In view of this the IQAC would like to organize a webinar on "Intellectual Property Rights" in collaboration with Department of Management Studies in February 2021. We shall be using our college Google Meet application for this webinar.

Hence, we request you to kindly approve the same, so that we can speak to the Resource person for mutually convenient date.

Thanking you Sir,

*Dr. B. Leelaram Prakash*  
Coordinator - IQAC

(Dr. B. Leelaram Prakash)

*OK*

*OK*

PRINCIPAL

Geethanjali College of Engg. and Tech.  
Cheerla (V), Keesara (M), Medchal Dist.(T.S.)-501 301.

12

GEETHANJALI COLLEGE OF ENGINEERING AND TECHNOLOGY  
Cheeryal (V), Keesara (M), Medchal Dist. - 501301

---

No. GCET/11/2020-21

11.02.2021

OFFICE OF THE PRINCIPAL

CIRCULAR

Webinar on IPR awareness for staff and students is scheduled as per the details given below.

Date : 12.02.2021 (Friday)  
Time : 7.00pm to 8.15 pm through Google meet (online)  
Venue : Online  
Topic : "Demystifying IPR"  
Resource Person : Mr.G.Sravan Kumar, Patent Attorney  
Coordinator : Dr.B.L.Prakash - Professor - IQAC Coordinator  
Dr.L.Pardhasarnidhi - Professors - HoD - MBA Dept  
Mr.V.Sai Kishore - Assoc.Prof. - MBA Dept.

  
PRINCIPAL

To: Deans / HODs  
AO/Website Coordinator

  
PRINCIPAL  
Geethanjali College of Engg. and Tech.  
Cheeryal (V), Keesara (M), Medchal Dist.(T.S.)-501 301.





**GEETHANJALI COLLEGE OF ENGINEERING AND TECHNOLOGY(Autonomous)**

**CHEERYAL(V) KEESARA(M) MEDCHAL(D).TELANGANA 501301**

**IQAC Cell /DEPARTMENT OF MANAGEMENT STUDIES**

**Webinar on Awareness program on IPR**

**"Demystifying IPR"**

**By Mr.G.Sravan Kumar, Patent Attorney**

**On 12-Feb-2021**

<b>Programme Schedule</b>	
7.00 pm – 7.02 pm	Welcoming the guest and audience by Mr.Sai Kishore V.
7.02pm -7.05 pm	Introduction about the webinar by Dr.Prakash Leelaram
7.05pm – 7.10am	Introduction about the speaker by Mrs.Lavanya
7.10pm -8.00 pm	Presentation by the speaker Mr.Sravan Kumar
8.00 pm – 8.10 pm	Q & A session
8.10pm -8.13pm	Summary by Mrs.B.P.S.Jyothi
8.13pm- 8.15pm	Vote of thanks by Dr.J.Pardha Saradhi (HoD)

*By Prakash, 12/2/2021*

IQAC coordinator.

*J. 12/2/2021*  
MBA – HOD.

**PRINCIPAL**  
Geethanjali College of Engg. and Tech.  
Cheeryal (V), Keesara (M), Medchal Dist.(T.S.)-501 301.



GEETHANJALI COLLEGE OF ENGINEERING AND TECHNOLOGY(Autonomous)

DEPARTMENT OF MANAGEMENT STUDIES

## Webinar on IPR "Demystifying IPR"

By Mr.G.Sravan Kumar, on 12-Feb-2021

### Report

IQAC in collaboration with Department of Management Studies organised a webinar titled "Demystifying IPR" on 12<sup>th</sup> February 2021 for faculty members and students of GCET. Resource person for the webinar was Mr.G.Sravan Kumar, Patent Attorney and Consultant.

Webinar started at 7 pm as per the schedule on google meet platform. Head of the Department -MBA, Dr.J.Pardha Saradhi and the webinar coordinator Mr.Sai Kishore V., welcomed the guest, faculty members and students. IQAC coordinator Dr.B.Leelaram Prakash had highlighted the importance of the topic for the webinar. Mrs.Lavanya had introduced the speaker to the audience.

Mr.Sravan Kumar, the resource person for the webinar started his presentation with the introduction and growing importance of Intellectual Property Rights. He further elaborated on power of IPR, Trade marks, Trade secrets and Copy rights. He had given an overview of Indian patent offices and its locations. He explained about different types of patent applications and its timelines.

Participants actively involved in the webinar with their queries during Q&A session and appreciated the presentation. Overall feedback given by the participants was excellent.

There were around 136 participants in the webinar, including faculty members (42) and the students (94).

Webinar ended with a summary by Mrs.B.P.S.Jyothi followed by vote of thanks by Dr.B.Leeram Prakash, IQAC coordinator.

Prepared by

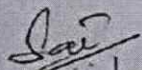

Mr.Sai Kishore V.

Webinar coordinator

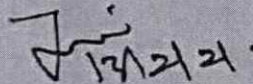

Dr.J.Pardha Saradhi

HoD-MBA

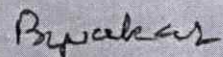

Dr.Leelaram Prakash

IQAC Coordinator

Geethanjali College of Engg. and Tech.  
Kessara (M), Medchal Dist.(T.S.)-501 301.



Attendance bot: dev(Pavan:p2pdops@gmail.com) on 2021-02-12 : 19:59: <https://meet.google.com/nsv-uenw>

Members present : 136

Geethanjali College Engineering and Technology

17-4H2 M.Nikhita

17R11A05M5 PATEL VAGGMIC REDDY

18R11A0388 MATTA SRI SHIVA SAI GANESH

18R11A0526 MAMILLA RAMYA

18R11A0555 BODDU SURESH KUMAR

18R11A0560 CHINNAM ROSE MARY

18R11A0561 D SWEKRUTHI

18R11A0567 G SAI KEERTHANA

18R11A0578 MANDA SAI JAHNAVI

18R11A0581 MOHAMMED AFREEN

18R11A0582 MOHAMMED NAZEER AHMED

18R11A0583 MOTHE SAHITHI

18R11A0584 MOVVA MANASWINI

18R11A05E8 BATHRAJ HARINI

18R11A05F4 CHINTAMANENI MEGHANA

18R11A05F6 DINTYALA NAVYA SREE

18R11A05G1 GARUGULA VIDYA SAGAR

18R11A05G2 GATTU BHARGAVI

18R11A05G9 KORUKOPPULA SAI KRISHNA

18R11A05H4 NEELAYAVALASA MEGHNA PATNAIK

18R11A05J0 SALLA ANUSHA

18R11A05J5 TADEPALLI SAI NANDINI

18R11A05J6 THARA REKHA KAKARAPARTHI

18R11A05K2 YALALA SHALINI

18R11A05K4 B VAGDEVI SAHASRA

18R11A05K5 BASIREDDY SAI NITIN REDDY

18R11A05K6 BATCHU OBED EMMANUEL

18R11A05K7 BHUKYA SAGAR

18R11A05K9 CHAKKA VYDEHI

18R11A05L0 CHALLA DHRAVITHA

18R11A05L4 DARISE GOPI CHANDU

18R11A05L5 GURRAM VISHNU SAHITA

18R11A05M0 JOSHNITHA RANGOLU

18R11A05M1 KAMMA DIVYA SREE

18R11A05M2 KANDIKONDA SHIVANI

18R11A05M4 KOYYADA ANUSHA GOUD

18R11A05M7 MALLADI VENKATA VAISHNAVI

18R11A05M9 MURUGAN RAJAM MEGHNA

18R11A05N0 PALVAI VARSHINI

18R11A05N2 PINNAMARAJU NAGA SHIVANI

18R11A05N5 RAVIKANTI VARSHA

18R11A05N7 SARAYU RANGU

**PRINCIPAL**  
Geethanjali College of Engg. and Tech.  
Cheerai (V), Keesara (M), Medchal Dist.(T.S.)-501 301.

18R11A05N8 SRIRAM VENKATA SAI SHRAVAN  
18R11A05N9 SUDAGANI SANJANA  
18R11A05P0 SUDHESHNA JINNA  
18R11A05P1 TANDA AKSHAY KUMAR  
18R11A05P2 TANMAYI KASTHURI  
18R11A05P3 THIGULLA PAVAN KUMAR  
18R11A05P4 V VAISHNAVI  
18R11A05P5 VENGALA SETTI AVINASH  
18R11A05P7 YELLELA V HARSHA VARDHAN  
18R11A05Q0 MALLARAPU PAVAN ABHINAV  
19R11A0531 POLISETTY ANDREW BALA ABHILASH  
19R11A0590 SAMMETA ASHOK KUMAR  
19R11A1208 CH SANJANA  
19R11A1219 KAREMPUDI NISHANTH  
19R11A1221 KAVDAPU GOVTHAM  
19R11A1236 P TANISHA  
19R11A1240 PULI RAJITHA  
19R11A1248 SREE ALEKHYA TEERTHALA  
19R11A1258 VITHANALA YASHWANTH NAG  
19R11A1259 YAGNA SRI THIRUPATHI  
19R11E0001 MBA  
19R11E0002 MBA  
19R11E0003 MBA  
19R11E0004 MBA  
19R11E0013 MBA  
19R11E0015 MBA  
19R11E0016 MBA  
19R11E0019 MBA  
19R11E0020 MBA  
19R11E0022 MBA  
19R11E0023 MBA  
19R11E0024 MBA  
19R11E0025 MBA  
19R11E0026 MBA  
19R11E0031 MBA  
19R11E0033 MBA  
19R11E0035 MBA  
19R11E0036 MBA  
19R11E0037 MBA  
19R11E0044 MBA  
19R11E0045 MBA  
19R11E0048 MBA  
19R11E0049 MBA  
19R11E0050 MBA  
19R11E0056 MBA  
19R15A0506 MANCHALA RAJINIBHARATHI  
19R15A0521 BOLLI UMARANI

  
**PRINCIPAL**  
Geethanjali College of Engg. and Tech.  
Cheeryal (V), Keesara (M), Medchal Dist.(T.S.)-501 301.

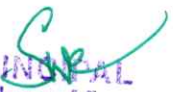

19R15A0522 MEDA NEERAJA  
524 Ch Vennela  
589 Rupa Reddy Vudumula  
5M8 M. Akhila  
Anil Kumar Puppala GCET  
AZRA ZAINEB GCET  
BONDA LEELARAM PRAKASH GCET  
D.VENKATESWARLU GCET  
Dean Academics  
Dr J. PARDHA SARADHI GCET  
DR. G. MAHESH GCET  
Dr. Puja S Prasad GCET  
E Swapna GCET  
ERUKALA MAHENDER GCET  
HARINIKRISHNA GCET  
indira kumawat  
K GNANA MAYURI GCET  
K Shashanka GCET  
K.LAVANYA GCET  
LAKKAKULA KAVYA GCET  
MORIGADI VISHWASHANTHI GCET  
Muddula Anusha  
NIVEDITHA GOPIGARI GCET  
P.ARCHANA GCET  
Padakanti Sri kanya 42  
Parvathi Siva Jyothi Bhogadi  
pravalika goud  
PREETI PRASADA GCET  
Rakesh Cherry  
Ravikanth Thogarcheti GCET  
S RAMANJANEYULU GCET  
S.RADHA GCET  
S.VALLISREE GCET  
SALADI SARITHA GCET  
SALAGRAMA SURYANARAYANA GCET  
SANTHOSH KUMAR MEDISHETTI GCET  
SHAINAZ BEGUM GCET  
Shirisha 519  
Sita Madhavi Guda  
Sravan Kumar Gampa  
SRIGIRI.KRISHNAPRIYA GCET  
UDAYASRI GIDIGAM GCET  
V. NAGA SUHASINI GCET  
VARDHINI RN GCET  
VIJAYA LAKSHMI GCET  
YALLA SWATHI TEJAH GCET

  
PRINCIPAL  
Geethanjali College of Engg. and Tech.  
Cheeryal (V), Keesara (M), Medchal Dist.(T.S.)-501 301.

94 Students

Total

136

Webinar on "Demystifying IPR" on Feb 12, 2021  
By Mr.G.Sravan Kumar, Patent Attorney



PRINCIPAL

Geethanjali College of Engg. and Tech.  
Cheeryal (V), Keesara (M), Medchal Dist.(T.S.)-501 301.



**Feedback responses on the Webinar "Demystifying IPR" conducted on Feb 12, 2021 GCET Hyderabad**

Timestamp	Email Address	Score	Full Name of the Participar
2/12/2021 20:06:41	mahender.cse@gcet.edu.i	0 / 1	Erukala Mahender
2/12/2021 20:06:50	mdafreen99@gmail.com	0 / 1	Mohammed Afreen
2/12/2021 20:07:06	Rakeshcherry004@gmail.c	0 / 1	Govindu rakesh
2/12/2021 20:07:14	naresh.kosuri@gmail.com	0 / 1	K Naresh babu
2/12/2021 20:07:19	vijay.cse@gcet.edu.in	0 / 1	M VIJAY BHASKER REDD
2/12/2021 20:07:31	sammetaashokkumar08@	0 / 1	SAMMETA ASHOK KUMA
2/12/2021 20:07:32	vijaykumarmahadevuni@g	0 / 1	Mahadevuni Vijay Kumar
2/12/2021 20:07:36	vs.bandaru2000@gmail.cc	0 / 1	Bandaru Vagdevi Sahasra
2/12/2021 20:07:37	vaishunaga23@gmail.com	0 / 1	Malladi Venkata Vaishnavi
2/12/2021 20:07:57	bpsjyothi@gmail.com	0 / 1	PARVATHI SIVA JYOTHI
2/12/2021 20:07:58	p.vaggmic@gmail.com	0 / 1	PATEL VAGGMIC REDDY
2/12/2021 20:08:14	rajshreerao6@gmail.com	0 / 1	Sanku Rajshree Rao
2/12/2021 20:08:46	vijayamba.k@gmail.com	0 / 1	Kollaparthi Vijaya Lakshmi
2/12/2021 20:08:47	obedbatchu@gmail.com	0 / 1	Batchu obed Emmanuel
2/12/2021 20:08:47	ajaysabban321@gmail.cor	0 / 1	Ajay sabban
2/12/2021 20:08:53	gurramvishnu0@gmail.cor	0 / 1	GURRAM VISHNU SAHIT
2/12/2021 20:08:54	mayuri.cse@gcet.edu.in	0 / 1	K GNANA MAYURI
2/12/2021 20:08:57	tadepallysainandini87436@	0 / 1	Tadepally Sai Nandini
2/12/2021 20:09:11	manaswini1120@gmail.co	0 / 1	movva manaswini
2/12/2021 20:09:18	2000.jeevani@gmail.com	0 / 1	Y Jeevani
2/12/2021 20:09:33	bolliumarani@gmail.com	0 / 1	Bolli Umarani
2/12/2021 20:09:34	Archanap949@gmail.com	0 / 1	P.Archana
2/12/2021 20:09:45	moraakhila1999@gmail.cc	0 / 1	MORA AKHILA
2/12/2021 20:09:52	sowmyaredde@gmail.com	0 / 1	KOMIRELLI SOWMYA
2/12/2021 20:09:55	kodakandlapinky@gmail.c	0 / 1	Kodakandla Navya
2/12/2021 20:10:02	ssn68@rediffmail.com	0 / 1	S Suryanarayana
2/12/2021 20:10:06	jahnnaviks11998@gmail.cor	0 / 1	KAMARAJUGADDA SREE
2/12/2021 20:10:51	kurapati.manasa13@gmai	0 / 1	KURAPATI MANASA
2/12/2021 20:11:00	govtham09@gmail.com	0 / 1	Kavdapu Govtham
2/12/2021 20:11:06	preetiprasada.cse@gcet.e	0 / 1	Preeti Prasada
2/12/2021 20:11:16	vrrreddy@gmail.com	0 / 1	Rupa Reddy Vudumula
2/12/2021 20:11:18	naupal.mba@gcet.edu.in	0 / 1	Mr K Naupal Reddy
2/12/2021 20:12:23	pulirajitha2001@gmail.con	0 / 1	Puli Rajitha
2/12/2021 20:12:25	haritha708.cse@gcet.edu.	0 / 1	P HARITHA
2/12/2021 20:12:42	tejahyalla.it@gcet.edu.in	0 / 1	Swathi Tejah Yalla
2/12/2021 20:12:51	sadhanaumareddy@gmail	0 / 1	U SADHANA
2/12/2021 20:13:41	18r11a05n8@gcet.edu.in	0 / 1	SRIRAM VENKATA SAI S
2/12/2021 20:13:47	harinishiva.cse@gcet.edu.	0 / 1	Harini Krishna
2/12/2021 20:14:18	sweekruthi.0102@gmail.cc	0 / 1	D Sweekruthi
2/12/2021 20:16:13	ramanji.cse@gcet.edu.in	0 / 1	Ramanjaneyulu Seggem
2/12/2021 20:16:19	18r11a05p5@gcet.edu.in	0 / 1	VENGALASETTIAVINASH
2/12/2021 20:16:29	nive.gopigari@gmail.com	0 / 1	Gopigari Niveditha
2/12/2021 20:16:30	vishwashanthi5b9@gmail.	0 / 1	MORIGADI VISHWASHA
2/12/2021 20:17:00	18r11a0560@gcet.edu.in	0 / 1	Rose Mary Chinnam
2/12/2021 20:17:04	msjahnnavi17@gmail.com	0 / 1	Manda . Sai Jahnnavi
2/12/2021 20:17:28	sarahjuan27@gmail.com	0 / 1	J Sarah
2/12/2021 20:17:40	gattumahesh.fe@gcet.edu	0 / 1	Dr. G. MAHESH
2/12/2021 20:17:48	g56swapna.cse@gcet.edu	0 / 1	Swapna G
2/12/2021 20:17:52	hemamm2000@gmail.com	0 / 1	Murugan Rajam Meghna
2/12/2021 20:17:57	nikitha8668@gmail.com	0 / 1	Mettu Nikitha
2/12/2021 20:18:01	sureshkumarboddu9.8@gi	0 / 1	Boddu Suresh Kumar
2/12/2021 20:18:02	sariyurangu29@gmail.com	0 / 1	Sarayu Rangu
2/12/2021 20:18:08	radhika.amareshwari.it@g	0 / 1	N Radhika Amareshwari



2/12/2021 20:18:20 Ramyamamilla8@gmail.cc  
2/12/2021 20:18:34 gchand060@gmail.com  
2/12/2021 20:19:24 myselfnazeer@gmail.com  
2/12/2021 20:19:37 sanjayramkodisana1@gm:  
2/12/2021 20:20:27 deekshithashetty99@gmai  
2/12/2021 20:21:05 thararekha18@gmail.com  
2/12/2021 20:21:25 teja49830@gmail.com  
2/12/2021 20:21:26 srigiri.cheeki@gmail.com  
2/12/2021 20:22:03 sanjanachitreddy2410@gn  
2/12/2021 20:23:00 joshnitharangoli01@gmail.  
2/12/2021 20:23:10 lavanya.mba@gcet.edu.in  
2/12/2021 20:23:13 santoshkumar.cse@gcet.e  
2/12/2021 20:23:24 keerthanareddy056@gmai  
2/12/2021 20:23:31 shaliinii.007@gmail.com  
2/12/2021 20:23:56 shivanipavani91@gmail.cc  
2/12/2021 20:24:04 varsharavikanti@gmail.cor  
2/12/2021 20:24:05 shirishachityala4@gmail.co  
2/12/2021 20:24:13 tsreealekhya12@gmail.cor  
2/12/2021 20:27:00 navyadintyala@gmail.com  
2/12/2021 20:27:24 gajula.lakshitha@gmail.co  
2/12/2021 20:27:28 abhia0689@gmail.com  
2/12/2021 20:27:38 vaishnavivaraganti2508@g  
2/12/2021 20:28:17 radhacse@gcet.edu.in  
2/12/2021 20:28:58 jupallyprasannalaxmi@gm  
2/12/2021 20:29:44 mattaganesh168@gmail.c  
2/12/2021 20:30:23 18r11a05l1@gcet.edu.in  
2/12/2021 20:31:07 abhigba1426@gmail.com  
2/12/2021 20:31:14 18r11a05k8@gcet.edu.in  
2/12/2021 20:32:01 shivakumarpargi19@gmai  
2/12/2021 20:32:06 19r15a0523@gcet.edu.in  
2/12/2021 20:33:01 18r11a0583@gcet.edu.in  
2/12/2021 20:33:48 harsha7663@gmail.com  
2/12/2021 20:34:02 bhargavigattu596@gmail.c  
2/12/2021 20:34:27 maheshvarma7116@gmai  
2/12/2021 20:34:52 kammadivyasree2@gmail.  
2/12/2021 20:35:05 sanjanasudagani0507@gr  
2/12/2021 20:35:13 sairavi65@gmail.com  
2/12/2021 20:35:23 shaliniyalala25@gmail.con  
2/12/2021 20:35:24 18r11a05f4@gcet.edu.in  
2/12/2021 20:35:28 meghnapatnaik@gmail.co  
2/12/2021 20:36:05 bhatamgayathri@gmail.co  
2/12/2021 20:36:09 18r11a05n0@gcet.edu.in  
2/12/2021 20:36:30 vardhini.rm@gmail.com  
2/12/2021 20:36:52 Mamidinaveen5269@gma  
2/12/2021 20:37:11 saritha.3188ece@gcet.edu  
2/12/2021 20:37:31 saineha757@gmail.com  
2/12/2021 20:37:33 muddulaanusha26@gmail  
2/12/2021 20:37:34 nikhitamandava26@gmail.  
2/12/2021 20:37:53 vydehichakka19@gmail.cc  
2/12/2021 20:38:02 jyothiier275@gmail.com  
2/12/2021 20:38:04 anushagoudkoyyada@gmi  
2/12/2021 20:38:06 madhavipundru0405@gma  
2/12/2021 20:38:26 dumpamamatha123@gma  
2/12/2021 20:38:29 medaneerajaa@gmail.cor  
2/12/2021 20:38:45 gutlaashok2398@gmail.co

0 / 1 Ramya Mamilla  
0 / 1 Darise Gopichandu  
0 / 1 Mohammed Nazeer Ahme  
0 / 1 Sanjay Ram Kodisana  
0 / 1 badishetty deekshitha  
0 / 1 THARA REKHA KAKARAF  
0 / 1 G.Teja Narayana goud  
0 / 1 S.KrishnaPriya  
0 / 1 Ch.Sanja  
0 / 1 Joshnitha Rangolu  
0 / 1 K.LAVANYA  
0 / 1 Santhosh Kumar Medishet  
0 / 1 G.Sai Keerthana Reddy  
0 / 1 G. Shalini  
0 / 1 Kandikonda Shivani  
0 / 1 Varsha Ravikanti  
0 / 1 Chityala Shirisha  
0 / 1 T Sree Alekhya  
0 / 1 Dintyala Navya Sree  
0 / 1 GAJULA LAKSHITHA  
0 / 1 Abhijeet Mukherjee  
0 / 1 Vaishnavi Varaganti  
0 / 1 SEELABOYINA RADHA  
0 / 1 Jupally prasanna laxmi  
0 / 1 Matta Sri Shiva Sai Ganes  
0 / 1 Chinnala Avinash Chalam  
0 / 1 M P Abhinav  
0 / 1 Bunga vinay  
0 / 1 BAINLA SHIVA KUMAR  
0 / 1 G VINAY REDDY  
0 / 1 Mothe Sahithi  
0 / 1 harsha vardhan  
0 / 1 Gattu Bhargavi  
0 / 1 K. Mahesh Varma  
0 / 1 Kamma Divya sree  
0 / 1 Sanjana Sudagani  
0 / 1 RAVIKANTH THOGARCH  
0 / 1 Yalala Shalini  
0 / 1 Chintamaneni Meghana  
0 / 1 N MEGHNA PATNAIK  
0 / 1 BAHATAM GAYATHRI  
0 / 1 Palvai Varshini  
0 / 1 Vardhini RN  
0 / 1 Mamidi Naveen Kumar  
0 / 1 Dr Saladi Saritha  
0 / 1 Sai Neha Manda  
0 / 1 Muddula Anusha  
0 / 1 Mandava Nikhita  
0 / 1 CHAKKA VYDEHI  
0 / 1 P. G. Jyothi  
0 / 1 Koyyada Anusha Goud  
0 / 1 Pundru Madhavi  
0 / 1 Dumpa Mamatha  
0 / 1 Meda Neeraja  
0 / 1 G Ashok Kumar

  
**PRINCIPAL**  
Geethanjali College of Engg. and Tech.  
Cheerayal (V), Keesara (M), Medchal Dist (T.S.)-501 207.



2/12/2021 20:38:55 kastoori.nagaraju@gmail.c  
2/12/2021 20:39:34 sagarbhukya26@gmail.coi  
2/12/2021 20:40:46 18r11a05p2@gcet.edu.in  
2/12/2021 20:41:15 megha1796md@gmail.cor  
2/12/2021 20:41:26 pavank02331@gmail.com  
2/12/2021 20:41:28 18r11a05p0@gcet.edu.in  
2/12/2021 20:41:30 vk7788934@gmail.com  
2/12/2021 20:41:35 dhruvithachalla@gmail.cor  
2/12/2021 20:42:32 padakantisrikanya1999@g  
2/12/2021 20:43:25 vikas.cse@gcet.edu.in  
2/12/2021 20:44:06 akshaykumar9826@gmail.  
2/12/2021 20:44:57 srinivaskanakala.cse@gce  
2/12/2021 20:45:44 rashmisree2k@gmail.com  
2/12/2021 20:47:29 sunnygupta.ks@gmail.com  
2/12/2021 20:47:37 puja.cse@gcet.edu.in  
2/12/2021 20:50:18 lochanrampal5@gmail.com  
2/12/2021 20:50:21 Annedachandrakala.cse@  
2/12/2021 20:51:16 18R11A0550@gcet.edu.in  
2/12/2021 20:51:23 tanmayi.kasthuri@gmail.c  
2/12/2021 20:53:25 18r11a0577@gcet.edu.in  
2/12/2021 20:54:34 mattaganeshchoudary@g  
2/12/2021 20:55:24 shainaz.mba@gcet.edu.in  
2/12/2021 21:05:51 kalyani.kdk@gmail.com  
2/12/2021 21:10:22 neelaneelapalatejashree@  
2/12/2021 21:13:23 Sreenidhireddy77@gmail.c  
2/12/2021 21:21:06 jayavamsi.chitta@gmail.cc  
2/12/2021 21:24:34 eswapna.cse@gcet.edu.in

0 / 1 K Nagaraju  
0 / 1 Bhukya.Sagar  
0 / 1 Tanmayi Kasthuri  
0 / 1 M D.Megha  
0 / 1 Thigulla Pavan Kumar  
0 / 1 Sudheshna jinna  
0 / 1 TATTARI VINAY KUMAR  
0 / 1 CHALLA DHRUVITHA  
0 / 1 P.srikanya  
0 / 1 Cholleti Vikas  
0 / 1 T akshay Kumar  
0 / 1 Srinivas Kanakala  
0 / 1 Kaithapu Rashmisri  
0 / 1 Kura srinath  
0 / 1 Dr. Puja S Prasad  
0 / 1 lochan rampal  
0 / 1 A.chandrakala  
0 / 1 Sai Krupa Chary Arendra  
0 / 1 Tanmayi Kasthuri  
0 / 1 Lanke Ravi Teja  
0 / 1 Pinnamaraju Naga Shivani  
0 / 1 Mrs.SHAINAZ BEGUM  
0 / 1 K DURGA KALYANI  
0 / 1 NEELAPALA TEJASHREE  
0 / 1 Balramgari Sreenidhi  
0 / 1 C.Jaya Vamsi Krishna  
0 / 1 E.SWAPNA

  
PRINCIPAL  
Geethanjali College of Engg. and Tech.  
Cheeryal (V), Keesara (M), Medchal Dist.(T.S.)-501 301.

ad

Official Mail Id of the partic	Mobile Number of the parti	You are a	Your rating on the overall
mahender.cse@gcet.edu.i	09912058007	Assistant Professor	5
18r11a0581@gcet.edu.in	+917673992089	Student	5
Rakeshcherry004@gmail.c	9398325483	Student	4
Knareshbabu.it@gcet.edu.	9246163228	Assistant Professor	5
vijay.cse@gcet.edu.in	9399973289	Assistant Professor	5
19r11a0590@gcet.edu.in	+918978442628	Student	5
19r11e0033,Vijay Kumar	9705570121	Student	5
18r11a05k4@gcet.edu.in	8187001237	Student	4
18r11a05m7@gcet.edu.in	8978440990	Student	5
apsjyothi.mba@gcet.edu.ir	9908931864	Assistant Professor	4
17r11a05m5@gcet.edu.in	9154713099	Student	5
18r11a05j2@gcet.edu.in	8374267418	Student	4
vijayalakshmi.mba@gcet.e	09652678391	Assistant Professor	5
18r11a05k6@gcet.edu.in	6309069561	Student	4
ajaysabban321@gmail.cor	9515038010	Student	5
gurramvishnu0@gmail.cor	8688852080	Student	5
mayuri.cse@gcet.edu.in	9490118495	Assistant Professor	5
18r11a05j5@gcet.edu.in	6303657059	Student	5
18r11a0584@gcet.edu.in	9573175266	Student	4
2000.jeevani@gmail.com	6302587681	Student	4
19r15a0521@gcet.edu.in	7993397172	Student	4
archanap949.cse@gcet.ec	9966180887	Assistant Professor	4
18r11a05m8@gcet.edu.in	6302071878	Student	5
Sowmyaredde@gmail.cor	9515412872	Student	4
kodakandlapinky@gmail.c	9676882010	Student	4
ssn68.ece@gcet.edu.in	09849928925	Professor	5
jahnnaviksl1998@gmail.cor	8897619891	Student	5
19R11E0031	9347487657	Student	5
govtham09@gmail.com	9392963042	Student	5
preetiprasada.cse@gcet.e	9959833844	Assistant Professor	5
vrrreddyy@gmail.com ( or	8790529042	Student	5
naupal.mba@gcet.edu.in	9989451320	Assistant Professor	5
19r11a1240@gcet.edu.in	9121573842	Student	4
haritha708.cse@gcet.edu.	9866510951	Assistant Professor	5
tejahyalla.it@gcet.edu.in	9010703203	Assistant Professor	5
usadhana.cse@gcet.edu.ii	96184 92854	Assistant Professor	5
18r11a05n8@gcet.edu.in	8500867947	Student	5
harinishiva.cse@gcet.edu.	8096045946	Assistant Professor	5
sweekruthi.0102@gmail.cc	8309113792	Student	4
Ramanji.cse@gcet.edu.in	7396383291	Assistant Professor	5
18r11a05p5@gcet.edu.in	8186935194	Student	5
nive.gopigari@gcet.edu.in	8977675510	Research Scholar	5
vishwashanthi.cse@gcet.e	8885360207	Assistant Professor	4
rosychinnam47@gmail.cor	7083079614	Student	4
18r11a0578@gcet.edu.in	7993349188	Student	4
sarahjuan27@gmail.com	9949513341	Student	4
gattumahesh.fe@gcet.edu	9581774878	Associate Professor	5
g56swapna.cse@gcet.edu	9573388069	Assistant Professor	5
18r11a05m9@gcet.edu.in	9652473692	Student	4
19r11e0037edu@gmail.co	8639730315	Student	5
sureshkumarboddu9.8@gi	6303076523	Student	5
18r11a05n7@gcet.edu.in	9100585921	Student	4
radhika.amareshwari.it@g	9966090752	Assistant Professor	5



18r11a0526@gcet.edu.in	6303946400	Student	5
18r11a0514@gcet.edu.in	8639693903	Student	5
myselfnazeer@gmail.com	9618443415	Student	4
sanjayramkodisana1@gm:	9381165822	Student	5
19R11E0002	8247085001	Student	5
18r11a05j6@gcet.edu.in	7794001161	Student	5
Teja49830@gmail.com	7032858781	Student	5
skpriya.ece@gcet.edu.in	9440490378	Associate Professor	5
19r11a1208@gcet.edu.in	7386862401	Student	4
18r11a05m0@gcet.edu.in	9550871308	Student	4
lavanya.mba@gcet.edu.in	8500179169	Assistant Professor	5
santoshkumar.cse@gcet.e	+919666423065	Assistant Professor	5
18r11a0567@gcet.edu.in	7093012271	Student	4
Shaliinii.007@gmail.com	8686350602	Student	4
18r11a05m2@gcet.edu.in	7997593494	Student	4
18r11a05n5@gcet.edu.in	6305381590	Student	5
19R15A0519@gcet.edu.in	9347280334	Student	4
19r11a1248@gcet.edu.in	9989026001	Student	4
18r11a05f6@gcet.edu.in	8919596003	Student	5
gajula.lakshitha@gmail.co	9177294210	Student	5
abhijeetmukherjee239@gr	9542285947	Student	4
18r11a05p4@gcet.edu.in	9676725314	Student	5
radhacse@gcet.edu.in	9849166200	Assistant Professor	5
jupallyprasannalaxmi@gm	9390383342	Student	4
18r11a0388@gcet.edu.in	9652822329	Student	4
18r11a05l1@gcet.edu.in	9959879935	Student	5
abhigba1426@gmail.com	8919707712	Student	4
18r11a05k8@gcet.edu.in	9505522418	Student	5
Shivakumarpargi19@gmai	9705914047	Student	4
19r15a0523@gcet.edu.in	8106569937	Student	5
sahithisk9@gmail.com	9381225473	Student	4
harsha7663@gmail.com	09652313833	Student	3
18r11a05g2@gcet.edu.in	6309292759	Student	5
maheshvarma7116@gmai	8639197415	Student	4
18r11a05m1@gcet.edu.in	8374272852	Student	4
18r11a05n9@gcet.edu.in	07702664002	Student	4
ravikanth.mba@gcet.edu.i	9908188454	Professor	5
shaliniyalala25@gmail.con	9701292249	Student	4
chintamanenimeghanaa@	7382001314	Student	4
18r11a05h4@gcet.edu.in	9963333945	Student	4
bhatamgayathri@gmail.co	9642973441	Student	5
palwai.varshini@gmail.con	9603783171	Student	5
vardhini.mba@gcet.edu.in	09000765505	Assistant Professor	5
19r11e0035@gcet.edu.in	7893146302	Student	5
saritha.3188ece@gcet.edu	+919966344292	Associate Professor	5
18r11a05h8@gcet.edu.in	9640770757	Student	5
18r11a0529@gcet.edu.in	9381130612	Student	5
nikhitamandava26@gmail.	9441535258	Student	4
18r11a05k9@gcet.edu.in	9490477009	Student	5
19r11e0044@gctc.edu.in	6309839239	Student	4
18r11a05m4@gcet.edu.in	9666016126	Student	5
18r11a05n4@gcet.edu.in	6304437968	Student	5
19R11E0013 MBA	7569451502	Student	4
19r15a0522@gcet.edu.in	9390307899	Student	5
19r11e0022@gcet.edu.in	6309394850	Student	4

  
**PRINCIPAL**  
 Geethanjali College of Engg. and Tech.  
 Cheeryal (V), Keesara (M), Medchal Dist.(T.S.)-501 301.

knagaraju.fe@gcet.edu.in	9848354063	Assistant Professor	5
sagarbhukya26@gmail.com	9121561685	Student	5
tanmayi.kasthuri@gmail.com	949355889	Student	5
19r11e0036@gcet.edu.in	7330835646	Student	5
18r11a05p3@gcet.edu.in	9640768127	Student	5
18r11a05p0@gcet.edu.in	7093246007	Student	4
vk7788934@gmail.com	7680913161	Student	5
18r11a05l0@gcet.edu.in	7675039597	Student	5
padakantisrikanya1999@g	8309153043	Student	4
vikas.cse@gcet.edu.in	7673985905	Assistant Professor	4
akshaykumar9826@gmail.	7396709904	Student	4
srinivaskanakala.cse@gce	7799236048	Assistant Professor	4
17r11a04g6@gcet.edu.in	8897447543	Student	4
19R11E0030 mba	9032614746	Student	4
puja.cse@gcet.edu.in	07330860535	Associate Professor	4
Lochanrampal.cse@gcet.edu	+917989373947	Assistant Professor	5
Annedachandrakala.cse@	9550460205	Assistant Professor	5
18R11A0550@gcet.edu.in	8367364924	Student	5
18r11a05p2@gcet.edu.in	9493558889	Student	5
lankeraviteja7@gmail.com	8919043537	Student	4
18r11a05n2@gcet.edu.in	9100716195	Student	4
shainaz.mba@gcet.edu.in	8801057680	Assistant Professor	5
Durgakalyani.cse@gcet.edu	08688481234	Assistant Professor	5
18r11a05h3@gcet.edu.in	9494249824	Student	4
Sreenidhireddy77@gmail.c	9381426659	Student	5
18r11a05l2@gcet.edu.in	8639518022	Student	5
eswapna.cse@gcet.edu.in	9701518079	Assistant Professor	5
			4.585185185
			91.7037037

  
**PRINCIPAL**  
 Geethanjali College of Engg. and Tech.  
 Cheeryal (V), Keesara (M), Medchal Dist.(T.S.)-501 301.



The session is	Which of the following did	What is your overall rating	Any other suggestions/corr
Excellent	Content delivery, Interactio	5	No
Good	Content delivery, Subject k	4	
Very good	Content delivery	4	No
Good	Content delivery, Subject k	5	
Excellent	Content delivery, Interactio	5	
Excellent	Subject knowledge of the s	4	-
Good	Subject knowledge of the s	4	
Very good	Content delivery, Interactio	4	
Very good	Subject knowledge of the s	5	
Very good	Content delivery, Subject k	4	Nil
Excellent	Subject knowledge of the s	5	
Very good	Content delivery, Interactio	5	None
Excellent	Clarity and accuracy	5	Good session
Very good	Content delivery, Interactio	4	Nice session it's interactive
Good	Interaction	4	Gud sir
Very good	Clarity and accuracy	5	-
Excellent	Content delivery, Interactio	5	
Very good	Subject knowledge of the s	5	
Very good	Content delivery, Subject k	5	
Good	Subject knowledge of the s	4	
Very good	Content delivery, Subject k	4	No
Good	Subject knowledge of the s	4	
Excellent	Content delivery	5	no
Good	Content delivery, Subject k	4	No
Good	Content delivery, Subject k	4	It was a good session
Very good	Subject knowledge of the s	5	
Excellent	Content delivery, Doubts c	5	No
Very good	Subject knowledge of the s	5	No
Very good	Content delivery, Doubts c	4	No
Excellent	Content delivery, Doubts c	5	
Very good	Subject knowledge of the s	4	Make it more interactive
Excellent	Content delivery, Subject k	5	Nil
Very good	Interaction, Subject knowle	4	
Good	Clarity and accuracy	5	Good
Excellent	Content delivery, Subject k	5	
Excellent	Interaction, Doubts clarifica	5	
Very good	Subject knowledge of the s	5	no
Excellent	Content delivery, Subject k	5	no
Very good	Subject knowledge of the s	4	
Excellent	Content delivery, Interactio	5	
Excellent	Content delivery	5	No
Very good	Subject knowledge of the s	5	
Good	Content delivery, Doubts c	4	Good session
Very good	Content delivery, Clarity ar	4	No
Very good	Content delivery, Interactio	5	-
Very good	Subject knowledge of the s	5	
Excellent	Subject knowledge of the s	5	very informative webinar
Excellent	Content delivery, Subject k	5	
Very good	Content delivery, Subject k	4	It was good
Very good	Subject knowledge of the s	5	-
Excellent	Interaction, Doubts clarifica	5	No
Very good	Content delivery, Subject k	4	..
Excellent	Subject knowledge of the s	5	None

*SAP*

Very good	Content delivery, Doubts c	4 A very Useful Session.
Very good	Clarity and accuracy	5 No
Good	Content delivery, Subject k	4
Excellent	Clarity and accuracy	5 Nice suggestion for future
Excellent	Content delivery, Interactio	5 This seminar have a great
Very good	Content delivery, Doubts c	5 Interaction can be more
Good	Interaction	5 No
Excellent	Clarity and accuracy	5 No
Very good	Clarity and accuracy	4
Very good	Doubts clarification, Subje	4 -
Excellent	Content delivery, Interactio	5
Excellent	Clarity and accuracy	5
Very good	Interaction	4
Very good	Content delivery	4
Good	Content delivery, Interactio	4 none
Very good	Content delivery, Interactio	5
Good	Doubts clarification, Subje	4 -
Very good	Clarity and accuracy	4
Very good	Content delivery, Interactio	5 -
Excellent	Content delivery, Doubts c	5
Average	Doubts clarification	4
Excellent	Content delivery, Doubts c	5 No
Excellent	Subject knowledge of the s	5 Insightful session on IPR
Very good	Subject knowledge of the s	5 -
Very good	Interaction	4 Not applicable
Excellent	Content delivery, Subject k	5
Excellent	Content delivery, Subject k	5
Very good	Content delivery, Interactio	5 No
Very good	Content delivery	4 Nothing
Excellent	Content delivery, Interactio	5
Very good	Content delivery, Subject k	4
Good	Doubts clarification	4
Excellent	Content delivery, Subject k	5 No
Good	Subject knowledge of the s	4 -
Very good	Content delivery, Interactio	4 NO
Good	Content delivery, Subject k	4
Excellent	Content delivery, Doubts c	5
Good	Content delivery, Doubts c	4
Very good	Interaction, Doubts clarifica	5 -
Very good	Content delivery, Subject k	4 NA
Excellent	Content delivery	5
Excellent	Content delivery, Interactio	5
Excellent	Content delivery, Interactio	5 Thank you
Excellent	Content delivery, Interactio	5
Very good	Content delivery, Subject k	5 Good webinar on IPR
Very good	Content delivery, Interactio	4 No
Very good	Content delivery	5 No
Very good	Content delivery, Subject k	4
Excellent	Doubts clarification	4
Good	Subject knowledge of the s	4 No
Excellent	Clarity and accuracy	5 -
Excellent	Content delivery	5 No
Very good	Content delivery, Subject k	5 no
Very good	Content delivery, Interactio	5 -
Very good	Content delivery, Doubts c	4 Need more sessions



Excellent	Subject knowledge of the s	5
Excellent	Clarity and accuracy	5 Good
Excellent	Content delivery, Interactio	5
Excellent	Content delivery, Interactio	5 No
Very good	Content delivery, Subject k	5 None
Very good	Content delivery, Interactio	4 Over all good
Excellent	Clarity and accuracy	5 Good session
Very good	Content delivery, Subject k	5 none
Very good	Doubts clarification	4
Very good	Content delivery, Clarity ar	4
Good	Clarity and accuracy	4
Good	Content delivery, Interactio	4 Good
Very good	Content delivery, Interactio	4
Very good	Subject knowledge of the s	4
Very good	Subject knowledge of the s	4 NA
Excellent	Content delivery, Subject k	5
Excellent	Content delivery	5 No
Excellent	Content delivery, Interactio	5
Very good	Content delivery, Interactio	5 No
Good	Clarity and accuracy	4 none
Very good	Content delivery, Interactio	4 not applicable
Excellent	Clarity and accuracy	5 Nothing
Very good	Subject knowledge of the s	5 No
Good	Doubts clarification, Subje	4 No
Good	Interaction	4 No
Excellent	Clarity and accuracy	5 None
Excellent	Content delivery, Interactio	5 If we get more information

4.577777778

91.55555556

  
**PRINCIPAL**  
**Geethanjali College of Engg. and Tech.**  
**Cheeryal (V), Keesara (M), Medchal Dist.(T.S.)-501 301.**

# Geethanjali College of Engineering and Technology

(UGC Autonomous)

Cheeryal(V), Keesara(M)  
Medchal District, Hyderabad  
Telangana State

## Report on Prototype Validation and Converting Prototype to a Startup.

A Three Day Workshop on Design Thinking and Critical Thinking was organized for the students of GCET from 28<sup>th</sup> February to 2<sup>nd</sup> March, 2021. From then, students continued to consolidate the project work under the continuous monitoring and supervision by the undersigned. The necessary support from the college was provided till the completion of the projects. An exhibition on 6<sup>th</sup> and 7<sup>th</sup> July followed by a session on prototype validation and converting prototype to a Startup was conducted on 24-07-2021.

Mr.Y.V.N.Phani Kishore, Team Lead ACCELQ Software Solutions, IIC council, Dr. Radhika judged the projects and the session/lecture to convert the prototypes to a StartUp was delivered by Mr. Y.V.N. Phani Kishore

Total Number of students participated: 62

Faculty involved: 8

### Teams and Project titles

S.No	Team No.	Name of the student	Roll No	Branch and Section	Project Title	Remarks
1	1	VA Tanmai	20R11A6759	CSE-DS	Automation Parking System	Working Model
2		P.Srikanth	20R11A0232	EEE	Automation Parking System	
3		MD.Waseem	20R11A1242	IT		
4		Sanka Gayathri	20R11A04A4	ECE-B		
5	2	Sanjeev.S	20R11A0148	CE	Automatic Drip Irrigation System using Solar Cell	Working Model
6		R.Saunak Jain	20R11A0444	ECE-B		
7	3	Hari Sarada	20R11A05K9	CSE-D	Self-reporting robotic arm-Arduino based	Working Model
8		Sathwik Parasa	20R11A6943	CSE-IoT		
9		Ashrith Gadeela	20R11A05J4	CSE-D		
10	4	K.Anusha	20R11A05E6	CSE-C	Growpal-supplying trees according to the customers' needs	Website
11		M.Karthik	20R11A04M0	ECE-D		
12		K.Sai Karthik	20R11A0147	CE		
13		T.Venkata Sai Anirudh	20R11A04B9	ECE-B		

PRINCIPAL  
Geethanjali College of Engg. and Tech.  
Cheeryal (V), Keesara (M), Medchal Dist.(T.S.)-501 301.



		Sharma			Wind Turbine	Model
43		G.Harshitha	20R11A6618	CSE-AI&ML		
44		Sufia	20R11A05H0	CSE-C		
45		Ashish	20R11A04G8	ECE-C		
46	14	B.Yamini Sri Bhavya	20R11A0468	ECE-B	Waste Crushing Dustbin	Demo Model
47	15	Sharan Naaroju	20R11A0496	ECE-B	Face tracker using open CV and arduino	Demo Model
48		Sai Teja	20R11A6624	CSE-AI&ML		

**Banner:**



**Geethanjali College of Engineering and Technology**

*(UGC Autonomous Institution Accredited by NBA & NAAC, Permanently Affiliated to JNTUH, ISO 9001:2015 certified) Cheeryal (V), Keesara (M), Medchal. Dist. 501381*



**IEEE Women in Engineering (WiE), Power and Energy Society (PES) GCETSB and Indian Society for Technical Education (GCET) in collaboration with Institution's Innovation Council of Geethanjali College of Engineering and Technology invite you to**

**Session on Prototype Validation – Converting Prototype into a Start-Up on 6<sup>th</sup> and 7<sup>th</sup> July 2021**

**Gallery**



**Geethanjali College of Engg. and Tech.**  
 Cheeryal (V), Keesara (M), Medchal Dist.(T.S.)-501 301.



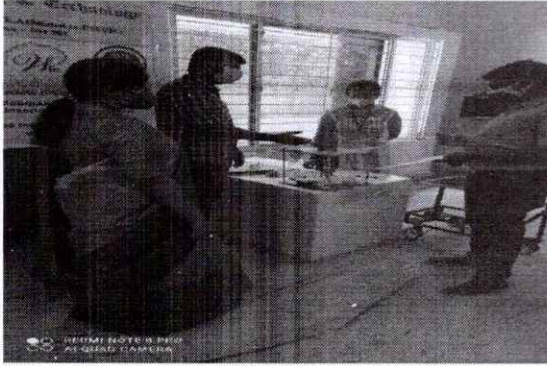

**Pics of the session on “Prototyping validation and converting prototype to startup” conducted on 24<sup>th</sup> July**

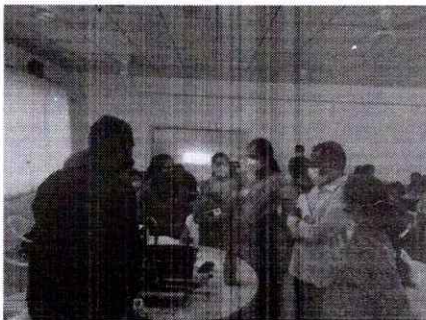

Listening to support



How can a Self-reporting robotic arm help us?

**PRINCIPAL**  
Geethanjali College of Engg. and Tech.  
Chaeryal (V), Keesara (M), Medchal Dist.(T.S.)-501 301.



Dr.B.Nagamani  
Associate Professor of English

Ms.V.Manjula  
Asst.Professor of Physics

Dr. Madhuri Bayya  
Advisor, IEEE GCET SB

Dr. Aruna Bharathi  
Advisor, WIE IEEE GCET SB

Ms. S. Jyiothirmayee  
IEEE SB GCET

**Link to the Recording**

As it was an offline event, there is no recording made, other than the pictures.

Link to the Social media advertising this

<https://www.facebook.com/geethanjaliingroupofinstitutions/photos/a.1563232947145905/2261757387293454/>



PRINCIPAL  
Geethanjali College of Engg. and Tech.  
Cheeryal (V), Keesara (M), Medchal Dist.(T.S.)-501 301.



Name of the student	Roll Number	Branch	Section	Team No.	Title of the Project	Sign
<b>Team 4</b>						
K. Anusha	20R11A056	CSE	C	4	GROWPAL	V. [Signature]
M. Karthik	20R11A046	ECE	D	4	GROWPAL	[Signature]
K. Sai Karthik	20R11A0147	CIVIL ENGINEERING	A	4	GROWPAL	[Signature]
T. Venkatajyothi	20R11A0454	ECE	B	4	GROWPAL	[Signature]
<b>Team 5</b>						
Vempaty Bharu Vamsi	20R11A6259	CSE-CS	A	5	Reducing the queue time at billing counter	[Signature]
M. Geethavali	20R11A0900	ECE	B	5	Reducing the queue time billing counter	[Signature]
Anupali Akash	20R11A6909	CSE-IDT	A	5	"	[Signature]
Tata Tanisha	20R11A6954	CSE-IDT	A	5	"	[Signature]
<b>Team 6</b>						
J. Lakshmi Swaya	20R11A0481	ECE	B	6	Topic - the modern library	[Signature]
Ananya Chupuri	20R11A0469	ECE	B	6	Topic - the modern library	[Signature]
Shrithara Bharad	20R11A0552	Cse	A	6	Topic - the modern library	[Signature]
Rishi Deshmukh	20R11A0088	Civil	A	6	Topic - the modern library	[Signature]



Name of the student	Roll Number	Branch	Section	Team No.	Title of the Project	Sign
<b>Team 11</b>						
Saavika	20R11A6615	CSE-AIML	A	11	medi bot	
Asifa anjum	20R11A6405	ECE A	A	11	medi bot	
VENU	20R11A604	ECE A	A	11	medi bot	

<b>Team 10</b>						
Ashwan Kodte	20R11A6763	CSE-DS	A	10	PHYTECH	
M. Naga mahitha	20R11A6733	CSE-101	A	10	PHYTECH	
Arya Kodte	20R11A6732	CSE-DS	A	10	PHYTECH	
B. Saketh Ram	20R11A6569	CSE-B	B	10	PHYTECH	

<b>Team 12</b>						
J. Manik	20R11A6462	ECE	B	12	Solar power charger	
P. Venkata bhargava	20R11A6444	ECE	B	12	Solar power charger	
K. Radhika	20R11A6464	ECE	B	12	Solar power charger	



Name of the student	Roll Number	Branch	Section	Team No.	Title of the Project	Sign
<b>Team 13</b>						
M. Jaganmoula Shama	20R11A0491	ECE	B	13	vertical axis wind turbine	[Signature]
G. HARSHITHA	20R11A6611	CSC - AIML	B	13	vertical axis wind turbine	[Signature]
Sufia	20R11A0580	EE	C	13	vertical axis wind turbine	[Signature]
ASLISH	20R11A0468	ECE	C	13	"	[Signature]
<b>Team 14</b>						
B. Yaminu Sai Bhaya	20R11A0468	ECE	B	14	Waste crushing Machine	Jaminu
<b>Team 15</b>						
Sharan Naaraju	20R11A0446	ECE	B	15	Fall tracker using open CV and arduino	[Signature]
Sai teja	20R11A6624	CSC	AIML	15	"	[Signature]



## Report

on

### Design Thinking and its implementation at Institute level

**Title of the Webinar:**

Design Thinking and its implementation at Institute level

**Date:**

17th October, 2020 (Saturday)

**Resource Person:**

Prof. P. Achutha Rao, Design and Innovation Trainer and Consultant; Former Centre Head, National Institute of Design R& D Campus, Bangalore

**Time:**

10AM to 12 Noon (online google meet session)

**Google Meet Link used:**

<https://meet.google.com/kgj-kijv-xna>

Recording

link:

<https://drive.google.com/file/d/1WN6bQ6NpzU929ksFt0bWPCCWZZgC3WIT/view?usp=sharing>

**Number of Participants:**

94

**Coordinator**

Prof. O.V.P.R. Sivakumar

**List of the Participants**

S.No.	Name of the Faculty member
1	M VIJAY BHASKER REDDY GCET
2	A. Sree Lakshmi GCET
3	A.CHANDRAKALA GCET
4	A.UMA DEVI GCET
5	Achutha Rao
6	Anil Kumar Puppala GCET
7	B SUBBARAO GCET
8	B. HARI KUMAR GCET
9	Bhasker.Bommara GCET
10	BHUKYA RAMU GCET
11	BOJJA KOWSHIK REDDY GCET
12	DEVULAPALLI VARUN KUMAR GCET
13	Dr R S Raju Gcet
14	Dr. DEVAIAH MALKAPURAM GCET
15	Dr. G. SOMA SEKHAR GCET

  
PRINCIPAL  
Geethanjali College of Engg. and Tech.  
Cheeryal (V), Keesara (M), Medchal Dist.(T.S.)-501 301.

62	SHANKER ALETI GCET
63	SRINIVAS MULKALAPALLI GCET
64	Subhash Kamal GCET
65	SURAMANYAM A GCET
66	UDDALA SREEKANTH GCET
67	V.NAVODAYA GCET
68	YALLA SWATHI TEJAH GCET
69	YECHURI SIVARAMAKRISHNA GCET
70	APPALA RAJU UPPALA GCET
71	Dr CH RAMESH BABU GCET
72	Dr. ARUNA BHARATHI M GCET
73	Dr. S T Raj Mohan Gcet
74	DR.SHANKAR JAKKULA GCET
75	Faculty Gcet
76	J. MRUDULA GCET
77	K GNANA MAYURI GCET
78	KASTURI DIVYA GCET
79	PANGULURI PADMAVATHI GCET
80	S.RADHA GCET
81	SRIGIRI.KRISHNAPRIYA GCET
82	U SADHANA GCET
83	SK.NUSLIN BIBI GCET
84	S. TIRUPATI RAO GCET
85	P. MERCY KAVITHA GCET
86	S.L.ANUSHA GCET
87	AADHARI SANTHOSH GCET
88	B.ANITHA GCET
89	B.SREELATHA GCET
90	B.SUNEETHA GCET
91	D DIVYA VANI GCET
92	Dr. SK. MAHAMMAD ALI GCET
93	M RAJA KRISHNA KUMAR GCET
94	UMARANI MARRI GCET

*SHE*

Geethanjali College of Engg. and Tech.  
Cheeryal (V), Keesara (M), Medchal Dist.(T.S.)-501 301.



4. Prof.Dr.S. Udaya kumar, Principal, GCET thanked the speaker for sparing his valuable time, proposed that we will visit him in person in Bangalore and also welcomed him to visit GCET after the pandemic.
5. There were several interesting questions raised by the audience.
6. Prof.Sivakumar proposed vote of thanks and concluded the session.

Prof. O.V.P.R. Sivakumar, Coordinator

A handwritten signature in green ink, appearing to read 'Sivakumar', is written below the typed name.



Winners of JHUB Innovation Challenge 2021

TOP 5 TEAMS

Sl No.	Name of the Idea	Name of the Team Lead	College Name
1	Surface Disinfection System	Myson Sunny	Geethanjali College of Engineering and Technology
2	SOLAR CONTROLLED INTEGRATED PEST MANAGEMENT SYSTEM	Ch.Divya Sri	Priyadarshini institute of science and technology for women
3	QUALITY MONITORING OF MID DAY MEAL	B V LAKSHMI	Mallu Reddy Engineering College For Women
4	Safety SHOE	Akanksha Kacham	BVRIT HYDERABAD College of Engineering for Women
5	Vaari -Solution to save water	G tharuni	sreenidhi institute of science and technology

Consolation Prize

Sl No.	Name of the Idea	Name of the Team Lead	College Name
1	DPK(Dhanyam Panchae Kiosk)	Sai Alekhya Chitturi	Vidya Jyothi Institute of Technology

PRINCIPAL  
 Geethanjali College of Engg. and Tech.  
 Cheeray (V), Keesara (M), Medchal Dist.(T.S.)-501 301.



**Innovation Challenge 2021**  
**Shortlisted Teams for Round 2**

Sl. NO.	Name of the Idea	Name of the Team Lead	College Name	Stream
1	VAALI(Vaani to Lipi)	A. Nishika Geetkar	JNTUH	Technology
2	Vehicle Speed Tracking System on Urban Roadways	A.Vasavi	Mallareddy Engineering College For Women(Autonomus)	Technology
3	PAWS	Aarthi Mupparthy	ACE Engineering college	Both
4	HYBRID VEHICLE - THE FUTURE TRANSPORT	ABBURI DIVYAVANI	Jawaharlal Nehru Technological University Hyderabad	Technology
5	ASVR SOLUTIONS	Aditya Meka	Geethanjali College of Engineering and Technology	Technology
6	Safety SHOE	Akanksha Kacham	BVRIT HYDERABAD College of Engineering for Women	Technology
7	Agriculture weedeer	Akhil goud	St. Martin's engineering college	Both
8	Drone invigilator	Akhil Kumar Guduri	BVRIT	Both
9	Smart Trolley for supermarket	Anuhya pittala	Sreenidhi institute of science and technology	Both
10	HEMPCRETE	ARAVELLI SRI CHARAN	GEETHANJALI COLLEGE OF ENGINEERING AND TECHNOLOGY	Technology
11	AI Joystick	Aravind nayak	jntuhcem	Both
12	CARSHARING	Ashwini Kyasani	St. Martin's Engineering College	Both
13	Electric bulb controller	B Lalith Kumar	Jawaharlal Nehru Technological University, Kukatpally	Technology
14	QUALITY MONITORING OF MID DAY MEAL	B V LAKSHMI	Malla Reddy Engineering College For Women	Technology
15	Image Caption generator for Visually Impaired	B. Ram Charan	Vidya Jyothi Institute of Technology	Technology
16	floor cleaning robot	Bandi Akhil	Geethanjali college of engineering and technology	Technology
17	AQUA LAUTUS	BHUVAN PRATAP AGARWAL	SREENIDHI INSTITUTE OF SCIENCE AND TECHNOLOGY	Both
18	AUTOMATIC LIBRARY BOOK SHELVING ROBOT.	BHUVAN PRATAP AGARWAL	sreenidhi institute of science and technology	Both
19	Mental Health Physical Support	Boreddy Arthi Reddy	Vidya Jyothi Institute of Technology	Both
20	SOLAR CONTROLLED INTEGRATED PEST MANAGEMENT SYSTEM	Ch.Divya Sri	Priyadarshini institute of science and technology for women	Both
21	Edible spoon	Ch.sreya	ACE Engineering college	Business
22	Mask Reuse Box - Nagakesari Punarapi Petika	Challapalli Sreya Sree	Vidya Jyothi Institute Of Technology	Both
23	Low cost prosthetic arm	CHERUKU HARISCHANDRA PRASAD	MLR INSTITUTE OF TECHNOLOGY	Technology
24	Cold storage System	CHINTAPATLA ABHIRAM	B V Raju Institute of Technology	Business
25	E-NOTE, THE ECO-FRIENDLY FUTURE	CHINTHA SAI CHARAN	JNTUCEH,KUKATPALLY	Both

*Sreya*

PRINCIPAL  
Geethanjali College of Engg. and Tech.  
Keesara (M), Medchal Dist. (T.S.)-501 001.



















52	a chrome extension which enhances user productivity and health	Pagadala Sushma	Malla Reddy Engineering College for Women (Autonomous)	Technology
53	H1-Cell	Piyush Kumar	Malla Reddy college of Engineering	Both
54	MAJADOOR	Pravali	Malla Reddy Engineering College for women (Autonomous)	Both
55	HYBRID SUPERCAPACITOR	Pulipaka Manogna	St.Martins engineering college	Technology
56	Chargeit - Laptop on the go	Ravi Teja D	Mahindra University	Technology
57	Blyndr -APP	Reethika Kakani	Malla Reddy Engineering College for Women (Autonomous)	Technology
58	RESUME SCREENING	Rekha Choudhary	Malla Reddy Engineering College For Women	Technology
59	DPK(Dhanyam Panchnae Kiosk)	Sai Alekhya Chitturi	Vidya Jyothi Institute of Technology	Both
60	DNA STORAGE SYSTEM	Sai Suraj	St Martin's engineering college	Technology
61	Travelquipo	Satyajit Dash	Malla Reddy Engineering College	Business
62	Design and fabrication of vaccum refrigerator	Seelam Tarun kumar	Visakha technical campus	Technology
63	REDUCING STRESS THROUGH TECH	Sonali priya	Talla Padmavathi College of engineering	Technology
64	Blockchain E-Voting Done Right: Privacy and Transparency with Public Blockchain	T. Srikanth Reddy	St. Martin's Engineering College	Technology
65	Samrt Health Card	TATAPUDI APARNA	MALLA REDDY ENGINEERING COLLEGE FOR WOMEN	Technology
66	CHAUSER SMART SHOE RACK	THANGELLA VINAY KUMAR REDDY	SREENIDHI INSTITUTE OF SCIENCE AND TECHNOLOGY	Technology
67	Braille tablet	Tinnavalli vyshnavi	Mallareddy engineering college for women	Technology
68	E-WASTE MANAGEMENT	Varun Thaduri	JNTUH College of Engineering,Hyderabad	Technology
69	Traveller GPS Alerts	Vasa Ganesh	CVR COLLEGE OF ENGINEERING	Technology
70	Car Boot Space Secure using Image Recognition	Vemula Varun	CMR Engineering College	Both
71	Generic Robot for Fishing	Vineeth Yelagandula	Sreenidhi institute of science and technology	Both
72	ELECTRI-CITY.	VOORE NANDU	JB INSTITUTE OF ENGINEERING AND TECHNOLOGY	Technology
73	Air Cursor	Yash Periwal	Sreenidhi institute of science and technology	Technology

*Srk*

**PRINCIPAL**

**Geethanjali College of Engg. and Tech.**  
Cheeryal (V), Reesuru (M), Medchal Dist.(T.S.)-501 301.



-  MY PROFILE
-  Innovation Council
-  Manage Activity
-  Innovation Ambassador
-  Innovation Contest 2020
-  Manage Pre-Incubation / Incubation Details
-  Announcement from IIC Institutes
-  Notification
-  Schemes / Programs for Participation
-  ATL School Linkage
-  e-Learning Resources
-  Innovation & Startups
-  Refer Institute for IIC Registration
-  Performance Card
-  Suggestion
-  Download
-  Contact us
-  Join us
-  IIC Guide and Portal Manual

L and PoC submission in Quarter 2) is not enabled in the portal. Institutes will get notification for the same in due course of time.

< Institute Details  Add Teaching/Non teaching Members  Student Members  External Member  >

+ Add Teaching/Non teaching Members





Name & Details	Department	Designation	Qualification	Position	Experience in Years	Roles	Action
<b>Dr. Anil Kumar Puppala</b> apuppala@gmail.com 9160624935	Electrical and Electronics Engineering	Professor	Doctorate	Convener, Innovation Activity Coordinator	13	Convener, Innovation Activity Coordinator	 
<b>OVPR Siva Kumar</b> ogirala.sivakumar@gmail.com 9490933019	ECE	Professor	Post Graduate	Internship Activity Coordinator, IPR Activity Coordinator	20	Internship Activity Coordinator, IPR Activity Coordinator	 
<b>Dr. Spandana</b> spandanamadhav@gmail.com 9603296965	ECE	Assoc Prof	Doctorate	NIRF Coordinator, Member	4	NIRF Coordinator, Member	 
<b>Dr. Harsha Praneeth</b> praneethharsha.ce@gcet.edu.in 8008635080	CE	Assoc Prof	Doctorate	Member	3	Member	 
<b>Sudarshan Rikka</b> rsujyo1@gmail.com 9849224047	ME	Assoc Prof	Post Graduate	ARIIA Coordinator, Member	16	ARIIA Coordinator, Member	 
<b>Dr. Madhuri Bayya</b> madhuribayya.eee@gcet.edu.in 9010020113	EEE	Associate professor	Doctorate	Member	5	Member	 
<b>Dr. S. Vallisree</b> vallisree.ece@gcet.edu.in 7816005335	ECE	Associate professor	Doctorate	Start up Activity Coordinator, Member	4	Start up Activity Coordinator, Member	 
<b>Ms. Preethi Prasada</b> preetiprasada.cse@gcet.edu.in 9959833844	CSE	Assistant Professor	Post Doctorate	Social Media, Member	10	Social Media, Member	 
<b>Mr. Sandeep</b> psandeepk.me@gcet.edu.in 8978451261	ME	Associate professor	Post Graduate	Member	11	Member	 
<b>Dr. Anurag Gautam</b> ganurag13@gmail.com 7021337052	Freshman Engineering	Professor	Doctorate	Member	13	Member	 

Items per page: 10 1 - 10 of 12 < >

#### QUICK LINKS

- [▶ Home](#)
- [▶ Innovation Council](#)
- [▶ SIH](#)
- [▶ ARIIA](#)



















#### SOCIAL MEDIA LINKS

-  [Twitter](#)
-  [Facebook](#)
-  [Youtube](#)
-  [Instagram](#)

#### CONTACT US

-  [www.mic.gov.in](http://www.mic.gov.in)
-  [ic\\_mhrd@aicte-india.org](mailto:ic_mhrd@aicte-india.org)
-  011 2958 1239/1513/1223











**PRINCIPAL**  
**Geethanjali College of Engg. and Tech.**  
Cheeryal (V), Keesara (M), Medchal Dist.(T.S.)-501 301.

-  MY PROFILE
-  My Council
-  Manage Activity
-  Innovation Ambassador
-  Innovation Contest 2020
-  Manage Pre-Incubation / Incubation Details
-  Announcement from IIC Institutes
-  Notification
-  Schemes / Programs for Participation
-  ATL School Linkage
-  e-Learning Resources
-  Innovation & Startups
-  Refer Institute for IIC Registration
-  Performance Card
-  Suggestion
-  Download
-  Contact us
-  Join us
-  IIC Guide and Portal Manual

and PoC submission in Quarter 2) is not enabled in the portal, Institutes will get notification for the same in due course of time.

< Institute Details  Add Teaching/Non teaching Members  Student Members  External Member  >

+ Add Student Members Search





Name	Email	Discipline	Role	Semester	Stream	Year	Association With	Action
Harshith Varma	harshith.varma17@gmail.com	CSE	Social Media Leadercoordinator	3	CSE	2	Innovation & Entrepreneurship Development Cell (IEDC)	 
M Sunny Raj	theuseless653@gmail.com	CSE	Innovation Coordinator	5	CSE	2	Research Park	 
Shivani Chintala	20r11a6711@gcet.edu.in	CSE DS	Innovation Coordinator	1	CSE	2	Innovation & Entrepreneurship Development Cell (IEDC)	 
Hema Manogna Kollipara	20r11a6720@gcet.edu.in	CSE DS	Internship Coordinator	1	CSE	2	Innovation & Entrepreneurship Development Cell (IEDC)	 
Sai Prakash	19r11a05e1@gcet.edu.in	CSE	Startup Coordinator	1	cse	3	Start up cell under TEQUIP II	 
Mohammed Abid Hussain	20r11a6730@gcet.edu.in	CSE DS	IPR Coordinator	1	CSE	2	Innovation & Entrepreneurship Development Cell (IEDC)	 
Mr. Srikanth Patibandla	20r11a0232@gcet.edu.in	EE	Social Media Coordinator	1	EEE	2	Incubation & Pre-incubation Units	 
Mr. Madhav Bathina	20r11a0222@gcet.edu.in	EE	Innovation Coordinator	1	EE	2	Innovation & Entrepreneurship Development Cell (IEDC)	 
Mr. Neela Tharun Kumar	20r11a0229@gcet.edu.in	EE	Startup Coordinator	1	EE	2	Start up cell under TEQUIP II	 
J Sanjay Kumar	20r11a0212@gcet.edu.in	EE	Startup Coordinator	1	EE	2	Start up cell under TEQUIP II	 

Items per page: 10 1 - 10 of 14 << < > >>

QUICK LINKS

- [▶ Home](#)
- [▶ Innovation Council](#)
- [▶ SIH](#)
- [▶ ARIA](#)

SOCIAL MEDIA LINKS

-  [Twitter](#)
-  [Facebook](#)
-  [Youtube](#)
-  [Instagram](#)

CONTACT US

-  [www.mic.gov.in](http://www.mic.gov.in)
-  [lic.mbrd@aicte-india.org](mailto:lic.mbrd@aicte-india.org)
-  011 2958 1239/1513/1223

**PRINCIPAL**  
Geethanjali College of Engg. and Tech.  
Cheeryal (V), Keesari (M), Medchal Dist.(T.S.)-501 301.





MY PROFILE

My Council

Activity

Innovation Ambassador

Innovation Contest

Add Incubation Details

Announcement from IIC Institutes

Notification

Scheme

Online Session

Performance Card

Registration

Download

Contact us

IIC Guide and Portal Manual

IIC Annual Performance Report 2020-21

IIC Annual Performance Report 2019-20

### Performance Report

#### Cumulative Performance Report for the IIC Calendar Year 2020-21 Bifurcation of Score and Reward Points

Score: 78.33

Reward: 38.8889

Rating: 3.5/4

Fifth Star Rating: 0.5/1

Final Star: 4/5

Activity Type	Activity Submitted	Total Number of Activities Approved	Total Threshold Number of Activities	Score (for minimum prescribed activities)	Adjusted Cumulative Reward Points For Additional Activities Beyond the Threshold Numbers for Each Category (Reflection in multiple of 100 with activity score)
IIC Calendar Activity Score for 1 activity=5.55 Minimum 9 activities	17	16	9	50 (Max Score=50)	38.89
MIC driven Activity Score for 1 activity=2.5 Minimum 8 activities	6	6	8	15 (Max Score=20)	0
Self-driven Activity Score for 1 activity 3.33 Minimum 9 activities	4	4	9	13.33 (Max Score=30)	0
<b>Total</b>	<b>27</b>	<b>26</b>	<b>26</b>	<b>78.33</b> 100	<b>38.8889</b>

#### Effective score range for Star allocation from Quarter 1 to Quarter 4:

Score Range	Star allocation
0<Score<=25	1
25<Score<=50	2
50<Score<=75	3
75<Score<=100	3.5

#### Score range for 5th Star allocation:

Score Range	Star allocation
0<Score<50	0
Score=>50	0.5

#### Parameters for 5th Star:

S. No.	Parameter	Weightage	Score Earned
1	Reward Points earned	30	5
2	Submission of Annual Report of IIC Institution 2020-21	15	15
3	Participation in Innovation Ambassador Training Program 10	10	10
4	Shortlisted Student innovation teams from IIC institutions have reached the 3rd stage (Business Plan development) as part of the National Innovation Contest 2020.	10	0
5	Participation and Hosting of Toycathon 2021 program of MIC	10	10
6	Participation in NISP	10	10
7	Participation in ARIIA	10	10
8	Innovation Ambassadors from the IIC institutions had engaged as Mentor to the student teams as part of the National Innovation Contest 2020.	10	0
<b>Total</b>		<b>100</b>	<b>60</b>

#### Weightage of each activity type:

Activity Type	Weightage in %	Threshold Activities	Score for one Activity
	Q1 Q2 Q3 Q4		

PRINCIPAL  
Geethanjali College of Engg. and Tech.  
Cheerla (V), Keesara (M), Medchal Dist.(T.S.)-501 301.



To.

Date:-19-03-2021

The Principal,

Geethanjali College of Engineering & Technology,

Cheeryal, Hyderabad.

Sub: - Requesting to participate in Mars Society South Asia Competition

Respected Sir,

I Praveen Kumar working as an Asst.Professor in CSE Dept. and In-charge for ROBOTICS lab. Sir, Mars Society South Asia conducting Mars Drone Competition-International Planetary Aerial System(IPAS) Challenge. We are planning to participate in this event from our college. The registration fee is Rs.5000 and the equipment cost is approximately Rs.55,000. Kindly look into the possibility and request you to allow us to participate in this event.

Registration last date :-20-03-2021

Prize pool :- 51,000 INR.

Thanking you sir.

Yours Sincerely

Praveen Kumar,G.

Dept. Of CSE.

Submitted to Secretary for approval.

Signature  
9/19/2021

ALL  
POS. NEED  
IN

PRINCIPAL  
Geethanjali College of Engg. Tech.  
Cheeryal (V), Keesara (M), R.R. Dist. (A.P.) - 507 302

Signature  
Secretary



**Robothon**  
**Inter-College Robotics Competition – 2021**  
**Registration Form**

1. Name of College/Institute : Geethanjali College of Engineering and Technology
2. Number of Teams participating : Two
3. Details of Teams and Mentors along with category of Robot:

S. No	Team & Team Members	Mentor Name	Robot Category	Exhibition / Competition	Contact Number
a	<b>Team A</b>	Mr. G Praveen Kumar	Snake Robot	Competition	
	• Sai Varun (ME Dept)				6305174967
	• Harshith (CSE Dept)				9515396181
	• Sunny Raj (CSE Dept)				9705258299
	• Abhinav (ECE Dept)	6309441812			
	<b>Team B</b>	Mr. Shiva Prasad	Service Robot	Exhibition	
	• Vishnu Vardhan Reddy (CSE Dept)				6301625790
	• SaiKrupa Chary (CSE Dept)				8367364924
	• Harish (ECE Dept)				8074244734
	• Bhoopathi Patel (EEE)	9949184086			

4. Above details are correct and verified

  
Signature of Principal / HoD / Dean

Geethanjali College of Engineering and Technology,  
Cheeryal (V), Keasara (M), Medchal Dist. (T.S.) - 501 301.

[For Office Use Only]

  
**PRINCIPAL**  
Geethanjali College of Engg. Tech.  
Cheeryal (V), Keasara (M), R.R. Dist. (A.P.) - 501 301

MICEME - Hackath  
nomination

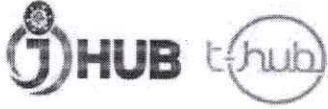

### Geethanjali College of Engineering and Technology

(UGC Autonomous Institution Accredited by NBA & NAAC,  
Permanently Affiliated to JNTUH, ISO 9001:2015 certified)  
Cheeryal (V), Keesara (M), Medchal, Dist. 501301

Mini/Major Projects and other projects at incubation center/JHuB /Jlabs - funded/supported by GCET 2020-21						
Name/Title of the project	Name of the participants	Roll No.	Year of study	Department	Amount Approved	Amount funded till date
Automated Titrator	M. Sunny Raj	19R11A05N4	II	CSE	32,860	39,772
	G. Abhinav	19R11A04M0	II	ECE		
Red Mud utilisation in the Production of Insulation bricks	Sri Charan	17R11A0105	IV	CE	20,000	10,000
	Ch Kalyani	17R11A0109	IV	CE		
	Vamshi Reddy	17R11A0104	IV	CE		
	Md. Wajjiuddin	17R11A0128	IV	CE		
Smart Electric Vehicle	Ch Sridhar	17R11A0205	IV	EEE	44,000	44,000
	C Yogesh Ram	17R11A0206	IV	EEE		
	Ch. Divya	17R11A0204	IV	EEE		
	A. Venkat Kaoushik	17R11A0201	IV	EEE		
	M Varun	17R11A0231	IV	EEE		
	T Rohit	17R11A0249	IV	EEE		
	V Sanjay	17R11A0251	IV	EEE		
	R Aditya	17R11A0245	IV	EEE		
P Bhargav	17R11A0248	IV	EEE			
Drone (IPAS Challenge)	Pola Sumanth-	18R11A05D1	III	CSE	55,000	5,000
	Sai Krupa Chary Arendra	18R11A0550	III	CSE		
	Abhishek Bhemisetty	18R11A0554	III	CSE		
	T Vishnuvardhan Reddy	18R11A0592	III	CSE		
	G Harshith	18R11A04M0	III	ECE		
	K Vamshi Krishna	18R11A04M8	III	ECE		

  
**PRINCIPAL**  
Geethanjali College of Engg. Tech.  
Cheeryal (V), Keesara (M), R.R. Dist. (A.P.) - 501301



	A Harish Kumar Gupta	18R11A0364	III	MECH		
	Srija	18R11A04P8	III	ECE		
	Shivani	18R11A04P7	III	ECE		
	P Sri Satya Harsha	18R11A04P1	III	ECE		
	Arvind Naik	18R11A04C7	III	ECE		
Surface disinfection	B. Abhishek	18R11A0554	III	CSE	4,500	Not yet started
	Sunny Raj	19R11A05N4	II	CSE		
	Oregunta Sai Varun,	19R11A0329	II	MECH		
	Harshith	19R11A05	II	CSE		
Admit Bot	B Divya Sai Sathwik	17R11A04A0	IV	ECE	3,80,800* sanctioned on 4th Dec 2019	Ongoing
	G Rashmi	17R11A04B0	IV	ECE		
	V Uma Kanth	17R11A04E4	IV	ECE		
	Sunny Raj	19R11A05N4	II	CSE		
	Oregunta Sai Varun,	19R11A0329	II	MECH		
	Harshith	19R11A05E5	II	CSE		

  
**PRINCIPAL**  
 Geethanjali College of Engg. Techn.  
 Geethanjali, Mysore - 575 004, Karnataka - 575 004.

u. 72



Geethanjali College of Engineering and Technology - GCET <info@gcet.edu.in>

**Request to forward this attachment to secretary sir.**

3 messages

**Radhika Dora** <headeegcet@gmail.com>  
To: info@gcet.edu.in

Thu, Apr 22, 2021 at 3:30 P

PFA

--  
Regards,

Dr. Radhika Dora  
Professor and HoD  
Dept. of EEE  
Geethanjali College of Engineering and Technology

*Canara.*  
*06061015577:*  
*Adv paid*  
*191*



**request for fund.jpg**  
536K

**Geethanjali College of Engineering and Technology - GCET** <info@gcet.edu.in>  
To: "greddy1962@yahoo.co.in" <greddy1962@yahoo.co.in>

Thu, Apr 22, 2021 at 3:37 F

Sir, please find the document attached for your kind perusal  
[Quoted text hidden]

Geethanjali College of Engineering and Technology  
Cheeryal(v), Keesara(m), Medchal Dist.,  
Telangana 501301

*AY*  
*Adv 44,000 -*  
*online paid on 29/4*  
*(through SBI)*  
*Dr. D. Radhika - Et*  
*EEE*



**request for fund.jpg**  
536K

**PRINCIPAL**  
Geethanjali College of Engg. Techn.  
Cheeryal (V), Keesara (M), Medchal Dist., Telangana - 501301

**Gaddam Ravinder Reddy** <greddy1962@yahoo.co.in>  
To: Geethanjali College of Engineering and Technology - GCET <info@gcet.edu.in>

Thu, Apr 22, 2021 at 8:20 I

Approved

Sent from my iPhone



Hyderabad,

Date: 22/04/2021

To,  
The Principal,  
Geethanjali College of Engineering and Technology,  
Cheeryal Village, Keesara Mandal,  
Hyderabad, Telangana 501301.

**Subject:** Requesting to provide Fund for our Major Project –“Smart Electric Motorcycle”

Respected Sir,

We, the students of EEE-4A are working on the Major Project – “Smart Electric Motorcycle”.  
The Total Cost of the E-Motorcycle calculates to Rs.57,000. We can fund up to Rs.13,000.  
Requesting you to provide funds for the rest of the amount for the project.

The Cost of the Components are Given Below:

Name of the Component	Price
1. Li-Ion Battery 60V,24Ah	Rs.28,000/-
2. 1.5Kw BLDC Motor	Rs.13,000/-
3. Motor Cycle	Rs.8,000/-
4. Fabrication	Rs.5,000/-
5. Smart Kit	Rs.3,000/-
<b>TOTAL COST</b>	<b>Rs.57,000/-</b>
<b>GROUP FUND AVAILABLE</b>	<b>Rs.13,000/-</b>
<b>REQUIRED AMOUNT</b>	<b>Rs.44,000/-</b>

Hoping that you will provide the fund for the rest of the project.

Thank You for your consideration.

Yours Sincerely

A. Venkat Kaushik (17R11A0201)

Ch. Sridhar Reddy (17R11A0205)

VN Sanjay (17R11A0251)

*forwarded to principal  
for kind sanction*

*A. Venkat Kaushik  
22/4/21*

*Submitted to Secretary  
for approval. Sit*

**PRINCIPAL**  
Geethanjali College of Engg. Techn.  
Keesara (V)  
Telangana (T)

*Sit*

7<sup>th</sup> Sept 2020

To  
The principal,  
Geethanjali College of Engineering and Technology,

Subject - A request to fund our project-AUTOMATED TITRATOR

Respected Sir,

This is to inform you that we dealing with a project since several months and we have spent around **Rs.14,000/-** . To complete our model and make it patent ready we additionally require components which cost around **Rs. 18,860/-** which makes a grand total of **Rs.32,860/-**

We would be grateful if you could fund the whole project. We assure you that we will utilize the maximum time of this pandemic and make sure is patent ready within a month. Please do the needful and oblige.

The list of additional components required is mentioned below.

S.No	Component	Quantity	Price	Total
1.	Burette stand	2	900/-	1800/-
2.	Burette clamps	2	300/-	600/-
3.	Glass flask(250ml)	1	400/-	400/-
4.	Borosilicate glass burette (50ml)	1	1700/-	1700/-
5.	Matrix shield(4x3)	1	440/-	440/-
6.	Magnetic stirrer	1	8000/-	8000/-
7.	16x2 LCD	1	100/-	100/-
8.	I2C LCD module	1	150/-	300/-
9.	PCF8574T IO Expansion module	1	300/-	300/-
10.	Ac to Dc 5v step down transformer	3	450/-	1350/-
11.	Stepper motor with driver	2	260/-	520/-
12.	Fiber finishing including man work	-	3500/-	3500/-
	<b>Funds further required</b>			<b>18860/-</b>
	<b>Funds already spent</b>			<b>14,000/-</b>
	<b>Funds Requested</b>			<b>32,860</b>

Thanking you,  
Yours sincerely,

M.SUNNY RAJ - 19R11A05N4 (CSE)

G.ABHINAV-19R11A04M0 (ECE)

*Ans* 7/9/20 (6309461812)

Project Mentor

*P. Navresh Kumar*  
7/9/2020

Incubation center shall monitor the project.

- I/c Incubation center

*Dr. Puppala*

*AK*  
*Adv-fory chow*

Submitted to Secretary for  
PRINCIPAL  
Geethanjali College of Engg. Tech.,  
Cheeryal (V), Keerasa (M), R.R. Dist. (A.P.) - 501 303

*Approved*  
*Shri G. Srinivas*  
Secretary  
9/9



Form to request reimbursement for the project sanctioned in Incubation CenterDate: 06/07/2021

Project Title: Automated Titrator

Name of the Mentor: P.Naresh Kumar, Assistant Professor. Dept of ECE.

S.No	Name of the team member	Dept	Roll No.	Phone	Email ID
1	M.SUNNY RAJ	CSE	19R11A05N4	9705258299	mysonsunnyraj@gmail.com
2.	G.ABHINAV	ECE	19R1A04M0	6309441812	abhinavgorthy@gmail.com

Project sanction letter Reference date: 7<sup>th</sup> Sep 2020

The following parts/items were purchased for the project Automated titrator.

S.No	Name of the part	Bought from the company	Price
1.	Magnetic stirrer 1 liters-Remi	Scientific World	7729/- ✓
2.	Retort Stand (9x6) Ord	Scientific World	1003/- ✓
3.	Burette-50ml BOROSILICATE	Scientific World	306/- ✓
4.	CONICAL FLASK-250ml	Scientific World	141/- ✓
5.	Fisher clamps (2)	Scientific World	212/- ✓
6.	Burette 50ml-N-Borosil	Scientific World	967/- ✓
7.	Gears Assorted.	Modern Electronics	295/- ✓
8.	L clamp	Modern Electronics	201/- ✓
9.	5v/12v/1amp adapter	Modern Electronics	425/- ✓
10.	Lcd 12c display	Modern Electronics	236/- ✓
11.	A4988 module	Modern Electronics	177/- ✓
12.	Nema 17 Motor	Modern Electronics	838/- ✓
13.	Jumper wires (M-M) (M-F)(F-F)	Modern Electronics	283/- ✓
14.	Keypad 4*3	Modern Electronics	295/- ✓
15.	I0 expansion pcf8574	Modern Electronics	354/- ✓
16.	T86600 module	Modern Electronics	826/- ✓
17.	24v/5amp power supply	Modern Electronics	649/- ✓
18.	Nema 23/30kg	Modern Electronics	3000/- ✓
19.	Nuts & bolts	HIC Fasteners	85/- ✓
20.	2mm Key	HIC Fasteners	15/- ✓
21.	Black box (30)	Maker Global	5605/- ✓
22.	Pcb along With design	Pcb board - Modern ,Soldering - Koti Shop vendor	380/- ✓
23.	Mechanical model Building along with nylon finish	Hardware Workshop- Ranigunj	2000/- ✓

TOTAL - 26022/-

PRINCIPAL

Geethanjali College of Engg. Tech.  
Cheeraj (V), Keeravani (M), R.R. Dist, (A.P.) - 501 307

Prior to this, we have submitted a document on 7<sup>th</sup> September 2020, where we have mentioned the amount we spent i.e. 13,750/- and a rough estimate of Rs.18,860/- to finish the whole project which indeed makes a grand total of 32,860/-

Whilst pursuing our project, there were few changes and we needed to add some extra components as well.

- Firstly, the **TB6600** color sensor gives accurate reading when the surrounding is dark. For this we 3D printed a black box of dimensions 14cm x14cm x11cm and kept it hollow so that burette can be kept inside it.
- Secondly, the stepper motor which we mentioned is small so we needed to replace it with a bigger one (**NEMA- 23/30kg**)
- Finally, we had to include a power supply to Motor as well as the color sensor.

Considering these, the budget exceeded by Rs.7162/- . The cost of each is mentioned below

S.No	Product	Estimated cost	Actual cost
1.	Black box	0/-	5605/-
2.	Stepper Motor(Nema-23)	540/-	3000/-
3.	Magnetic stirrer	8000/-	7729/-
4.	Burettes (Borosilicate)	1700/-	1273/-
5.	Burette Stand	1800/-	1003/-
6.	Fischer Clamps	600/-	212/-
7.	Conical flask	400/-	141/-
8.	TB6600 Module	0/-	826/-
9.	Mechanical work	3500/-	2000/-
10.	Power supply	1350/-	649/-

Here, there is a difference between the actual amount and estimated amount. We have included additional components and eliminated a few. The actual prices of some products is quite less than expected.

  
PRINCIPAL  
Geethanjali College of Engg. Tech.  
Cheeryal (V), Keesara (M), R.R. Dist. (A.P.) - 501 301



We request you to kindly reimburse the same from the project sanctioned. We shall submit the kit, a poster describing the complete project and a report of the same. Soft and hard copies of the invoices are being submitted along with this request note.

Thanking You

S.No	Team Member 1	Team Member 2
Name	M.SUNNY RAJ <i>[Signature]</i>	G. ABHINAV <i>[Signature]</i>
Phone	9705258299	6309441812
Email ID	mysonsunnyraj@gmail.com	abhinavgorthy@gmail.com
Department	CSE	ECE
Designation	2 <sup>nd</sup> year student	2 <sup>nd</sup> year student
Roll Number / Faculty ID	19R11A05N4	19R11A04M0
Year of study if Applicable	2019-2023	2019-2023

Faculty mentor should check the boxes applicable		Name	
Received the following		Email ID	P NARESH KUMAR
Kit and/or software code	<i>s/w code</i>	Department	<i>naresh.ece@gcet.edu.in</i>
Chart/Poster	-	Phone	ECE
Soft Copy (only) of Report	-	Phone	9866373432
Soft copies of the certificates of any competitions participated, won prizes	Merit/award certificate: -	Mentor's Comments for the next step	Major part of the <del>exp</del> Project Completed 90%. Testing part need to be done.
Relevant forms for filing IP	-	Signature	<i>[Signature]</i> 30/06/2021

Advance Amount - 13750/-  
 Total Expenditure - 39772/-  
 Sanctioned Amount - 32860/-  
 In charge of the Incubation Center:

Additional expenditure: 7162/-  
 Additional amount was due to trail and error of some components and unexpected increase in price.

Comments	The team shall submit another copy of this form after project completion. It is understood that major portion of the work is completed and mentor is monitoring the progress.
Date & Signature	<i>[Signature]</i> Dr. Anil Kumar Puppala 30 <sup>th</sup> Jun 2021

PRINCIPAL  
 Goethanjali College of Engg. Tech.  
 Chooray (V), Kossara (VI), A.R. Dist. (A.P.) - 501 300

We request you to kindly reimburse the same from the project sanctioned. We shall submit the kit, a poster describing the complete project and a report of the same. Soft and hard copies of the invoices are being submitted along with this request note.

Thanking You

S.No	Team Member 1	Team Member 2
Name	M.SUNNY RAJ <i>30/6/21</i>	G. ABHINAV <i>30/6/21</i>
Phone	9705258299	6309441812
Email ID	mysonsunnyraj@gmail.com	abhinavgorthy@gmail.com
Department	CSE	ECE
Designation	2 <sup>nd</sup> year student	2 <sup>nd</sup> year student
Roll Number / Faculty ID	19R11A05N4	19R11A04M0
Year of study if Applicable	2019-2023	2019-2023

Faculty mentor should check the boxes applicable		Name	P NARESH KUMAR
Received the following		Email ID	naresh.ece@gcet.edu.in
Kit and/or software code	S/W Code	Department	ECE
Chart/Poster	-	Phone	9866373432
Soft Copy (only) of Report	-	Mentor's Comments for the next step	Major part of the <del>EP</del> Project Completed 90%. Testing Part need to be done.
Soft copies of the certificates of any competitions participated, won prizes	Merit/award certificate:	Signature	<i>P. N. Kumar</i> 30/06/2021
Relevant forms for filing IP			

In charge of the Incubation Center:

Comments	The team shall submit another copy of this form after project completion. It is understood that major portion of the work is completed and mentor is monitoring the progress.
Date & Signature	<i>Dr. Anil Kumar Puppala</i> 30 <sup>th</sup> Jun 2021

**PRINCIPAL**  
Geethanjali College of Engg. Tech.  
Cheeruvu (V), Keesara (M), R.R. Dist. (A.P.) - 501 301



We request you to kindly reimburse the same from the project sanctioned. We shall submit the kit, a poster describing the complete project and a report of the same. Soft and hard copies of the invoices are being submitted along with this request note.

Thanking You

S.No	Team Member 1	Team Member 2
Name	M.SUNNY RAJ <i>[Signature]</i>	G. ABHINAV <i>[Signature]</i>
Phone	9705258299	6309441812
Email ID	mysonsunnyraj@gmail.com	abhinavgorthy@gmail.com
Department	CSE	ECE
Designation	2 <sup>nd</sup> year student	2 <sup>nd</sup> year student
Roll Number / Faculty ID	19R11A05N4	19R11A04M0
Year of study if Applicable	2019-2023	2019-2023

Faculty mentor should check the boxes applicable		Name	P NARESH KUMAR
Received the following		Email ID	naresh.eco@gcet.edu.in
Kit and/or software code	S/W Code	Department	ECE
Chart/Poster	-	Phone	9866373432
Soft Copy (only) of Report	-	Mentor's Comments for the next step	Major part of the <del>exp</del> Project completed 90%. Testing part need to be done.
Soft copies of the certificates of any competitions participated, won prizes	Merit/award certificate:	Signature	<i>[Signature]</i> 30/06/2021
Relevant forms for filing IP			

In charge of the Incubation Center:

Comments	The team shall submit another copy of this form after project completion. It is understood that major portion of the work is completed and mentor is monitoring the progress.
Date & Signature	<i>[Signature]</i> Dr. Anil Kumar Puppala 30/06/2021

*[Signature]*  
**PRINCIPAL**  
 Geethanjali College of Engg. Techn.  
 Cheyral (V), Keesara (M), R.R. Dist. (A.P.) - 501 305



Date: 24/03/21  
Place: Hyderabad

To  
The Principal,  
Geethanjali College of Engineering and Technology,  
Cheeryal,  
Madchal-501301.

Submitted to  
Secretary for  
approval

Secretary

To  
MC

Pending approval, 9/24/21  
initially an amount  
of Rs. 20,000/- may  
be given

Sub: Request funds for project work

Respected Sir,

We A. Sri Charan and team from the Civil Engineering Department, willing to go ahead on a project work on red mud utilization in the production of insulation bricks under the guidance of Dr. Harsha Praneeth, Associate Professor. The project we are in pursuit has enormous scope for publication or patenting. Hence, we request the administration to give an initial funding of Rs. 20,000 for the procurement of red mud and phosphogypsum material and basic investigations. This project would last for 2 years and a team from 3<sup>rd</sup> is already formed to take up this research further, after the initial studies by our team. We promise the funds will be spent honestly and the documents will be submitted on time.

Thanking You, sir.

Yours sincerely,  
*A. Sri Charan*  
A. Sri Charan  
Civil IV<sup>th</sup> Year  
17R11A0105  
Department of civil Engineering  
Mobile: 8121064088  
Email: araveelluricharan@gmail.com

*Harsha* 24/3/21  
Faculty co-ordinator  
DR. P. Harsha Praneeth  
Associate Professor  
Department of civil Engineering  
Mob: 8008635080  
Email: praneethharsha.ce@gcet.edu.in

*R. Prasanna* 24/3/21  
Head of the department  
DR. R. Prasanna Kumar  
Professor  
Department of civil Engineering  
Mob: 8712898489  
Email: civilhead@gcet.edu.in

Submitted to the Principal

The above student Mr. Sri Charan participated in AICTE CVA  
at New Delhi. He is highly motivated. Hence his request may  
please be considered. Dr. Harsha and the students should  
bring out a quality publication from the outcome of the work.

PRINCIPAL  
Geethanjali College of Engg. Tech.  
Cheeryal, Madchal, N.R. Dist. (A.P.) - 501301.

Date: 24/3/21





Ministry of  
Education  
Government of India



MoE's  
INNOVATION CELL  
(GOVERNMENT OF INDIA)



INSTITUTION'S  
INNOVATION  
COUNCIL  
(Ministry of Education Initiative)



# CERTIFICATE

Institution's Innovation Council (IIC) established at

Geethanjali College of Engineering and Technology, HYDERABAD

had undertaken various activities prescribed by Innovation Cell, Ministry of  
Education, Govt. of India to promote Innovation and Start-up in campus  
during the IIC calendar year 2020-21.

**Prof. Anil D. Sahasrabudhe**  
Chairman  
AICTE

**Dr. Abhay Jere**  
Chief Innovation Officer  
MOE, Innovation Cell

**Mr. Dipan Sahu**  
Assistant Innovation Director  
MOE, Innovation Cell

Certificate No : 280

Issued On : 2022-01-03





Ministry of Education  
Government of India



MoE's  
INNOVATION CELL  
(GOVERNMENT OF INDIA)



INSTITUTION'S  
INNOVATION  
COUNCIL  
(Ministry of Education Initiative)



## CERTIFICATE

Institution Innovation Council (IIC) established at

**GEETHANJALI COLLEGE OF ENGINEERING AND TECHNOLOGY, HYDERABAD**

**had undertaken various activities prescribed by Innovation Cell, Ministry of Education, Govt. of India to promote Innovation and Start-up in campus during the IIC calendar year 2019-20.**

**Prof. Anil D. Sahasrabudhe**  
Chairman, AICTE

**Sh. Amit Khare**  
Secretary, Department of Higher Education, MOE

**Dr. Abhay Jere**  
CIO, MOE, Innovation Cell

Certificate No : 280

Issued On : 2020-09-22





**Innovation Ambassador Training Program 2021  
Advanced Level**

S. No.	Date and Time	Session Title	Expert Name
1	30 <sup>th</sup> June 2021 03.00 PM to 04.30 PM (1.5 Hours)	I&E Initiatives & Programs of MoE for HEIs	Prof. Anil D. Sahasrabudhe, Chairman, AICTE Dr. Abhay Jere, Chief Innovation Officer, MIC  Mr. Dipan Sahu, Asst. Innovation Director, MIC
2	1 <sup>st</sup> July 2021 03.00 PM to 04.30 PM (1.5 Hours)	National Innovation and Startup Policy (NISIP): Guiding Framework for HEIs	Mr. Dipan Sahu, Asst. Director, MIC Dr. Pooja Rawat, Innovation Officer
3	2 <sup>nd</sup> July 2021 03.00 PM to 04.30 PM (1.5 Hours)	National Education Policy (NEP): Research, Innovation and Entrepreneurship for HEIs	Prof. Meenakshi Sood, Associate Professor, NITTTR, Chandigarh
4	5 <sup>th</sup> July 2021 03.00 PM to 04.30 PM (1.5 Hours)	Integration of Research, Innovation and Entrepreneurship in Academic Institutions and Economic Growth of Country	Dr. Sajeew Chandran, PhD Director, Adv. Drug Delivery Research & IVIVC/ Biopharmaceutics, Lupin Ltd. (Research Park), Pune.
5	7 <sup>th</sup> July 2021 03.00 PM to 04.30 PM (1.5 Hours)	Attaining Problem-Solution Fit and Market-Product Fit: Prototype Designing Process and Tools for Development of Minimum Viable Product (MVP)	Dr. Pankaj Parashar, Founder, Cutting Edge Medical Devices Pvt. Ltd. Indore
6	9 <sup>th</sup> July 2021 03.00 PM to 04.30 PM (1.5 Hours)	Quality Education Initiatives of AICTE and Ministry of Education	Prof. M P Poonia, Vice Chairman, AICTE Dr. Mohit Gambhir, Director, MIC  Mr. Dipan Sahu, Asst. Innovation Director, MIC
7	10 <sup>th</sup> July 2021 03.00 PM to 04.30 PM (1.5 Hours)	Understanding Technology Readiness Level (TRL), Manufacturing Readiness Level (MRL) and Investment Readiness Level (IRL) Stages & Implications in Innovation Development	Dr. Ashutosh Pastor, Incubation Manager – FITT, IIT Delhi
8	13 <sup>th</sup> July 2021 03.00 PM to 04.30 PM (1.5 Hours)	Innovation Management Process & Approaches at early Stage of Development of Innovation and Startup	Mr. Hiranmaya Mahanta, CEO, iHub, Amhedabad. Mr. Dipan Sahu, Asst. Innovation Director, MoE's Innovation Cell
9	15 <sup>th</sup> July 2021 03.00 PM to 04.30 PM (1.5 Hours)	Business Plan Development : Components and Stages in Business Plan Development	Mr. Arjun Panchal, Founder & CEO, papaZapata, Incubation Unit, SIBM, Pune
10	19 <sup>th</sup> July 2021 03.00 PM to 04.30 PM (1.5 Hours)	Validation of Business Opportunity: Application of Marketing Research Tools at the Early Stage of Startup – Case Study	Mr. Preet Deep Singh, AVP, Invest India, New Delhi
11	21 <sup>st</sup> July 2021 03.00 PM to 04.30 PM (1.5 Hours)	Attaining Business Fit: Startup Planning and Management	Mrs. Darshana Parmar Jain, CEO & Investor, Snapper Future Tech, Pune
12	23 <sup>rd</sup> July 2021 03.00 PM to 04.30 PM (1.5 Hours)	Legal Structures, Financial Risk Management, and Ethical Steps in Establishing Startups	Mr. Amit Singal, CA Founder, Startupbuddy Pvt. Ltd.
13	24 <sup>th</sup> July 2021 03.00 PM to 04.30 PM (1.5 Hours)	Generation and Management of IP at the Early Stage of Innovation and Startup Development	Dr. Sanjeev Majumdar, Manager, NRDC & Mrs. Pooja Bhatia, Chief Manager, I-TTO, FITT, IIT Delhi
14	26 <sup>th</sup> July 2021 03.00 PM to 04.30 PM (1.5 Hours)	Planning and Managing Incubation Support System in HEI & Resource Mobilization Strategy	Dr. Muthu Singaram, CEO, IIT Madras HTIC Incubator
15	28 <sup>th</sup> July 2021 03.00 PM to 04.30 PM (1.5 Hours)	Planning and Managing IPR Facility in HEIs: Technology Transfer Office (TTO) Model	Dr. Anil Wali, MD, Foundation for Innovation and Technology Transfer, IIT Delhi
16	31 <sup>st</sup> July 2021 03.00 PM to 04.30 PM (1.5 Hours)	Roles and Responsibility of Faculty Innovation Ambassadors: Faculty as Mentor and Engagement in Post Training Activities	Prof. Rajive Kumar, Member Secretary, AICTE Mr. Dipan Sahu, Asst. Innovation Director, MoE's Innovation Cell, New Delhi & IIC Team

**PRINCIPAL**  
Geethanjali College of Engg. and Tech.  
Cheyrel (V), Keesara (M), Medchal Dist.(T.S.)-501 301.



Anil Puppala &lt;apuppala@gmail.com&gt;

**Re: MHRD-IIC Innovation Ambassador Training Series - Confirmation Status - SCRO Zone (Andhra Pradesh and Telangana))**

1 message

innovation officer2 <innovationofficer2@aicte-india.org>  
Bcc: apuppala@gmail.com

Mon, Jan 27, 2020 at 5:49 PM

Dear Sir/Madam,

Please find attached the confirmation received for IIC Innovation Ambassador Training Program from IICs in SCRO zone. Please check with your institute status and confirm the nominated faculty for IIC Innovation Ambassador Training Program if not yet nominated. The deadline to nominate and confirm faculty for IIC innovation training program has been extended to 29th Jan 2020.

Also, attached is the step-by-step guide on how to "nominate" and "confirm" the faculty member for the training program.

Program Details:

**Schedule of IIC Innovation Ambassador Training Series for the SCRO ( Andhra Pradesh and Telangana) Region**

1. **Venue:** MLR Institute of Technology, Laxman Reddy Avenue, Dundigal, Quthbullapur Mandal, Hyderabad-043, Telangana, India.

**Date: 6th & 7th February 2020**

**Don't miss this opportunity to become an Innovation Ambassador of IIC-MIC. For more information please visit, <https://mic.gov.in/mic/iic-ia/>**

**Thanks and Regards****Team IIC****MHRD Innovation Cell****011-29581241; +91-9485992566****innovationofficer2@aicte-india.org**

On Mon, Jan 27, 2020 at 5:42 PM innovation officer2 <innovationofficer2@aicte-india.org> wrote:

Dear Sir/Madam,

Please find attached the confirmation received for IIC Innovation Ambassador Training Program from IICs in SCRO zone. Please check with your institute status and confirm the nominated faculty for IIC Innovation Ambassador Training Program if not yet nominated. The deadline to nominate and confirm faculty for IIC innovation training program has been extended to 29th Jan 2020.

Also, attached is the step-by-step guide on how to "nominate" and "confirm" the faculty member for the training program.



**Note:** IICs who have upgraded/completed their council as per the IIC2.0 can nominate and participate in IIC Innovation Ambassador Training Series.

**Don't miss this opportunity to become an Innovation Ambassador of IIC-MIC. For more information please visit, <https://mic.gov.in/mic/iic-ia/>**

**Thanks and Regards**

**Team IIC**

**MHRD Innovation Cell**

**011-29581241**

**innovationofficer2@aicte-india.org**

--

Thanks & Regards,  
Smart India Hackathon (SIH) 2019

--

Thanks & Regards,  
Smart India Hackathon (SIH) 2019

--

Thanks & Regards,  
Smart India Hackathon (SIH) 2019

---

**2 attachments**



**Steps to Confirm Nomination on IIC Portal.pdf**

1002K



**SCRO - Confirmation Status of Nominated Members.pdf**

862K

PRINCIPAL  
Gosthani Jai College of Engg. and Tech.  
Cheruvu (V), Narsarao (M), Madhwal (Dist), (R.S.), 501 301.



MHRD'S  
INNOVATION CELL  
(GOVERNMENT OF INDIA)



## Certificate of Membership

We appreciate the contribution of

**Dr. Anil Kumar Puppala, Member Secretary**

of Institution's Innovation Council established under the aegis of MHRD's Innovation Cell at  
GEETHANJALI COLLEGE OF ENGINEERING AND TECHNOLOGY, HYDERABAD for

the academic year 2018-19 .

*Abhay Jere*

Dr. Abhay Jere  
Chief Innovation Officer  
MHRD's Innovation Cell

*Dipanshu*

Mr. Dipan Sahu  
National Coordinator  
MHRD's Innovation Cell

*Sarim Moin*

Mr. Sarim Moin  
Zonal Coordinator  
MHRD's Innovation Cell



Principal  
Geethanjali College of Engg. and Tech.  
Cheerla (V), Krishna Dist., Andhra Pradesh-501301





Anil Puppala &lt;apuppala@gmail.com&gt;

## Urgent Notice - Final Reminder for Trained Innovation Ambassadors to Register in the IA Portal and Nominate for the Advance Level IA Training - Reg.

1 message

no-reply <admin@aicte-india.org>  
To: apuppala@gmail.com

Tue, Jun 8, 2021 at 1:36 PM

### Dear Innovation Ambassador,

We have been reached you all multiple times over email, SMS and other possible modes to enable you to bring into the Innovation Ambassador Portal designed for IAs to register and undertake the prescribed activities voluntarily to promote Innovation, Entrepreneurship and IP within and outside the institute, offer mentoring support to early stage innovation and startups, and drive the I&E activities at your IIC Institute.

It is noticed that, still you have not registered in the IA portal nor nomination to undergo IA advance level training. In this case, let us inform you that registration in IA portal, nominations for participating in the advanced level training, and conduct of prescribed activities are mandatory requirements to retain the IA tag. Upon failing to do so during the IIC3.0 calendar period (before 31<sup>st</sup> July 2021) then the Innovation Ambassador tag will be withdrawn and unable to carry forward the IA tag to IIC4.0.

Therefore, complete your registration latest by **15<sup>th</sup> June 2021** (extended) and nominate your participation in the advanced level IA training (will be conducted online from mid of June to mid of July) and conduct prescribed activities and submission of reports before 31<sup>st</sup> July 2021 (IIC3.0). The best performing IAs will be recognized along with the best performing IIC institutions.

Link to Register in IA portal : <https://ia.mic.gov.in/ambassador/sign-up>

Nominations for Basic & Advanced: Login into the IIC Portal- <https://iic.mic.gov.in/login>

**Ignore if you have already Registered & Nominated**

For any query, please contact Mr. Udyan Maurya at 01129581240 or write at [startupfellow3@aicte-india.org](mailto:startupfellow3@aicte-india.org)

Thanks & regards.

Dipan Sahu

Asst. Innovation Director

Ministry of Education's Innovation Cell

AICTE HQ, Nelson Mandela Road, Vasant Kunj,

New Delhi 110070 Phone: 011 29581226

PRINCIPAL  
Geethanjali College of Engg. and Tech.  
Cheerpal (V), Kasara (M), Malenah Dist. (R.S.), 501 301.



Geethanjali

Phone : 9182058187  
Website: www.geethanjalinstitutions.com  
info@gcet.edu.in

## Geethanjali College of Engineering and Technology AUTONOMOUS

(Accredited by NAAC "A" Grade; ECE, CSE, EEE & ME, B.Tech Programs Accredited by NBA;  
Approved by AICTE, New Delhi; Permanently Affiliated to JNTUH)  
Sy. No. 33 & 34, Cheeryal (V), Keesara (M), Medchal District. - 501 301.

### Undertaking for Utilization of Funds under the Scheme for Providing Support for Entrepreneurial and Managerial Development of MSMEs through Host Institute

**1.0** Name of authorized signatory Dr. Udaya Kumar Susarla for the Host Institution as Geethanjali College of Engineering and Technology as approved by the PMAC and its legal status, having its registered office at Survey No. 33 & 34, Cheeryal (Village), Keesara (Mandal), Medchal District – 501 301

### 2.0 RESPONSIBILITIES OF THE HOST INSTITUTE (HI)

2.1 The HOST INSTITUTE shall undertake to create (if not already created) an entity for undertaking innovative and entrepreneurship development activities and executing obligations under the proposed SCHEME. This entity is referred hence forth as the Business Incubator (BI).

2.2 The activities of the BI shall include:

2.2.1 Nucleation of new innovative ideas by creating the environment and opportunities for know-how providers, entrepreneurs and financiers to meet each other and form business teams;

2.2.2 Nurturing businesses in their start-up phase by creating and running an efficient BI offering not only space but also access to technology support, business mentoring, networks, scientific and information resources, and a generally conducive and supportive environment; and

2.2.3 Promoting and running an active programme for identification, creation, acceleration and translation (into practice) of innovative ideas suitable for new venture creation.

2.3 The HOST INSTITUTE shall provide ready-to-use, dedicated space for housing and operation of the BI.

Page 1 of 3

  
PRINCIPAL

Geethanjali College of Engg. and Tech.  
Keesara (M), Medchal Dist. (T.S.)-501 301.

Sponsored by TEJA EDUCATIONAL SOCIETY, HYDERABAD  
Geethanjali College of Engg. and Tech.  
Cheeryal (V), Keesara (M), Medchal Dist. (T.S.)-501 301.

Office : Sy. No. 33 & 34, Cheeryal (V), Keesara (M), Medchal Dist. - 501 301.

Phones : 9182058196, 9182058194



Government without prejudice, shall be entitled to terminate this registration and may take necessary action as per procedure.

#### 4.0 DISPUTE RESOLUTION

4.1 Any disputes shall be settled amicably between parties through the intervention and assistance of the Executive Head of the BI. If the dispute is not resolved, then the matter may be escalated to IA/NMIU and finally to Development Commissioner (MSME) whose decision shall be final and binding on all parties.

4.2 Any disputes, which cannot be settled amicably between the parties shall be referred for arbitration in accordance with the provision of Arbitration and Conciliation Act, 1996 to an arbitrator nominated by the Secretary, Department of Legal Affairs, M/o Law & Justice, Government of India. Provision of the Arbitration and Conciliation Act, 1996, as amended from time to time, shall be applicable. Courts in Delhi shall have jurisdiction in the matter.



Dr. S. Udaya Kumar

Principal

**PRINCIPAL**  
Geethanjali College of Engg. and Tech.  
Cheeryal (V), Keesara (M), Medchal Dist.(T.S.)-501 301.

  
**PRINCIPAL**  
Geethanjali College of Engg. and Tech.  
Cheeryal (V), Keesara (M), Medchal Dist.(T.S.)-501 301.

1. Details of Institution/Agency			
Institute Name	Geethanjali College of Engineering and Technology	Name of the Dean / Principal / Head of the Institute	Dr Udaya Kumar susarla
Address of Institution	Cheeryal Village, Keesara Mandal, Medchal district. PIN 501301		
State Name	TELANGANA	District Name	MEDCHAL MALKAJGIRI
Pin code	501301	Mobile No. +91	9866308257
Tel No. with STD code	09866308257	Email Id	info[at]gce[dot]edu[dot]in
2. Category of the Host Institute	Technical College		
3. About the Institution			
Date of establishment	30/06/2005	Number of teaching staff	246
Total no. of student	3664	Number of academic courses offered	8
Details of registration/affiliation/accreditation			
i) University affiliation	View/Download	ii) AICTE approval	View/Download
iii) NABL/ other accreditation	View/Download	iv) Any other	View/Download
Last two years audited annual accounts with auditor's report	View/Download	Number of students enrolled during last two years	1619
4. Details of existing/proposed Business Incubator:			
Already having Business Incubator Center	No		
Name of person in charge of BI	Dr.P.Anil Kumar	Designation of person in charge of BI	Professor
Email ID	apuppala[at]gmail[dot]com	Mobile No. +91	9160624935
Area of BI in Sq. ft.(Total area)	7104	Area of BI in Sq. ft.(buildup area)	7000
Details of ongoing innovative activities being undertaking by the Institution.	Innovation Activities Geethanjali College of Engineering and Technology is rated 3 stars by MHRD's Institution's Innovation council (IIC) because of the following innovative activities... • Organized design thinking Workshop in association with Mr. Abhimanyu Bhardwaj of 21id.com, a resource person identified by Telangana state's THub on 7th sept 2019 and for students of all years. Number of students attended 180. • Organized Samsya – Problem identification in association with JHub on 27th Sept 2019. Number of students participated - 135 • Organized Chaatra Vishwakarma Awards – regional competition on Innovative projects in association with AICTE Regional center on 13th Dec 2019. Number of participating teams – 33 from south central region. • Organized 36Hackathon on Robotic Process Automation in Association with JHub JNTUH on Dec 23-24th 2020. Number of students who took part 280 students • Organized 36 Hr Hackathon on "Agri-etechthon" Technology in Agriculture in association with JHub on Jan 5th-6th 2019. Number of students who participated - 290 • Organized workshop on Humanoid robotics on 9/8/19 – 10/8/19. Number of students participated – 98. • Organized workshop on Design Thinking - By Aravind Saurabh from Tech Mahindra. Dated: 16th March 2019. Number of students attended: 342. • Organized a talk on "Innovator's life and crossroads – a motivation speech" by Mr. Rahul an entrepreneur and also working with Infosys – 3rd Aug 2019. Number of students attended 130		
5. Industrial R&D / consultancy undertaken, if any, during previous two years(submit the certificate of completion of project from the client)	View/Download	6. Details of entrepreneurship development related activities undertaken during last two years, if any (submit proof of completion of activities)	View/Download
7. Details of any assistance taken from any of the schemes of this Ministry:			
8.			



## Application Remarks

Action	Date	Status	Remark
MSME-DI Hyderabad	07/Feb/2020 07:05:40 PM	Forwarded By IA	Geethanjali College of Engineering Technology, Cheryal (V), Keesra (M) Ranga Reddy Dist., Telangana- 501301 was established in the year 2005 and sponsored by Teja Education Society. The Institute was extended approval by AICTE for the academic year 2019-20 and affiliated to Jawaharlal Nehru Technological University, Hyderabad (JNTUH) for the year 2019-20. The UG courses of the Institute viz. Mech Engg, ECE,CSE, EEE are NBA accredited under Tier II valid upto 30-06-2021. The Institute has obtained NAAC accreditation with A grade for a period of five years from 09-06-2017. The Institute is recognized by UGC under Section 2(f) and 12(B) of the UGC Act 1956 and also having UGC Autonomous Status upto 2021-22. The Institute has established Institution Innovation Council (IIC) during the year 2018-19. DSIR, GOI has recognised Teja Education Society as Scientific Industrial Research Organisation (SIRO) for the period 01-04-2017 to 31-03-2020. The Institute has completed 3 Nos and ongoing 16 Nos of RD projects during 2017-20 (till now). The Institute has organized 10 nos of Entrepreneurship Development Activities during 2017-20( till date). The Institute was visited by officers of MSME-DI, Hyderabad on 10-01-20 and found adequate infrastructure and expertise for setting up of Host Institute/MSME Business Incubator.. The proposal is forwarded for consideration of NMIU, O/o DC(MSME) as Host Institute/ Business Incubator under the Scheme "Support for Entrepreneurial and Managerial Development of MSMEs through Incubators".
Dr Udaya Kumar susarla	04/Feb/2020 09:28:35 PM	Clarification sent by HI/BI	Included IIC certificate under Other, UGC Autonomous certificate, NBA, NAAC Accreditation documents, Research and Development activities. Mentioned innovative activities, category of Host Institute is changed to Technical category, financial statement along with principals letter. Corrected the units of the area of BI.
MSME-DI Hyderabad	04/Feb/2020 11:42:24 AM	Clarification Asked by IA	With reference to your request mail dated 04-02-20 for corrections in the application, you are requested to do the needful. It may be noted that no further request for correction will be permitted.
Dr Udaya Kumar susarla	03/Feb/2020 03:32:14 PM	Clarification sent by HI/BI	All items on feed back are uploaded
MSME-DI Hyderabad	13/Dec/2019 05:52:4 PM	Clarification Asked by IA	1.In the "Category of Host Institute" kindly mention as "Technical College" instead on "Other Professional Collge /Institutions." 2.SI No: 3 (iv) : Kindly upload UGC Autonomous, UGC 2(f)and 12(B), NIRF ranking, IIC certificate, etc, if any. 3.The balance sheet uploaded by you where the name of the trust i.e. Teja Educational Society hence there is mismatch in deciding the name of institute. Kindly upload your balance sheet and P & L A/c in the name of Geethanjali College of Engineering and Technology (in the letter head). It may be ensured that all documents should be uploaded in the name of your institute only not any other. 4.SI No(5) Kindly upload proofs of grants of Industrial R and D / Consultancy undertaken during last two years only along with certificate of completion from the client . 5.SI No: 4 : Kindly elaborate the details of ongoing innovative activities being undertaken by the Institution. SI No : 6 : Kindly upload the list of Entrepreneurial Development Activities only along with photos and proof of last two years For further clarification if any, kindly contact MSME -DI, Hyderabad

## Declaration

I have read the scheme guidelines and shall abide by all the terms and conditions required for seeking financial assistance. I hereby, declare that information given above is true to the best of my knowledge. Any information /documents that may be required to be verified shall be provided immediately before the concerned authority. I hereby, declare that I have not availed any financial assistance for the said purpose under any other scheme from any government agency.

Principal  
Geethanjali College of Engg. and Tech.  
Cheryal (V), Keesara (M), Medchal Dist.(R.S.),-501 301.



Anil Kumar Puppala <apuppala@gcet.edu.in>

### Geethanjali College of Engineering and Technology - A kit to automate an existing wheel chair

6 messages

Anil Kumar Puppala <apuppala@gcet.edu.in>

Tue, Dec 7, 2021 at 2:01

To: viiveck@upsugeglobal.co

Cc: prashanthmasadi.eee@gcet.edu.in, madhuribayya.eee@gcet.edu.in, "Dr. Udaya Kumar Susarla" <uksusarla@gcet.edu.in>, chairman@gcet.edu.in, eeehead@gcet.edu.in

Dear Mr. Viiveck Verma Ji

Thank you for coming over to Geethanjali college this morning and speaking to our students on (the need for) Social Entrepreneurship and 'being the change', instead of the 'so what' attitude. It was very enlightening!

Thank You also for stopping by to see one of our projects which was taken up as a startup company by our faculty.

Please find attached the video related to the same.

We shall be thankful if you could direct us and help us convert this to make a minimum viable product from the prototype that is built. As mentioned, a business model was also built around the same and we submitted the same to the TSIC competition.

Thanking You

Anil

--  
Anil Kumar Puppala Ph.D.  
(State University of New York at Buffalo, New York)  
Professor, Dept of EEE,  
I/C Incubation Center,  
Geethanjali College of Engineering and Technology  
Mobile: +91 916 062 4935

#### 2 attachments



1.jpg  
130K

Electric\_Wheel\_Chair.mp4  
9098K

Mail Delivery Subsystem <mailer-daemon@googlemail.com>  
To: apuppala@gcet.edu.in

Tue, Dec 7, 2021 at 2:02 PM



#### Address not found

Your message wasn't delivered to viiveck@upsugeglobal.co because the domain upsugeglobal.co couldn't be found. Check for typos or unnecessary spaces and try again.

PRINCIPAL  
Geethanjali College of Engg. and Tech.  
Chervyl (O), Keerava (M), Medchal Dist.(T.S.)-501 301.



# Telangana Assistive Technology Summit 2.0

AT Summit 2.0 is a redefined and revised approach towards celebrating International Day of Persons with Disabilities which is falling on December 3rd, 2021

Government of Telangana through Telangana State Innovation Cell (TSIC), Women & Child Development, and Welfare of Senior Citizens, will be acknowledging, and recognising Innovators and Entrepreneurs who have developed solutions in the space of Assistive Technology.

The program is divided into two parts:

- 1) Competition for College Students of Telangana
- 2) Showcase Opportunity for Assistive Technology Startups across India

Students from Telangana/Startups across India are allowed to submit the innovation under the below themes:

- 1) Visual Impairment
- 2) Development and Cognitive Disabilities
- 3) Locomotor Disability
- 4) Speech and Hearing Impairment
- 5) Senior Citizens

**madhuribayya.eee@gcet.edu.in** Switch account

 Draft saved

The name and photo associated with your Google account will be recorded when you upload files and submit this form. Only the email you enter is part of your response.

Any files that are uploaded will be shared outside of the organization they belong to.

\* Required

 Request edit access

Cheeraj (M), Keesara (M), Medchal Dist.(TS)-501 301.  
PRINCIPAL  
Geethanjali College of Engg. and Tech.





**TSIC**  
అంటిండా ఇన్నోవేటర్

Department for Welfare  
of Disabled and  
Senior Citizens



# Telangana Assistive Technology Summit 2.0

## CERTIFICATE OF APPRECIATION

AUTOMOTIVE WHEELS PVT LTD

Showcased the innovation titled

E - Wheels

at The Assistive Technology Exhibition 2021 held at  
Muffakham Jah College, organized by Government of Telangana on 4<sup>th</sup> Jan 2022.  
Your hardwork and achivement will be cherished.

**SRI JAYESH RANJAN, IAS**

Principal Secretary,  
ITE&C Department  
Government of Telangana

**Dr. Shanta Thoutam**  
Chief Innovation Officer,  
Government of Telangana

PRINCIPAL  
Geethanjali College of Engg. and Tech.  
Cheeryal (V), Keerasa (M), Medchal Dist. (R.S.)-501 301.





Geethanjali College of Engg. and Tech.  
Bheerpal (9), Kuvana Hill, Marthalli Dist. (SS) 561 301

Page No. 23



**STATEMENT OF ACCOUNT**

STATE BANK OF INDIA  
CHERIYAL  
1-66, MAIN ROAD, CHERIYAL VILLAGE  
KEESARA MANDAL  
Branch Code : 20435  
Branch Phone : 285258  
IFSC:SBIN0020435  
MICR:500002422

**AUTOMOTIVE WHEELS PRIVATE LIMITED**

CABIN 3, SY. NO. 33 & 34, CHEIRYAL  
CHERIYAL  
KEESARA, MEDCHAL MALKAJIGIRI  
501301

**Account No. : 39856258459**  
**Product : CA-REGULAR-PUB-OTH-ALL-INR**  
**Currency : INR**

**Date :** 29/10/2021                      **Time :** 16:34:52

**E-mail :**

**Cleared Balance :**                      10,000.00Cr

**Uncleared Amount :**                      0.00

**+MOD Bal:**                              0.00

**Limit :**                                      0.00

**Drawing Power :**                      0.00

**Int. Rate :** 0.00 % p.a.

**Nominee Name :**

Statement From 01/08/2021 to 29/10/2021

**Page No. : 1**

Post Date	Value Date	Details	Chq.No.	Debit	Credit	Balance
		<b>BROUGHT FORWARD :</b>				<b>0.00</b>
21/10/21	21/10/21	DEP TFR UPI/CR/129413730165/ 4899356162093 AT 20435 CHERIYAL			5000.00	5000.00Cr
21/10/21	21/10/21	DEP TFR UPI/CR/129415173015/ 5099069162093 AT 20435 CHERIYAL			5000.00	10000.00Cr

Geethanjali College of Engg. and Tech.  
Cheriyal (V), Keesara (M), Medchal Dist.(T.S.)-501 301.

**CLOSING BALANCE :**

**10,000.00Cr**

**Statement Summary**

**Dr. Count 0                      Cr. Count 2                      10,000.00**





Welcome PUTTA GANESH [Sign out](#)

Controller General of Patents, Designs & Trade  
Marks  
G.S.T. Road, Guindy, Chennai-600032  
Tel No. (091)(044) 22502081-84 Fax No. 044 22502066  
E-mail: chennai-patent@nic.in  
Web Site: www.ipindia.gov.in



सत्यमेव जयते

G.A.R.6  
[See Rule 22(1)]  
RECEIPT

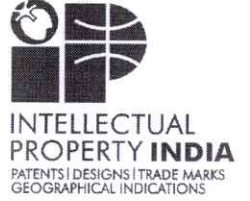

Docket No 67225

Date/Time 2021/08/03 10:17:46

To  
PUTTA GANESH

UserId: ganesh

Prometheus Patent Services Pvt Ltd, Plot No.  
34B, Sai Dwaraka Sinman, 1st Floor, HUDA  
Heights, MLA Colony, Near Lotus Pond,  
Road No. 12, Banjarahills, Hyderabad

**CBR Detail:**

Sr. No.	Ref. No./Application No.	App. Number	Amount Paid	C.B.R. No.	Form Name	Remarks
1	E-12/3042/2021/CHE	202141034823	12500	28393	FORM 9	
2	R20214026069	202141034823	20000	28393	FORM 18	---
3	202141034823	TEMP/E-1/39039/2021-CHE	8000	28393	FORM 1	AN ELECTRICAL AND ELECTRONIC ASSEMBLY TO AUTOMATE A WHEEL CHAIR FOR PHYSICALLY HANDICAPPED

TransactionID	Payment Mode	Challan Identification Number	Amount Paid	Head of A/C No
N-0000835915	Online Bank Transfer	0308210001580	40500.00	1475001020000001

Total Amount : ₹ 40500

Amount in Words: Rupees Forty Thousand Five Hundred Only

Received from PUTTA GANESH the sum of ₹ 40500 on account of Payment of fee for above mentioned Application/Forms.

\* This is a computer generated receipt, hence no signature required.

[Print](#)

[Home](#)

[About Us](#)

[Contact Us](#)

PRINCIPAL  
Geethanjali College of Engg. Tech.  
Chennai (C), Keasara (M), R.R. Dist. (A.P.) - 501 301

**FORM 1**  
**THE PATENTS ACT, 1970**  
**(39 of 1970)**  
**&**  
**THE PATENTS RULES, 2003**  
**APPLICATION FOR GRANT OF PATENT**  
**[See sections 7,54 & 135 and rule 20(1)]**

**(FOR OFFICE USE ONLY)**

Application No.: .....  
 Filing Date: .....  
 Amount of Fee Paid: .....  
 CBR No.: .....  
 Signature: .....

**I. APPLICANT(S):**

Sr.No.	Name	Nationality	Address	Country	State
1	Geethanjali College of Engineering and Technology	India	Geethanjali college of engineering and technology, Cheeryal (V), keesara(M), Medchal-501301, Telangana, India	India	Telangana
2	Masadi Prashanth Kumar	India	Assistant Professor, Department of Electrical and Electronics Engineering, Geethanjali College of Engineering and Technology, Cheeryal (V), keesara(M), Medchal-501301, Telangana, India	India	Telangana
3	Dr. Anil Kumar Puppala	India	Professor, Department of Electrical and Electronics Engineering, Geethanjali College of Engineering and Technology, Cheeryal	India	Telangana

**PRINCIPAL**  
 Geethanjali College of Engg. Tech.  
 Cheeryal (V), Keesara (M), R.R. Dist. (A.P.) - 501 301.



			Engineering and Technology, Cheeryal (V), keesara(M), Medchal-501301, Telangana, India		
3	Dr. Madhuri Bayya	India	Associate Professor, Department of Electrical and Electronics Engineering, Geethanjali College of Engineering and Technology, Cheeryal (V), keesara(M), Medchal-501301, Telangana, India	India	Telangana
4	Chinmay ranjan nayak	India	Alumni, Department of Electrical and Electronics Engineering, Geethanjali College of Engineering and Technology, Cheeryal (V), keesara(M), Medchal-501301, Telangana, India	India	Telangana
5	Boyannagari Rakesh	India	Alumni, Department of Electrical and Electronics Engineering, Geethanjali College of Engineering and Technology, Cheeryal (V),	India	Telangana

  
**PRINCIPAL**  
 Geethanjali College of Engg. Tech.  
 (V), Keesara (M), P. R. Dist. (A.P.) - 501301-



Number

**6. PARTICULARS FOR FILING PATENT COOPERATION TREATY (PCT) NATIONAL PHASE APPLICATION:**

International Application Number	International Filing Date as Allotted by the Receiving Office
PCT//	

**7. PARTICULARS FOR FILING DIVISIONAL APPLICATION**

Original (first) Application Number	Date of Filing of Original (first) Application

**8. PARTICULARS FOR FILING PATENT OF ADDITION:**

Main Application / Patent Number:	Date of Filing of Main Application

**9. DECLARATIONS:**

**(i) Declaration by the inventor(s)**

I/We, Masadi Prashanth Kumar, Dr. Anil Kumar Puppala, Dr. Madhuri Bayya, Chinmay ranjan nayak, Boyannagari Rakesh, Kadari sharan yadav, L Akhila, is/are the true & first inventor(s) for this invention and declare that the applicant(s) herein is/are my/our assignee or legal representative.

(a) Date: 30<sup>th</sup> July, 2021

(b) Signature(s) of the inventor(s): .....

(c) Name(s): Masadi Prashanth Kumar.....

Dr. Anil Kumar Puppala.....

Dr. Madhuri Bayya.....

Chinmay ranjan nayak.....

Boyannagari Rakesh.....

Kadari sharan yadav.....

L Akhila.....

**(ii) Declaration by the applicant(s) in the convention country**

I/We, the applicant(s) in the convention country declare that the applicant(s) herein is/are my/our assignee or legal representative.

(a) Date: ----

(b) Signature(s) : .....

(c) Name(s) of the singnatory: Geethanjali College of Engineering and Technology, Masadi Prashanth Kumar, Dr. Anil Kumar Puppala, Dr. Madhuri Bayya



**FORM 2**  
**THE PATENT ACT 1970**  
**(39 of 1970)**  
**&**  
**The Patents Rules, 2003**  
**COMPLETE SPECIFICATION**  
**(See section 10 and rule 13)**

**1. TITLE OF THE INVENTION:**

**“AN ELECTRICAL AND ELECTRONIC ASSEMBLY TO AUTOMATE A  
WHEEL CHAIR FOR PHYSICALLY HANDICAPPED”**

**2. APPLICANT(S):**

**Name** : **Geethanjali College of Engineering and Technology**  
**Address** : Geethanjali college of engineering and technology,  
Cheeryal (V), keesara(M), Medchal-501301, Telangana,  
India  
**Nationality** : Indian

**Name** : **Masadi Prashanth Kumar**  
**Address** : Assistant Professor, Department of Electrical and  
Electronics Engineering, Geethanjali College of  
Engineering and Technology, Cheeryal (V), keesara(M),  
Medchal-501301, Telangana, India  
**Nationality** : Indian

**Name** : **Dr. Anil Kumar Puppala**  
**Address** : Professor, Department of Electrical and Electronics  
Engineering, Geethanjali College of Engineering and  
Technology, Cheeryal (V), keesara(M), Medchal-501301,  
Telangana, India.  
**Nationality** : Indian

#### 4. DESCRIPTION:

##### FIELD OF INVENTION

The current invention is an electrical and electronic assembly to automate a wheel chair for physically handicapped. The design of the chair is made in such a way that it drives automatically to help differently abled people to move with ease unlike the one with manual crutches. It is an assembly of electrical and electronic components where a frame of two rear wheels fitted to a shaft is used. The wheel movements are facilitated by DC motors. Whenever the motor shaft rotates then the gear starts rotating and thus the wheels start moving. The electrical wheelchair has a potential of driving a pay load of hundred Kgs. and also designed with low cost which can be affordable by all. Significant research on the existing models and their modus operandi has led to useful insights for designing the current invention. It has micro controller, DC motor and battery based power supply along with an operating interface. It has a micro controller that plays crucial role in controlling the automatic wheel chair. It has pre-determined modus operandi that facilitates appropriate control of the invention. It has provision for two batteries of 12V, 7A. The micro controller has interface that controls two motor drivers. The motor drivers in turn interface with two motors. These are 24V DC motors configured with: Output: 250 Watt, RPM (after Reduction) – 300, Full load current – 13.4A, No load Current – 2.2A, Torque Constant – 8 N.m (80 kg-cm), Torque stall – 40 N.m (400 kg-cm), Sprocket: 9Tooth only fits #410 bicycle chains, for Chain Size: Pitch 0.5 inch, Roller Diameter 0.3 inch and Roller Width 0.16 inch. The stakeholders include differently abled people, charity organizations, governments, NGO organizations, wheel chair manufacturers, researchers and academia.

##### BACKGROUND OF THE INENTION

In spite of the recent innovations in the field of inventions for differently abled people, it is indispensable to consider improvements and also cost-effective approaches. Physically handicapped people cannot afford to have a wheel chair

PRINCIPAL  
Goethanjali College of Engg. Tech.  
Cheerayal (V), Kasarla (M), R.E. Dist. (A.P.) - 501 006



3] Another object of the present invention to have support for appropriate configurations that are based on the insights made on the literature pertaining to existing models.

4] Another object of the present invention is to have a unique software developed using C++ to have an embedded module that is used to have controlling functionality. 5] Another important object of the present invention is to have a procedure that has provision to have smooth interface between the user and the automated wheel chair.

6] Another object of the present invention is to have an integration mechanism that seamlessly facilitates smooth functioning of the components involved in the system.

7] Yet another object of the present invention is to a cost effective and efficient solution to physically handicapped people to have an automated wheel chair that bestows plenty of benefits when compared with manual wheel chair.

### **STATEMENT OF THE INVENTION**

The present invention titled "An Electrical and Electronic Assembly to Automate a Wheel Chair for Physically Handicapped" an electrical and electronic assembly to automate a wheel chair for physically handicapped. The design of the chair is made in such a way that it drives automatically to help differently abled people to move with ease unlike the one with manual crutches. It is an assembly of electrical and electronic components where a frame of two rear wheels fitted to a shaft is used. The components include Arduino UNO used as micro controller, 24V DC Motor, Batter 24V, 7 Amps Lead acid, Joystick for user interface, Motor drivers (BTS7960), Wheels, free wheel and final kit. The components used in the wheel chair are chosen based on the research carried out on the existing models. The components are chosen to make the wheel chair cost effective without compromising its intended functionality. The micro controller controls other

and their modus operandi has led to useful insights for designing the current invention. It has micro controller, DC motor and battery based power supply along with an operating interface. The current invention is illustrated with the help of many drawings given below.

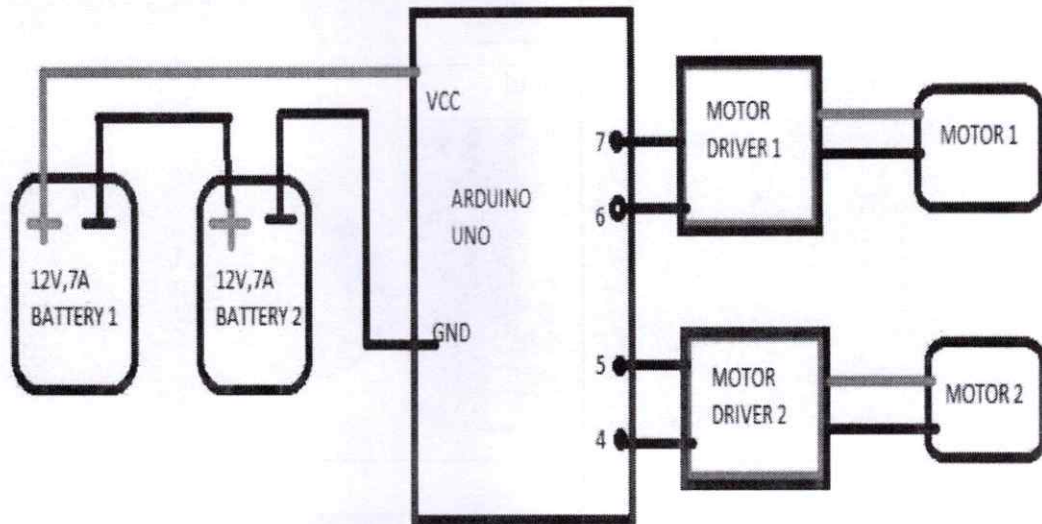

**Figure 1: Illustrates the block diagram of the current invention to have an automated wheel chair**

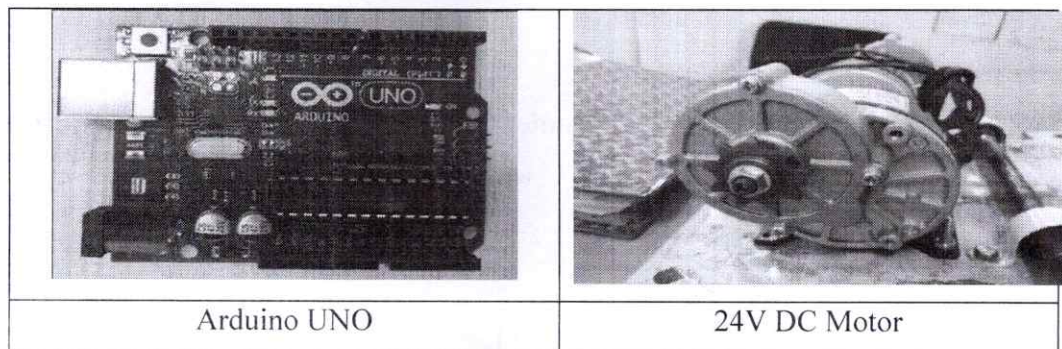



Microcontroller	Arduino Uno
Operating Voltage	1.8-5.5V
Input voltage for battery chargers	230V
Motor	24V DC
Battery	12V,7AMPS lead acid battery
Joystick	Aurdino interfacing electronic joystick
Wheels	Eight inches tube type
Motor driver	BTS7960
Software Used	C++
Connecting wires	Jumper wires

**Figure 3: Illustrates the specifications of the equipment used in the wheel chair**

PRINCIPAL  
 Geethanjali College of Engg. Tech.  
 Hooverville, Nagesara (M), R.R. Dist. (A.P.) - 501 207

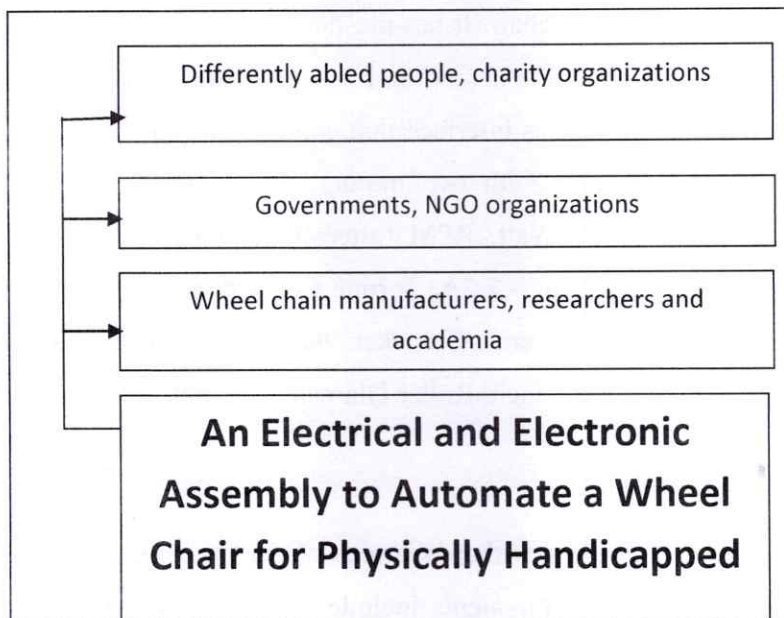

**Figure 5: Stakeholders for which the invention is beneficial**

**DETAILED DESCRIPTION OF DRAWINGS**

The current invention is an electrical and electronic assembly to automate a wheel chair for physically handicapped. The design of the chair is made in such a way that it drives automatically to help differently abled people to move with ease unlike the one with manual crutches. It is an assembly of electrical and electronic components where a frame of two rear wheels fitted to a shaft is used. The wheel movements are facilitated by DC motors. Whenever the motor shaft rotates then the gear starts rotating and thus the wheels start moving. The electrical wheelchair has a potential of driving a pay load of hundred Kgs. and also designed with low cost which can be affordable by all. Significant research on the existing models and their modus operandi has led to useful insights for designing the current invention. It has micro controller, DC motor and battery based power supply along with an operating interface. The diagrams provided in the previous section are described in detail in this section.

Referring to Figure 1, it illustrates the block diagram of the current invention to have an automated wheel chair. It has a micro controller that plays crucial role in



Referring to Figure 4, it illustrates the physical appearance of the designed when chair. The physical appearance is found to have high quality equipment that facilitates a physically handicapped person to operate wheel chair for himself without external assistance. When compared with the state of the art chairs, it is designed to have better control over the chair, automated movement based on the user's friendly interface. It is based on the design principles that meet dual goals of the electric chair such that it is both cost effective and efficient in serving the differently abled persons.

Referring to Figure 5, it illustrates the stakeholders for which the current invention is beneficial. The stakeholders include differently abled people, charity organizations, governments, NGO organizations, wheel chair manufacturers, researchers and academia.



PRINCIPAL  
Gouthanjali College of Engg. Techn.  
Sreeyud (Y), Keonjore (M), R.R. Dist. (A.P.) - 501 307

## 7. ABSTRACT

The current invention is an electrical and electronic assembly to automate a wheel chair for physically handicapped. The design of the chair is made in such a way that it drives automatically to help differently abled people to move with ease unlike the one with manual crutches. It is an assembly of electrical and electronic components where a frame of two rear wheels fitted to a shaft is used. The wheel movements are facilitated by DC motors. Whenever the motor shaft rotates then the gear starts rotating and thus the wheels start moving. The electrical wheelchair has a potential of driving a pay load of hundred Kgs. and also designed with low cost which can be affordable by all. Significant research on the existing models and their modus operandi has led to useful insights for designing the current invention. It has micro controller, DC motor and battery based power supply along with an operating interface. This invention benefits many stakeholders such as differently abled people, charity organizations, governments, NGO organizations, wheel chair manufacturers, researchers and academia.



PRINCIPAL  
Geethanjali College of Engg. Tech.  
Kessara (M), R.R. Dist. (A.P.) - 501 301



FORM 9  
THE PATENTS ACT, 1970  
(39 of 1970)

&  
The Patents Rules, 2003  
REQUEST FOR PUBLICATION  
[See section 11A(2) and rule 24A]

We,

**Name** : Geethanjali College of Engineering and Technology  
**Address** : Geethanjali college of engineering and technology, Cheeryal (V),  
keesara(M), Medchal-501301, Telangana, India  
**Nationality** : Indian  
**Name** : Masadi Prashanth Kumar  
**Address** : Assistant Professor, Department of Electrical and Electronics  
Engineering, Geethanjali College of Engineering and Technology,  
Cheeryal (V), keesara(M), Medchal-501301, Telangana, India  
**Nationality** : Indian  
**Name** : Dr. Anil Kumar Puppala  
**Address** : Professor, Department of Electrical and Electronics Engineering,  
Geethanjali College of Engineering and Technology, Cheeryal (V),  
keesara(M), Medchal-501301, Telangana, India.  
**Nationality** : Indian  
**Name** : Dr. Madhuri Bayya  
**Address** : Associate Professor, Department of Electrical and Electronics  
Engineering, Geethanjali College of Engineering and Technology,  
Cheeryal (V), keesara(M), Medchal-501301, Telangana, India  
**Nationality** : Indian

hereby request for early publication of our application for Patent of the invention titled “An  
Electrical and Electronic Assembly to Automate a Wheel Chair for Physical” under  
section 11A(2) of the Act.

Dated this July 30, 2021

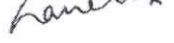
Authorized Patent Agent Signature:   
Authorized Patent Agent Name: **PUTTA GANESH**  
(IN/PA/2933)

To,  
The Controller of Patent  
The Patent Office, at Chennai

**PRINCIPAL**  
Geethanjali College of Engg. Tech.  
Cheeryal (V), Keesara (M), R.R. Dist. (A.P.) - 501301

HYDERABAD  
S.L.NO. 02/2006  
H.NO.6-3-392,R.L.NO.....  
BEHIND PUNJAGITTA POLICE STATION  
HYDERABAD  
LICENCE NO. 12/2006



10738

193825

DEPARTMENT

MAR 24 2021

2000 2000 2000 2000 2000 2000

17:49

R.0000100 PB5553

NON-JUDICIAL  
STAMP DUTY

TELANGANA

**FORM 26**  
**THE PATENTS ACT, 1970**  
**(39 of 1970)**

**&**  
**THE PATENTS RULES, 2003**

**FORM FOR AUTHORISATION OF A PATENT AGENT IN A MATTER OR**  
**PROCEEDING UNDER THE ACT**  
(See Section 127 and 132; and rule 135)

We,

**Name** : **Geethanjali College of Engineering and Technology**

**Address** : Geethanjali college of engineering and technology, Cheeryal (V),  
keesara(M), Medchal-501301, Telangana, India

**Nationality** : Indian

**Name** : **Mr. Masadi Prashanth Kumar**

**Address** : Assistant Professor, Department of Electrical and Electronics Engineering,  
Geethanjali College of Engineering and Technology, Cheeryal (V),  
keesara(M), Medchal-501301, Telangana, India

**Nationality** : Indian

**Name** : **Dr. Anil Kumar Puppala**

**Address** : Professor, Department of Electrical and Electronics Engineering,  
Geethanjali College of Engineering and Technology, Cheeryal (V),  
keesara(M), Medchal-501301, Telangana, India.

**Nationality** : Indian

**Name** : **Dr. Madhuri Bayya**

**Address** : Associate Professor, Department of Electrical and Electronics Engineering,  
Geethanjali College of Engineering and Technology, Cheeryal (V),  
keesara(M), Medchal-501301, Telangana, India

**Nationality** : Indian

1. R.V.
2. [Signature]
3. [Signature]
4. Madhuri B

**PRINCIPAL**  
Geethanjali College of Engg. Tech.  
Cheeryal (V), Keesara (M), R.R. Dist. (A.P.) - 501 301



# LAKSHMI NALLAMILLI & CO

Chartered Accountants

8-3-318/11, # 204, Vishnu Nivas, Jaya Prakash Nagar, Yella Reddy Guda, Hyderabad - 500 073

PAN : AAIFL3897Q

GSTIN : 36AAIFL3897Q1ZA

## TAX INVOICE

Invoice No : LNCO / 68 /2021-22

Date : 30/10/2021

To,  
AUTOMOTIVE WHEELS PRIVATE LIMITED  
HYDERABAD

PARTICULARS	HSN CODE	AMOUNT IN Rs.
<b>NATURE OF SERVICE</b>		
DIR-3 kyc Form Filing Charges	9982	3,000
INC-20A Form Filing charges		1,000
		<hr/>
		4,000
CGST@9%		360
SGST@9%		360
<b>Reimbursement of expenses</b>		
INC 20A Challan		2000
(Rupees Six thousand seven hundred and twenty rupees Only)		
<b>TOTAL</b>		<b>6,720</b>

### Bank account details

State Bank of India  
Sanjeeva Reddy Nagar Branch  
A/c.No.: 38739554878  
IFS Code: SBIN0020308

If you have any questions concerning this invoice , contact 040-48575577

THANK YOU FOR YOUR BUSINESS!

PRINCIPAL

Beethanjali College of Engg. and Tech.  
Cheeryal (V), Kaesara (M), Medchal Dist.(T.S.)-501 301.

# LAKSHYAM CONSULTANCY SERVICES

PAN : AAHFL2795C

8-3-318/11, # 204, Vishnu Nivas, Jaya Prakash Nagar, Yella Reddy Guda, Hyderabad - 500 073

## INVOICE

Invoice No : LCS / 21 /2020-21

Date :31.03.2021

To,  
THEJA EDUCATIONAL SOCIETY  
CABIN 2 SY. NO. 33&34, KEESARA ,TELANGANA 501301,  
RANGAREDDY DISTRICT

PARTICULARS	AMOUNT IN Rs.
Reimbursement of expenses for Digital signature certificates Incorporation challans	14000 4953
(Rupees eighteen Thousand nine hundred fifty three Only)	
<b>TOTAL</b>	<b>18,953</b>

### Bank account details

State Bank of India  
Yousufguda Branch  
A/c.No.: 37317790723  
IFS Code: SBIN0011662

THANK YOU FOR YOUR BUSINESS!

PRINCIPAL

Geethanjali College of Engg. and Tech  
(M), Keesara (M), Medchal Dist., Telangana



# LAKSHYAM CONSULTANCY SERVICES

PAN : AAHFL2795C

8-3-318/11, # 204, Vishnu Nivas, Jaya Prakash Nagar, Yella Reddy Guda, Hyderabad - 500 073

## INVOICE

Invoice No : LCS / 20 /2020-21

Date :31.03.2021

To,  
THEJA EDUCATIONAL SOCIETY  
CABIN 2 SY. NO. 33&34, KEESARA ,TELANGANA 501301,  
RANGAREDDY DISTRICT

PARTICULARS	AMOUNT IN Rs.
Company incorporations fees Advance  (Rupees Thirty Thousand Only)	45,000 60,000 30000
<b>TOTAL</b>	<b>30,000</b>

### Bank account details

State Bank of India  
Yousufguda Branch  
A/c.No.: 37317790723  
IFS Code: SBIN0011662

THANK YOU FOR YOUR BUSINESS!

*Snb*

**PRINCIPAL**  
Geethanjali College of Engg. and Tech.  
Cheruvu (V), Keesara (M), Medchal Dist.(T.S.)-501 301

*pay 45 k total*

*[Signature]*



Anil &lt;apuppala@gmail.com&gt;

## Re: Setting up & funding of Startups - Strategy

1 message

**Roopali JM** <roopalijm@yahoo.com>

Fri, Mar 19, 2021 at 3:36 PM

To: Ravinder Reddy <greddy1962@yahoo.co.in>

Cc: "apuppala@gcet.edu.in" <apuppala@gcet.edu.in>, "apuppala@gmail.com" <apuppala@gmail.com>, "caroopali@Inco.in" <caroopali@Inco.in>, "caashakiran@Inco.in" <caashakiran@Inco.in>, "nlakshmica@Inco.in" <nlakshmica@Inco.in>

Sir,

As per our telecon, we are going ahead with formation of private limited companies. Our professional charges would be Rs.20,000/- per company, The expenditure for digital signatures, stamping and fee payable to ROC would be billed separately on actuals, this would be approximately Rs.5000/- per company.

Mr. Anil just now communicated that three companies need to be incorporated. We request you to kindly provide Rs.30,000/- as advance towards these works. The advance can be paid to

Lakshyam consultancy services  
SBI acct no: 37317790723  
Yousufguda branch  
Ifsc code: SBIN0011662

I request you to provide all the documents immediately. Initially the below mentioned details are needed and the detailed list will be shared very shortly.

1. proposed name of the company - Three - in the order of preference
2. Names of the proposed shareholders - Minimum two - it is desirable to maintain at two only at this point of time
3. Email id of the shareholders
4. Mobile number of the shareholders
5. Passport size photo of the shareholders
6. adhar card copy of the shareholders - front & back - must have complete date of birth and must be linked to mobile
7. PAN card copy of the shareholders

Thanks & regards,  
Roopali J  
Chartered Accountant  
9949869992

On Thursday, 18 March, 2021, 05:48:56 pm IST, Roopali JM <roopalijm@yahoo.com> wrote:

Sir,

We met Mr. Anil Puppala and had detailed discussion. The gist of the discussion is as follows:

### Current Scenario

The Society currently has in house incubation centre through which the students are encouraged to take up projects. The promising and scalable projects are desired to be promoted further. Two such projects are identified and these need to be registered before 31st March also for listing under ARIAA scheme.

Guidance sought on new startup entities registration to be done under either of the following legal forms

1. MSME registered-Commercial Unit with GST no
2. Private Limited
3. Limited Liability Partnership (LLP)
4. One Person Company
5. Registered Partnership

Out of the above, the first one is sole proprietorship. Under this form only one Individual can be owner of the entity wherein the personal assets of the Individual will be exposed to all the risks as there will not be any differentiation made. Hence this form is not advisable

Second, third and fourth options are under the purview of Ministry of Corporate Affairs. All of these offer limited liability benefit. Amongst these, the second is advisable for the startup entity as multiple owners can be there as well as this is most preferred form by the investors either angel investors or Venture Capitalists. But these come with lot of compliances.

Fifth form is normal partnership firm which is governed by Registrar of Firms and not preferred by investors.

<https://mail.google.com/mail/u/0?ik=5328159e11&view=pt&search=all&permthid=thread-f%3A1694572196387751137%7Cmsg-f%3A16946543960750...> 1/2

*Shre*

PRINCIPAL  
Geethanjali College of Engg. and Tech.  
Cheerlyal (V), Keesara (M), Medchal Dist (T.S.)-501 001.



**Proposed structure for arranging the funding for the startups:**

The society being a non profitable entity itself, cannot fund the startups directly. It can rather float a non profitable organization, preferably a section 8 company to carry out these incubation activities. The objects and by-laws of the society need to be checked for this purpose.

The Section 8 company can then fund the startup and have a share in the ownership of the startup's. Once the startups have grown and get further funding, the section 8 company can go for exit route at proper price and the amounts earned can be further used for funding other startups

**The desirable route and the stop gap arrangement to meet the deadline of 31st March for the proposed projects:**

As stated above, the private limited company formation is only desirable as the students and faculties who are seriously working on the projects can be made owners. Besides the section 8 company can also hold a stake in it for supporting purposes and also to have control over them. As the section 8 company is not yet in existence, we can add this part later. This involves giving KYC documents, other papers to be arranged immediately to register them on the MCA portal as private limited company. We can definitely try to achieve this if proposed shareholders are identified, their KYC documents are provided to us by tom.

If the above is not feasible in such short span of time, as we are already on 18th March today, in order to meet the deadline of 31st, only for these two projects, we can apply only for GST registration (this would be option one in the above list) and then take MSME registration. Pl bear in mind that GST registration also takes around ten days of time from the time all the documents are provided and uploaded as Government has recently increased the window for processing by the department.

Therefore, it is requested to convey your decision for further course of action by us.

**Role by Lakshmi Nallamilli & Co, Chartered Accountants**

We are a group of six Chartered Accountants supported by other professionals and staff engaged in providing financial services. Our main office is located at Ameerpet and branch office is at Karimnagar. We can provide all the advisory services right from structuring to regular registration services. We can also help all the startup's in maintaining regular compliance with MCA, IT and GST departments by filing various returns. Further this CA's among us, are also registered valuers and are engaged conducting valuations for arranging funding from angel investors for promising and upcoming startup's. We also can help in arranging bank funding if needed.

I am herewith attaching profile of our firm for your ready reference. Also request you to let us know which registration to be initiated so that we send the documents required list and take it forward immediately from thereon.

Thanks & regards,  
Roopali J  
Chartered Accountant  
9949869992

*Snb*

PRINCIPAL  
Geethanjali College of Engg and Tech  
Cheerai (V), Keesara (M), Medchal Dist.(L.S.)-501 301

# LAKSHMI NALLAMILLI & CO

Chartered Accountants

8-3-318/11, # 204, Vishnu Nivas, Jaya Prakash Nagar, Yella Reddy Guda, Hyderabad - 500 073

PAN : AAIFL3897Q

GSTIN : 36AAIFL3897Q1ZA

## TAX INVOICE

Invoice No : LNCO / 70 /2021-22

Date : 30/10/2021

To,  
ZWEIRAD ELECTRIC PRIVATE LIMITED  
HYDERABAD

ARTICULARS	HSN CODE	AMOUNT IN Rs.
<b>NATURE OF SERVICE</b>		
DIR-3 kyc Form Filing Charges	9982	4,500
INC-20A Form Filing charges		1,000
CGST@9%		5,500
SGST@9%		495
		495
<b>Reimbursement of expenses</b>		
INC 20A Challan		2000
(Rupees Eight thousand four hundred and ninety rupees Only)		
<b>TOTAL</b>		<b>8,490</b>

### Bank account details

State Bank of India  
Sanjeeva Reddy Nagar Branch  
A/c.No.: 38739554878  
IFS Code: SBIN0020308

If you have any questions concerning this invoice, contact **Geethanjali G. and Tech.**  
**PRINCIPAL**  
Cheerla (V), Keesara (M), Medchal Dist.(T.S.)-501 301.

**THANK YOU FOR YOUR BUSINESS!**



# LAKSHMI NALLAMILLI & CO

Chartered Accountants

8-3-318/11, # 204, Vishnu Nivas, Jaya Prakash Nagar, Yella Reddy Guda, Hyderabad - 500 073

PAN : AAIFL3897Q

GSTIN : 36AAIFL3897Q1ZA

## TAX INVOICE

Invoice No : LNCO / 69 /2021-22

Date : 30/10/2021

To,  
RETRO-E VEHICLES PRIVATE LIMITED  
HYDERABAD

ARTICULARS	HSN CODE	AMOUNT IN Rs.
<b>NATURE OF SERVICE</b>		
DIR-3 kyc Form Filing Charges	9982	3,000
INC-20A Form Filing charges		1,000
CGST@9%		4,000
SGST@9%		360
		360
<b>Reimbursement of expenses</b>		
INC 20A Challan		2000
(Rupees Six thousand seven hundred and twenty rupees Only)		
<b>TOTAL</b>		<b>6,720</b>

### Bank account details

State Bank of India  
Sanjeeva Reddy Nagar Branch  
A/c.No.: 38739554878  
IFS Code: SBIN0020308

If you have any questions concerning this invoice , contact 040-48575577

**THANK YOU FOR YOUR BUSINESS!**

**PRINCIPAL**  
Geethanjali College of Engg. and Tech.  
Cheeryal (V), Keesara (M), Medchal Dist.(T.S.)-501 301.

# LAKSHYAM CONSULTANCY SERVICES

PAN : AAHFL2795C

8-3-318/11, # 204, Vishnu Nivas, Jaya Prakash Nagar, Yella Reddy Guda, Hyderabad - 500 073

## INVOICE

Invoice No : LCS / 21 /2020-21

Date :31.03.2021

To,  
THEJA EDUCATIONAL SOCIETY  
CABIN 2 SY. NO. 33&34, KEESARA ,TELANGANA 501301,  
RANGAREDDY DISTRICT

PARTICULARS	AMOUNT IN Rs.
Reimbursement of expenses for Digital signature certificates Incorporation challans  (Rupees eighteen Thousand nine hundred fifty three Only)	14000 4953
<b>TOTAL</b>	<b>18,953</b>

### Bank account details

State Bank of India  
Yousufguda Branch  
A/c.No.: 37317790723  
IFS Code: SBIN0011662

**THANK YOU FOR YOUR BUSINESS!**

  
**PRINCIPAL**  
Geethanjali College of Engg. and Tech.  
Cheeryal (V), Keesara (M), Medchal Dist.(T.S.)-501 301.



# LAKSHYAM CONSULTANCY SERVICES

PAN : AAHFL2795C

8-3-318/11, # 204, Vishnu Nivas, Jaya Prakash Nagar, Yella Reddy Guda, Hyderabad - 500 073

## INVOICE

Invoice No : LCS / 20 /2020-21

Date :31.03.2021

To,  
THEJA EDUCATIONAL SOCIETY  
CABIN 2 SY. NO. 33&34, KEESARA ,TELANGANA 501301,  
RANGAREDDY DISTRICT

PARTICULARS	AMOUNT IN Rs.
Company incorporations fees Advance  (Rupees Thirty Thousand Only)	60,000 30000
<b>TOTAL</b>	<b>30,000</b>

### Bank account details

State Bank of India  
Yousufguda Branch  
A/c.No.: 37317790723  
IFS Code: SBIN0011662

**THANK YOU FOR YOUR BUSINESS!**

  
**PRINCIPAL**  
Geethanjali College of Engg. and Tech.  
Cheeryal (V), Keesara (M), Medchal Dist.(T.S.)-501 301.



Geethanjali

Phones : 9182058186

9182058196

9182058198

E-mail : info@gcet.edu.in

Website: www.geethanjalinstitutions.com

# TEJA EDUCATIONAL SOCIETY

(Accredited by NBA, Approved by AICTE, New Delhi and Affiliated to JNTUH, Hyderabad)

Sy.No. 33 & 34, Cheeryal (V), Keesara (M), Medchal District. - 501 301.

## NO OBJECTION CERTIFICATE

TO WHOMSOEVER IT MAY CONCERN

I, G.Sridevi, President of Teja Educational Society, do hereby state the following:

Teja Educational Society owns CABIN 1, SY NO 33&34, CHERIYAL (V), KEESARA (M), RANGAREDDY DISTRICT -501301 and I being President of the said society do hereby state that we have no objection for using the said premises for the registered office purpose of VIDYUTH VAAHAN PRIVATE LIMITED with a rent to be mutually fixed by us and the said proposed company in due course.

For

TEJA EDUCATIONAL SOCIETY

For Teja Educational Society

President

President

G.SRIDEVI



PRINCIPAL

Geethanjali College of Engg. and Tech.  
Cheeryal (V), Keesara (M), Medchal Dist.(T.S.)-501 301.

*[Faint handwritten notes and stamps at the bottom right corner]*



**STATEMENT OF ACCOUNT**

STATE BANK OF INDIA

CHERIYAL

1-66, MAIN ROAD, CHERIYAL VILLAGE

KEESARA MANDAL

Branch Code : 20435

Branch Phone : 285258

IFSC:SBIN0020435

MICR:500002422

**ZWEIRAD ELECTRIC PRIVATE LIMITED**

CABIN 1, SY. NO. 33 &amp; 34, CHERIYAL

CHERIYAL

KEESARA,

501301

**Account No. : 39858504639****Product : CA-REGULAR-PUB-OTH-ALL-INR****Currency : INR****Date :** 29/10/2021**Time :** 16:31:21**E-mail :****Cleared Balance :**

10,000.00Cr

**Uncleared Amount :**

0.00

**+MOD Bal:**

0.00

**Limit :**

0.00

**Drawing Power :**

0.00

**Int. Rate :** 0.00 % p.a.**Nominee Name :**

Statement From 01/08/2021 to 29/10/2021

**Page No. : 1**

Post Date	Value Date	Details	Chq.No.	Debit	Credit	Balance
		<b>BROUGHT FORWARD :</b>				0.00
25/10/21	25/10/21	NEW BRANCH : = 20435 BY CLEARING	000001		4000.00	4000.00Cr
		HDF 500240002-0000				
29/10/21	29/10/21	DEP TFR UPI/CR/130214544610/ 5099169162090			3000.00	7000.00Cr
		AT 20435 CHERIYAL				
29/10/21	29/10/21	DEP TFR UPI/CR/130214573714/ 4693440162098			3000.00	10000.00Cr
		AT 20435 CHERIYAL				

CLOSING BALANCE :

PRINCIPAL  
Geethanjali College of Engg. and Tech.  
Cheeryal (V), Keesara (M), Medchal Dist.(T.S.)-501 301.

10,000.00Cr

**Statement Summary**

Dr. Count 0

Cr. Count 3

10,000.00



**STATEMENT OF ACCOUNT**

STATE BANK OF INDIA

CHERIYAL

1-66, MAIN ROAD, CHERIYAL VILLAGE

KEESARA MANDAL

Branch Code : 20435

Branch Phone : 285258

IFSC:SBIN0020435

MICR:500002422

**Account No. : 39856256825****Product : CA-REGULAR-PUB-OTH-ALL-INR****Currency : INR****RETRO E VEHICLES PRIVATE LIMITED**

CABIN 2, SY NO. 33 &amp; 34,

CHERIYAL

CHEIRYAL, KEESARA, MEDCHAL MALKAJIGIRI

501301

**Date :** 30/10/2021**Time :** 12:22:40**E-mail :****Cleared Balance :**

15,000.00Cr

**Uncleared Amount :**

0.00

**+MOD Bal:**

0.00

**Limit :**

0.00

**Drawing Power :**

0.00

**Int. Rate :** 0.00 % p.a.**Nominee Name :**

Statement From 01/08/2021 to 30/10/2021

**Page No. : 1**

Post Date	Value Date	Details	Chq.No.	Debit	Credit	Balance
		<b>BROUGHT FORWARD :</b>				<b>0.00</b>
25/10/21	25/10/21	BY CLEARING CAB 500015003-2108	210807		5000.00	5000.00Cr
25/10/21	25/10/21	BY CLEARING HDF 695240004-0000 SET HOLD = 5000.00 DELETE HOLD = 5000	000002		5000.00	10000.00Cr
30/10/21	30/10/21	DEP TFR UPI/CR/130333449180/ 4693588162090 AT 00001 KOLKATA BR			5000.00	15000.00Cr

Principal  
Geethanjali College of Engg. and Tech.  
Cheriyal (V), Keesara (M), Medchal Dist.(T.S.)-501 301.

CLOSING BALANCE :

15,000.00Cr

Statement Summary

Dr. Count 0

Cr. Count 3

15,000.00





\*Table  F as notified under schedule I of the companies Act, 2013 is applicable to the company

RETRO-E VEHICLES PRIVATE LIMITED

A COMPANY LIMITED BY SHARES

Check if not applicable	Check if altered	Article No	Description
			<b>Interpretation</b>
<input checked="" type="checkbox"/>	<input type="checkbox"/>	1	(1) In these regulations- (a) "the Act" means the Companies Act, 2013, (b) "the seal" means the common seal of the company. (2) Unless the context otherwise requires, words or expressions contained in these regulations shall bear the same meaning as in the Act or any statutory modification thereof in force at the date at which these regulations become binding on the company.
			<b>Share capital and variation of rights</b>
<input type="checkbox"/>	<input type="checkbox"/>	II 1	Subject to the provisions of the Act and these Articles, the shares in the capital of the company shall be under the control of the Directors who may issue, allot or otherwise dispose of the same or any of them to such persons, in such proportion and on such terms and conditions and either at a premium or at par and at such time as they may from time to time think fit.
<input type="checkbox"/>	<input type="checkbox"/>	2	(i) Every person whose name is entered as a member in the register of members shall be entitled to receive within two months after incorporation, in case of subscribers to the memorandum or after allotment or within one month after the application for the registration of transfer or transmission or within such other period as the conditions of issue shall be provided,- (a) one certificate for all his shares without payment of any charges; or (b) several certificates, each for one or more of his shares, upon payment of twenty rupees for each certificate after the first. (ii) Every certificate shall be under the seal and shall specify the shares to which it relates and the amount paid-up thereon. (iii) In respect of any share or shares held jointly by several persons, the company shall not be bound to issue more than one certificate, and delivery of a certificate for a share to one of several joint holders shall be sufficient delivery to all such holders
<input type="checkbox"/>	<input type="checkbox"/>	3	(i) If any share certificate be worn out, defaced, mutilated or torn or if there be no further space on the back for endorsement of transfer, then upon production and surrender thereof to the company, a new certificate may be issued in lieu thereof, and if any certificate is lost or destroyed then upon proof thereof to the satisfaction of the company and on execution of such indemnity as the company deem adequate, a new certificate in lieu thereof shall be given. Every certificate under this Article shall be issued on payment of twenty rupees for each certificate. (ii) The provisions of Articles (2) and (3) shall mutatis mutandis apply to debentures of the company.
<input type="checkbox"/>	<input type="checkbox"/>	4	Except as required by law, no person shall be recognised by the company as holding any share upon any trust, and the company shall not be bound by, or be compelled in any way to recognise (even when having notice thereof) any equitable, contingent, future or partial interest in any share, or any interest in any fractional part of a share, or (except only as by these regulations or by law otherwise provided) any other rights in respect of any share except an absolute right to the entirety thereof in the registered holder.
<input type="checkbox"/>	<input type="checkbox"/>	5	(i) The company may exercise the powers of paying commissions conferred by sub-section (6) of section 40, provided that the rate per cent or the amount of the commission paid or agreed to be paid shall be disclosed in the manner required by that section and rules made thereunder. (ii) The rate or amount of the commission shall not exceed the rate or amount prescribed in rules made under sub-section (6) of section 40.



<input type="checkbox"/>	<input type="checkbox"/>	17	(i) Any sum which by the terms of issue of a share becomes payable on allotment or at any fixed date, whether on account of the nominal value of the share or by way of premium, shall, for the purposes of these regulations, be deemed to be a call duly made and payable on the date on which by the terms of issue such sum becomes payable. (ii) In case of non-payment of such sum, all the relevant provisions of these regulations as to payment of interest and expenses, forfeiture or otherwise shall apply as if such sum had become payable by virtue of a call duly made and notified.
<input type="checkbox"/>	<input type="checkbox"/>	18	The Board- (a) may, if it thinks fit, receive from any member willing to advance the same, all or any part of the monies uncalled and unpaid upon any shares held by him; and (b) upon all or any of the monies so advanced, may (until the same would, but for such advance, become presently payable) pay interest at such rate not exceeding, unless the company in general meeting shall otherwise direct, twelve per cent per annum, as may be agreed upon between the Board and the member paying the sum in advance.
			<b>Transfer of shares</b>
<input type="checkbox"/>	<input type="checkbox"/>	19	(i) The instrument of transfer of any share in the company shall be executed by or on behalf of both the transferor and transferee. (ii) The transferor shall be deemed to remain a holder of the share until the name of the transferee is entered in the register of members in respect thereof.
<input type="checkbox"/>	<input type="checkbox"/>	20	The Board may, subject to the right of appeal conferred by section 58 decline to register- (a) the transfer of a share, not being a fully paid share, to a person of whom they do not approve; or (b) any transfer of shares on which the company has a lien.
<input type="checkbox"/>	<input type="checkbox"/>	21	The Board may decline to recognise any instrument of transfer unless- (a) the instrument of transfer is in the form as prescribed in rules made under sub-section (1) of section 56; (b) the instrument of transfer is accompanied by the certificate of the shares to which it relates, and such other evidence as the Board may reasonably require to show the right of the transferor to make the transfer; and (c) the instrument of transfer is in respect of only one class of shares.
<input type="checkbox"/>	<input type="checkbox"/>	22	On giving not less than seven days' previous notice in accordance with section 91 and rules made thereunder, the registration of transfers may be suspended at such times and for such periods as the Board may from time to time determine: Provided that such registration shall not be suspended for more than thirty days at any one time or for more than forty-five days in the aggregate in any year.
			<b>Transmission of shares</b>
<input type="checkbox"/>	<input type="checkbox"/>	23	(i) On the death of a member, the survivor or survivors where the member was a joint holder, and his nominee or nominees or legal representatives where he was a sole holder, shall be the only persons recognised by the company as having any title to his interest in the shares (ii) Nothing in clause (i) shall release the estate of a deceased joint holder from any liability in respect of any share which had been jointly held by him with other persons.
<input type="checkbox"/>	<input type="checkbox"/>	24	(i) Any person becoming entitled to a share in consequence of the death or insolvency of a member may, upon such evidence being produced as may from time to time properly be required by the Board and subject as hereinafter provided, elect, either- (a) to be registered himself as holder of the share; or (b) to make such transfer of the share as the deceased or insolvent member could have made. (ii) The Board shall, in either case, have the same right to decline or suspend registration as it would have had, if the deceased or insolvent member had transferred the share before his death or insolvency.
<input type="checkbox"/>	<input type="checkbox"/>	25	(i) If the person so becoming entitled shall elect to be registered as holder of the share himself, he shall deliver or send to the company a notice in writing signed by him stating that he so elects. (ii) If the person aforesaid shall elect to transfer the share, he shall testify his election by executing a transfer of the share. (iii) All the limitations, restrictions and provisions of these regulations relating to the right to transfer and the registration of transfers of shares shall be applicable to any such notice or transfer as aforesaid as if the death or insolvency of the member had not occurred and the notice or transfer were a transfer signed by that member.
<input type="checkbox"/>	<input type="checkbox"/>	26	A person becoming entitled to a share by reason of the death or insolvency of the holder shall be entitled to the same dividends and other advantages to which he would be entitled if he were the registered holder of the share, except that he shall not, before being registered as a member in respect of the share, be entitled in respect of it to exercise any right conferred by membership in relation to meetings of the company: Provided that the Board may, at any time, give notice requiring any such person to elect either to be registered himself or to transfer the share, and if the notice is not complied with within ninety days, the Board may thereafter withhold payment of all dividends, bonuses or other monies payable in respect of the share, until the requirements of the notice have been complied with.



			(b) any capital redemption reserve account; or (c) any share premium account.
			<b>Capitalisation of profits</b>
<input type="checkbox"/>	<input type="checkbox"/>	38	(i) The company in general meeting may, upon the recommendation of the Board, resolve- (a) that it is desirable to capitalise any part of the amount for the time being standing to the credit of any of the company's reserve accounts, or to the credit of the, profit and loss account, or otherwise available for distribution; and (b) that such sum be accordingly set free for distribution in the manner specified in clause (ii) amongst the members who would have been entitled thereto, if distributed by way of dividend and in the same proportions. (ii) The sum aforesaid shall not be paid in cash but shall be applied, subject to the provision contained in clause (iii), either in or towards- (A) paying up any amounts for the time being unpaid on any shares held by such members respectively; (B) paying up in full, unissued shares of the company to be allotted and distributed, credited as fully paid-up, to and amongst such members in the proportions aforesaid; (C) partly in the way specified in sub-clause (A) and partly in that specified in sub-clause (B); (D) A securities premium account and a capital redemption reserve account may, for the purposes of this regulation, be applied in the paying up of unissued shares to be issued to members of the company as fully paid bonus shares; (E) The Board shall give effect to the resolution passed by the company in pursuance of this regulation.
<input type="checkbox"/>	<input type="checkbox"/>	39	(i) Whenever such a resolution as aforesaid shall have been passed, the Board shall- (a) make all appropriations and applications of the undivided profits resolved to be capitalised thereby, and all allotments and issues of fully paid shares if any; and (b) generally do all acts and things required to give effect thereto. (ii) The Board shall have power- (a) to make such provisions, by the issue of fractional certificates or by payment in cash or otherwise as it thinks fit, for the case of shares becoming distributable in fractions; and (b) to authorise any person to enter, on behalf of all the members entitled thereto, into an agreement with the company providing for the allotment to them respectively, credited as fully paid-up, of any further shares to which they may be entitled upon such capitalisation, or as the case may require, for the payment by the company on their behalf, by the application thereto of their respective proportions of profits resolved to be capitalised, of the amount or any part of the amounts remaining unpaid on their existing shares; (iii) Any agreement made under such authority shall be effective and binding on such members.
			<b>Buy-back of shares</b>
<input type="checkbox"/>	<input type="checkbox"/>	40	Notwithstanding anything contained in these articles but subject to the provisions of sections 68 to 70 and any other applicable provision of the Act or any other law for the time being in force, the company may purchase its own shares or other specified securities.
			<b>General meetings</b>
<input type="checkbox"/>	<input type="checkbox"/>	41	All general meetings other than annual general meeting shall be called extraordinary general meeting.
<input type="checkbox"/>	<input type="checkbox"/>	42	(i) The Board may, whenever it thinks fit, call an extraordinary general meeting. (ii) If at any time directors capable of acting who are sufficient in number to form a quorum are not within India, any director or any two members of the company may call an extraordinary general meeting in the same manner, as nearly as possible, as that in which such a meeting may be called by the Board.
			<b>Proceedings at general meetings</b>
<input type="checkbox"/>	<input type="checkbox"/>	43	(i) No business shall be transacted at any general meeting unless a quorum of members is present at the time when the meeting proceeds to business. (ii) Save as otherwise provided herein, the quorum for the general meetings shall be as provided in section 103.
<input type="checkbox"/>	<input type="checkbox"/>	44	The chairperson, if any, of the Board shall preside as Chairperson at every general meeting of the company.
<input type="checkbox"/>	<input type="checkbox"/>	45	If there is no such Chairperson, or if he is not present within fifteen minutes after the time appointed for holding the meeting, or is unwilling to act as chairperson of the meeting, the directors present shall elect one of their members to be Chairperson of the meeting.
<input type="checkbox"/>	<input type="checkbox"/>	46	If at any meeting no director is willing to act as Chairperson or if no director is present within fifteen minutes after the time appointed for holding the meeting, the members present shall choose one of their members to be Chairperson of the meeting.
			<b>Adjournment of meeting</b>



<input type="checkbox"/>	<input type="checkbox"/>	61	The company may exercise the powers conferred on it by section 88 with regard to the keeping of a foreign register; and the Board may (subject to the provisions of that section) make and vary such regulations as it may think fit respecting the keeping of any such register.
<input type="checkbox"/>	<input type="checkbox"/>	62	All cheques, promissory notes, drafts, hundis, bills of exchange and other negotiable instruments, and all receipts for monies paid to the company, shall be signed, drawn, accepted, endorsed, or otherwise executed, as the case may be, by such person and in such manner as the Board shall from time to time by resolution determine.
<input type="checkbox"/>	<input type="checkbox"/>	63	Every director present at any meeting of the Board or of a committee thereof shall sign his name in a book to be kept for that purpose.
<input type="checkbox"/>	<input type="checkbox"/>	64	(i) Subject to the provisions of section 149, the Board shall have power at any time, and from time to time, to appoint a person as an additional director, provided the number of the directors and additional directors together shall not at any time exceed the maximum strength fixed for the Board by the articles. (ii) Such person shall hold office only up to the date of the next annual general meeting of the company but shall be eligible for appointment by the company as a director at that meeting subject to the provisions of the Act.
			<b>Proceedings of the Board</b>
<input type="checkbox"/>	<input type="checkbox"/>	65	(i) The Board of Directors may meet for the conduct of business, adjourn and otherwise regulate its meetings, as it thinks fit. (ii) A director may, and the manager or secretary on the requisition of a director shall, at any time, summon a meeting of the Board.
<input type="checkbox"/>	<input type="checkbox"/>	66	(i) Save as otherwise expressly provided in the Act, questions arising at any meeting of the Board shall be decided by a majority of votes. (ii) In case of an equality of votes, the Chairperson of the Board, if any, shall have a second or casting vote.
<input type="checkbox"/>	<input type="checkbox"/>	67	The continuing directors may act notwithstanding any vacancy in the Board; but, if and so long as their number is reduced below the quorum fixed by the Act for a meeting of the Board, the continuing directors or director may act for the purpose of increasing the number of directors to that fixed for the quorum, or of summoning a general meeting of the company, but for no other purpose.
<input type="checkbox"/>	<input type="checkbox"/>	68	(i) The Board may elect a Chairperson of its meetings and determine the period for which he is to hold office. (ii) If no such Chairperson is elected, or if at any meeting the Chairperson is not present within five minutes after the time appointed for holding the meeting, the directors present may choose one of their number to be Chairperson of the meeting.
<input type="checkbox"/>	<input type="checkbox"/>	69	(i) The Board may, subject to the provisions of the Act, delegate any of its powers to committees consisting of such member or members of its body as it thinks fit. (ii) Any committee so formed shall, in the exercise of the powers so delegated, conform to any regulations that may be imposed on it by the Board.
<input type="checkbox"/>	<input type="checkbox"/>	70	(i) A committee may elect a Chairperson of its meetings. (ii) If no such Chairperson is elected, or if at any meeting the Chairperson is not present within five minutes after the time appointed for holding the meeting, the members present may choose one of their members to be Chairperson of the meeting.
<input type="checkbox"/>	<input type="checkbox"/>	71	(i) A committee may meet and adjourn as it thinks fit. (ii) Questions arising at any meeting of a committee shall be determined by a majority of votes of the members present, and in case of an equality of votes, the Chairperson shall have a second or casting vote.
<input type="checkbox"/>	<input type="checkbox"/>	72	All acts done in any meeting of the Board or of a committee thereof or by any person acting as a director, shall, notwithstanding that it may be afterwards discovered that there was some defect in the appointment of any one or more of such directors or of any person acting as aforesaid, or that they or any of them were disqualified, be as valid as if every such director or such person had been duly appointed and was qualified to be a director.
<input type="checkbox"/>	<input type="checkbox"/>	73	Save as otherwise expressly provided in the Act, a resolution in writing, signed by all the members of the Board or of a committee thereof, for the time being entitled to receive notice of a meeting of the Board or committee, shall be valid and effective as if it had been passed at a meeting of the Board or committee, duly convened and held.
			<b>Chief Executive Officer, Manager, Company Secretary or Chief Financial Officer</b>
<input type="checkbox"/>	<input type="checkbox"/>	74	Subject to the provisions of the Act,- (i) A chief executive officer, manager, company secretary or chief financial officer may be appointed by the Board for such term, at such remuneration and upon such conditions as it may think fit; and any chief executive officer, manager, company secretary or chief financial officer so appointed may be removed by means of a resolution of the Board; (ii) A director may be appointed as chief executive officer, manager, company secretary or chief financial officer
<input type="checkbox"/>	<input type="checkbox"/>	75	A provision of the Act or these regulations requiring or authorising a thing to be done by or to a director and chief executive officer, manager, company secretary or chief financial officer shall not be satisfied by its being done by or to the same person acting both as director and as, or in place of, chief executive officer, manager, company secretary or chief financial officer.



			(iii) The liquidator may, with the like sanction, vest the whole or any part of such assets in trustees upon such trusts for the benefit of the contributories if he considers necessary, but so that no member shall be compelled to accept any shares or other securities whereon there is any liability.
			<b>Indemnity</b>
<input type="checkbox"/>	<input type="checkbox"/>	88	Every officer of the company shall be indemnified out of the assets of the company against any liability incurred by him in defending any proceedings, whether civil or criminal, in which judgment is given in his favour or in which he is acquitted or in which relief is granted to him by the court or the Tribunal.
<input checked="" type="checkbox"/>			<b>Others</b>
		89	<p>PRIVATE COMPANY The Company is a Private Company within the meaning of Section 2(68) of the Companies Act, 2013, and accordingly:</p> <p>(i) The right to transfer shares in the Company is restricted in the manner and to the extent herein after appearing;</p> <p>(ii) The number of members of the Company (exclusive of persons who are in the employment of the Company, and persons who having been formerly in the employment of the Company, were members of the Company while in the employment and have continued to be members after the employment ceased) shall be limited to two hundred; provided that for the purpose of this definition where two or more persons jointly hold one or more shares in the Company, the shall, be treated as a single member, and.</p> <p>(iii) prohibits any invitation to the public to subscribe for any securities of the company</p>

  
**PRINCIPAL**  
 Geethanjali College of Engg. and Tech.  
 Cheeryal (V), Keesara (M), Medchal Dist.(T.S.)-501 301.

\*Table  F as notified under schedule I of the companies Act, 2013 is applicable to the company

**AUTOMOTIVE WHEELS PRIVATE LIMITED**

**A COMPANY LIMITED BY SHARES**

Check if not applicable	Check if altered	Article No	Description
			<b>Interpretation</b>
<input type="checkbox"/>	<input checked="" type="checkbox"/>	I	<p>(1) In these regulations-</p> <p>(a) "the Act" means the Companies Act, 2013,</p> <p>(b) "the seal" means the common seal of the company.</p> <p>(2) Unless the context otherwise requires, words or expressions contained in these regulations shall bear the same meaning as in the Act or any statutory modification thereof in force at the date at which these regulations become binding on the company.</p> <p>(3) private company means a company having a minimum paid-up share capital as may be prescribed, and which by its articles, ?</p> <p>(i) restricts the right to transfer its shares;</p> <p>(ii) except in case of One Person Company, limits the number of its members to two Hundred: Provided that where two or more persons hold one or more shares in a company jointly, they shall, for the purposes of this clause, be treated as a single member: Provided further that?</p> <p>(A) persons who are in the employment of the company; and</p> <p>(B) persons who, having been formerly in the employment of the company, were members of the company while in that employment and have continued to be members after the employment ceased, shall not be included in the number of members; and</p> <p>(iii) Prohibits any invitation to the public to subscribe for any securities of the company.</p>
			<b>Share capital and variation of rights</b>
<input type="checkbox"/>	<input type="checkbox"/>	II 1	Subject to the provisions of the Act and these Articles, the shares in the capital of the company shall be under the control of the Directors who may issue, allot or otherwise dispose of the same or any of them to such persons, in such proportion and on such terms and conditions and either at a premium or at par and at such time as they may from time to time think fit.
<input type="checkbox"/>	<input type="checkbox"/>	2	<p>(i) Every person whose name is entered as a member in the register of members shall be entitled to receive within two months after incorporation, in case of subscribers to the memorandum or after allotment or within one month after the application for the registration of transfer or transmission or within such other period as the conditions of issue shall be provided,-</p> <p>(a) one certificate for all his shares without payment of any charges; or</p> <p>(b) several certificates, each for one or more of his shares, upon payment of twenty rupees for each certificate after the first.</p> <p>(ii) Every certificate shall be under the seal and shall specify the shares to which it relates and the amount paid-up thereon.</p> <p>(iii) In respect of any share or shares held jointly by several persons, the company shall not be bound to issue more than one certificate, and delivery of a certificate for a share to one of several joint holders shall be sufficient delivery to all such holders</p>
<input type="checkbox"/>	<input type="checkbox"/>	3	<p>(i) If any share certificate be worn out, defaced, mutilated or torn, or if there be no further space on the back for endorsement of transfer, then upon production and surrender thereof to the company, a new certificate may be issued in lieu thereof, and if any certificate is lost or destroyed then upon proof thereof to the satisfaction of the company and on execution of such indemnity as the company deem adequate, a new certificate in lieu thereof</p>



			shares. (iii) A call may be revoked or postponed at the discretion of the Board.
<input type="checkbox"/>	<input type="checkbox"/>	14	A call shall be deemed to have been made at the time when the resolution of the Board authorizing the call was passed and may be required to be paid by instalments.
<input type="checkbox"/>	<input type="checkbox"/>	15	The joint holders of a share shall be jointly and severally liable to pay all calls in respect thereof.
<input type="checkbox"/>	<input type="checkbox"/>	16	(i) If a sum called in respect of a share is not paid before or on the day appointed for payment thereof, the person from whom the sum is due shall pay interest thereon from the day appointed for payment thereof to the time of actual payment at ten per cent per annum or at such lower rate, if any, as the Board may determine. (ii) The Board shall be at liberty to waive payment of any such interest wholly or in part.
<input type="checkbox"/>	<input type="checkbox"/>	17	(i) Any sum which by the terms of issue of a share becomes payable on allotment or at any fixed date, whether on account of the nominal value of the share or by way of premium, shall, for the purposes of these regulations, be deemed to be a call duly made and payable on the date on which by the terms of issue such sum becomes payable. (ii) In case of non-payment of such sum, all the relevant provisions of these regulations as to payment of interest and expenses, forfeiture or otherwise shall apply as if such sum had become payable by virtue of a call duly made and notified.
<input type="checkbox"/>	<input type="checkbox"/>	18	The Board- (a) may, if it thinks fit, receive from any member willing to advance the same, all or any part of the monies uncalled and unpaid upon any shares held by him; and (b) upon all or any of the monies so advanced, may (until the same would, but for such advance, become presently payable) pay interest at such rate not exceeding, unless the company in general meeting shall otherwise direct, twelve per cent per annum, as may be agreed upon between the Board and the member paying the sum in advance.
			<b>Transfer of shares</b>
<input type="checkbox"/>	<input type="checkbox"/>	19	(i) The instrument of transfer of any share in the company shall be executed by or on behalf of both the transferor and transferee. (ii) The transferor shall be deemed to remain a holder of the share until the name of the transferee is entered in the register of members in respect thereof.
<input type="checkbox"/>	<input type="checkbox"/>	20	The Board may, subject to the right of appeal conferred by section 58 decline to register- (a) the transfer of a share, not being a fully paid share, to a person of whom they do not approve; or (b) any transfer of shares on which the company has a lien.
<input type="checkbox"/>	<input type="checkbox"/>	21	The Board may decline to recognise any instrument of transfer unless- (a) the instrument of transfer is in the form as prescribed in rules made under sub-section (1) of section 56; (b) the instrument of transfer is accompanied by the certificate of the shares to which it relates, and such other evidence as the Board may reasonably require to show the right of the transferor to make the transfer; and (c) the instrument of transfer is in respect of only one class of shares.
<input type="checkbox"/>	<input type="checkbox"/>	22	On giving not less than seven days' previous notice in accordance with section 91 and rules made thereunder, the registration of transfers may be suspended at such times and for such periods as the Board may from time to time determine: Provided that such registration shall not be suspended for more than thirty days at any one time or for more than forty-five days in the aggregate in any year.
			<b>Transmission of shares</b>
<input type="checkbox"/>	<input type="checkbox"/>	23	(i) On the death of a member, the survivor or survivors where the member was a joint holder, and his nominee or nominees or legal representatives where he was a sole holder, shall be the only persons recognised by the company as having any title to his interest in the shares (ii) Nothing in clause (i) shall release the estate of a deceased joint holder from any liability in respect of any share which had been jointly held by him with other persons.
<input type="checkbox"/>	<input type="checkbox"/>	24	(i) Any person becoming entitled to a share in consequence of the death or insolvency of a member may, upon such evidence being produced as may from time to time properly be required by the Board and subject as hereinafter provided, elect, either- (a) to be registered himself as holder of the share; or (b) to make such transfer of the share as the deceased or insolvent member could have made. (ii) The Board shall, in either case, have the same right to decline or suspend registration as it would have had, if the deceased or insolvent member had transferred the share before his death or insolvency.
<input type="checkbox"/>	<input type="checkbox"/>	25	(i) If the person so becoming entitled shall elect to be registered as holder of the share himself, he shall deliver or send to the company a notice in writing signed by him stating that he so elects. (ii) If the person aforesaid shall elect to transfer the share, he shall testify his election by executing a transfer of the share. (iii) All the limitations, restrictions and provisions of these regulations relating to the right to transfer and the registration of transfers of shares shall be applicable to any such notice or transfer as aforesaid as if the death



			and advantages as regards dividends, voting at meetings of the company, and other matters, as if they held the shares from which the stock arose; but no such privilege or advantage (except participation in the dividends and profits of the company and in the assets on winding up) shall be conferred by an amount of stock which would not, if existing in shares, have conferred that privilege or advantage. (c) such of the regulations of the company as are applicable to paid-up shares shall apply to stock and the words "share" and "shareholder" in those regulations shall include "stock" and "stock-holder" respectively.
<input type="checkbox"/>	<input type="checkbox"/>	37	The company may, by special resolution, reduce in any manner and with, and subject to, any incident authorised and consent required by law,- (a) its share capital; (b) any capital redemption reserve account; or (c) any share premium account.
			<b>Capitalisation of profits</b>
<input type="checkbox"/>	<input type="checkbox"/>	38	(i) The company in general meeting may, upon the recommendation of the Board, resolve- (a) that it is desirable to capitalise any part of the amount for the time being standing to the credit of any of the company's reserve accounts, or to the credit of the, profit and loss account, or otherwise available for distribution; and (b) that such sum be accordingly set free for distribution in the manner specified in clause (ii) amongst the members who would have been entitled thereto, if distributed by way of dividend and in the same proportions. (ii) The sum aforesaid shall not be paid in cash but shall be applied, subject to the provision contained in clause (iii), either in or towards- (A) paying up any amounts for the time being unpaid on any shares held by such members respectively; (B) paying up in full, unissued shares of the company to be allotted and distributed, credited as fully paid-up, to and amongst such members in the proportions aforesaid; (C) partly in the way specified in sub-clause (A) and partly in that specified in sub-clause (B); (D) A securities premium account and a capital redemption reserve account may, for the purposes of this regulation, be applied in the paying up of unissued shares to be issued to members of the company as fully paid bonus shares; (E) The Board shall give effect to the resolution passed by the company in pursuance of this regulation.
<input type="checkbox"/>	<input type="checkbox"/>	39	(i) Whenever such a resolution as aforesaid shall have been passed, the Board shall- (a) make all appropriations and applications of the undivided profits resolved to be capitalised thereby, and all allotments and issues of fully paid shares if any; and (b) generally do all acts and things required to give effect thereto. (ii) The Board shall have power- (a) to make such provisions, by the issue of fractional certificates or by payment in cash or otherwise as it thinks fit, for the case of shares becoming distributable in fractions; and (b) to authorise any person to enter, on behalf of all the members entitled thereto, into an agreement with the company providing for the allotment to them respectively, credited as fully paid-up, of any further shares to which they may be entitled upon such capitalisation, or as the case may require, for the payment by the company on their behalf, by the application thereto of their respective proportions of profits resolved to be capitalised, of the amount or any part of the amounts remaining unpaid on their existing shares; (iii) Any agreement made under such authority shall be effective and binding on such members.
			<b>Buy-back of shares</b>
<input checked="" type="checkbox"/>	<input type="checkbox"/>	40	Notwithstanding anything contained in these articles but subject to the provisions of sections 68 to 70 and any other applicable provision of the Act or any other law for the time being in force, the company may purchase its own shares or other specified securities.
			<b>General meetings</b>
<input type="checkbox"/>	<input type="checkbox"/>	41	All general meetings other than annual general meeting shall be called extraordinary general meeting.
<input type="checkbox"/>	<input type="checkbox"/>	42	(i) The Board may, whenever it thinks fit, call an extraordinary general meeting. (ii) If at any time directors capable of acting who are sufficient in number to form a quorum are not within India, any director or any two members of the company may call an extraordinary general meeting in the same manner, as nearly as possible, as that in which such a meeting may be called by the Board.
			<b>Proceedings at general meetings</b>
<input type="checkbox"/>	<input type="checkbox"/>	43	(i) No business shall be transacted at any general meeting unless a quorum of members is present at the time when the meeting proceeds to business. (ii) Save as otherwise provided herein, the quorum for the general meetings shall be as provided in section 103.
<input type="checkbox"/>	<input type="checkbox"/>	44	The chairperson, if any, of the Board shall preside as Chairperson at every general meeting of the company.

  
**PRINCIPAL**  
**Geethanjali College of Engg. and Tech.**  
**Cheerayal (V), Keesara (M), Medchal Dist. (T.S.)-501 301.**



<input type="checkbox"/>	<input type="checkbox"/>	59	(i) The remuneration of the directors shall, in so far as it consists of a monthly payment, be deemed to accrue from day-to-day. (ii) In addition to the remuneration payable to them in pursuance of the Act, the directors may be paid all travelling, hotel and other expenses properly incurred by them- (a) in attending and returning from meetings of the Board of Directors or any committee thereof or general meetings of the company; or (b) in connection with the business of the company.
<input type="checkbox"/>	<input type="checkbox"/>	60	The Board may pay all expenses incurred in getting up and registering the company.
<input type="checkbox"/>	<input type="checkbox"/>	61	The company may exercise the powers conferred on it by section 88 with regard to the keeping of a foreign register; and the Board may (subject to the provisions of that section) make and vary such regulations as it may think fit respecting the keeping of any such register.
<input type="checkbox"/>	<input type="checkbox"/>	62	All cheques, promissory notes, drafts, hundis, bills of exchange and other negotiable instruments, and all receipts for monies paid to the company, shall be signed, drawn, accepted, endorsed, or otherwise executed, as the case may be, by such person and in such manner as the Board shall from time to time by resolution determine.
<input type="checkbox"/>	<input type="checkbox"/>	63	Every director present at any meeting of the Board or of a committee thereof shall sign his name in a book to be kept for that purpose.
<input type="checkbox"/>	<input type="checkbox"/>	64	(i) Subject to the provisions of section 149, the Board shall have power at any time, and from time to time, to appoint a person as an additional director, provided the number of the directors and additional directors together shall not at any time exceed the maximum strength fixed for the Board by the articles. (ii) Such person shall hold office only up to the date of the next annual general meeting of the company but shall be eligible for appointment by the company as a director at that meeting subject to the provisions of the Act.
			<b>Proceedings of the Board</b>
<input type="checkbox"/>	<input type="checkbox"/>	65	(i) The Board of Directors may meet for the conduct of business, adjourn and otherwise regulate its meetings, as it thinks fit. (ii) A director may, and the manager or secretary on the requisition of a director shall, at any time, summon a meeting of the Board.
<input type="checkbox"/>	<input type="checkbox"/>	66	(i) Save as otherwise expressly provided in the Act, questions arising at any meeting of the Board shall be decided by a majority of votes. (ii) In case of an equality of votes, the Chairperson of the Board, if any, shall have a second or casting vote.
<input type="checkbox"/>	<input type="checkbox"/>	67	The continuing directors may act notwithstanding any vacancy in the Board; but, if and so long as their number is reduced below the quorum fixed by the Act for a meeting of the Board, the continuing directors or director may act for the purpose of increasing the number of directors to that fixed for the quorum, or of summoning a general meeting of the company, but for no other purpose.
<input type="checkbox"/>	<input type="checkbox"/>	68	(i) The Board may elect a Chairperson of its meetings and determine the period for which he is to hold office. (ii) If no such Chairperson is elected, or if at any meeting the Chairperson is not present within five minutes after the time appointed for holding the meeting, the directors present may choose one of their number to be Chairperson of the meeting.
<input type="checkbox"/>	<input type="checkbox"/>	69	(i) The Board may, subject to the provisions of the Act, delegate any of its powers to committees consisting of such member or members of its body as it thinks fit. (ii) Any committee so formed shall, in the exercise of the powers so delegated, conform to any regulations that may be imposed on it by the Board.
<input type="checkbox"/>	<input type="checkbox"/>	70	(i) A committee may elect a Chairperson of its meetings. (ii) If no such Chairperson is elected, or if at any meeting the Chairperson is not present within five minutes after the time appointed for holding the meeting, the members present may choose one of their members to be Chairperson of the meeting.
<input type="checkbox"/>	<input type="checkbox"/>	71	(i) A committee may meet and adjourn as it thinks fit. (ii) Questions arising at any meeting of a committee shall be determined by a majority of votes of the members present, and in case of an equality of votes, the Chairperson shall have a second or casting vote.
<input type="checkbox"/>	<input type="checkbox"/>	72	All acts done in any meeting of the Board or of a committee thereof or by any person acting as a director, shall, notwithstanding that it may be afterwards discovered that there was some defect in the appointment of any one or more of such directors or of any person acting as aforesaid, or that they or any of them were disqualified, be as valid as if every such director or such person had been duly appointed and was qualified to be a director.
<input type="checkbox"/>	<input type="checkbox"/>	73	Save as otherwise expressly provided in the Act, a resolution in writing, signed by all the members of the Board or of a committee thereof, for the time being entitled to receive notice of a meeting of the Board or committee, shall be valid and effective as if it had been passed at a meeting of the Board or committee, duly convened and held.
			<b>Chief Executive Officer, Manager, Company Secretary or Chief Financial Officer</b>

**Geethanjali College of Engg. and Tech.**  
Cheeryal (V), Keesara (M), Medchal Dist.(T.S.)-501 301.



			(ii) No member (not being a director) shall have any right of inspecting any account or book or document of the company except as conferred by law or authorised by the Board or by the company in general meeting.
			<b>Winding up</b>
<input type="checkbox"/>	<input type="checkbox"/>	87	<p>Subject to the provisions of Chapter XX of the Act and rules made thereunder-</p> <p>(i) If the company shall be wound up, the liquidator may, with the sanction of a special resolution of the company and any other sanction required by the Act, divide amongst the members, in specie or kind, the whole or any part of the assets of the company, whether they shall consist of property of the same kind or not.</p> <p>(ii) For the purpose aforesaid, the liquidator may set such value as he deems fair upon any property to be divided as aforesaid and may determine how such division shall be carried out as between the members or different classes of members.</p> <p>(iii) The liquidator may, with the like sanction, vest the whole or any part of such assets in trustees upon such trusts for the benefit of the contributories if he considers necessary, but so that no member shall be compelled to accept any shares or other securities whereon there is any liability.</p>
			<b>Indemnity</b>
<input type="checkbox"/>	<input type="checkbox"/>	88	Every officer of the company shall be indemnified out of the assets of the company against any liability incurred by him in defending any proceedings, whether civil or criminal, in which judgment is given in his favour or in which he is acquitted or in which relief is granted to him by the court or the Tribunal.

  
**PRINCIPAL**  
**Geethanjali College of Engg. and Tech.**  
**Cheeryal (V), Keesara (M), Medchal Dist.(T.S.)-501 301.**



\*Table  F as notified under schedule I of the companies Act, 2013 is applicable to the company

ZWEIRAD ELECTRIC PRIVATE LIMITED

A COMPANY LIMITED BY SHARES

Check if not applicable	Check if altered	Article No	Description
			<b>Interpretation</b>
<input checked="" type="checkbox"/>	<input checked="" type="checkbox"/>	I	<p>(1) In these regulations-</p> <p>(a) "the Act" means the Companies Act, 2013,</p> <p>(b) "the seal" means the common seal of the company.</p> <p>(2) Unless the context otherwise requires, words or expressions contained in these regulations shall bear the same meaning as in the Act or any statutory modification thereof in force at the date at which these regulations become binding on the company.</p> <p><b>PRIVATE COMPANY</b> The Company is a Private Company within the meaning of Section 2(68) of the Companies Act, 2013, and accordingly:</p> <p>(i) The right to transfer shares in the Company is restricted in the manner and to the extent herein after appearing;</p> <p>(ii) The number of members of the Company (exclusive of persons who are in the employment of the Company, and persons who having been formerly in the employment of the Company, were members of the Company while in the employment and have continued to be members after the employment ceased) shall be limited to two hundred; provided that for the purpose of this definition where two or more persons jointly hold one or more shares in the Company, the shall, be treated as a single member, and.</p> <p>(iii) prohibits any invitation to the public to subscribe for any securities of the company</p>
			<b>Share capital and variation of rights</b>
<input type="checkbox"/>	<input type="checkbox"/>	II 1	Subject to the provisions of the Act and these Articles, the shares in the capital of the company shall be under the control of the Directors who may issue, allot or otherwise dispose of the same or any of them to such persons, in such proportion and on such terms and conditions and either at a premium or at par and at such time as they may from time to time think fit.
<input type="checkbox"/>	<input type="checkbox"/>	2	<p>(i) Every person whose name is entered as a member in the register of members shall be entitled to receive within two months after incorporation, in case of subscribers to the memorandum or after allotment or within one month after the application for the registration of transfer or transmission or within such other period as the conditions of issue shall be provided,-</p> <p>(a) one certificate for all his shares without payment of any charges; or</p> <p>(b) several certificates, each for one or more of his shares, upon payment of twenty rupees for each certificate after the first.</p> <p>(ii) Every certificate shall be under the seal and shall specify the shares to which it relates and the amount paid-up thereon.</p> <p>(iii) In respect of any share or shares held jointly by several persons, the company shall not be bound to issue more than one certificate, and delivery of a certificate for a share to one of several joint holders shall be sufficient delivery to all such holders</p>



<input type="checkbox"/>	<input type="checkbox"/>	73	Save as otherwise expressly provided in the Act, a resolution in writing, signed by all the members of the Board or of a committee thereof, for the time being entitled to receive notice of a meeting of the Board or committee, shall be valid and effective as if it had been passed at a meeting of the Board or committee, duly convened and held.
			<b>Chief Executive Officer, Manager, Company Secretary or Chief Financial Officer</b>
<input type="checkbox"/>	<input type="checkbox"/>	74	Subject to the provisions of the Act,- (i) A chief executive officer, manager, company secretary or chief financial officer may be appointed by the Board for such term, at such remuneration and upon such conditions as it may think fit; and any chief executive officer, manager, company secretary or chief financial officer so appointed may be removed by means of a resolution of the Board; (ii) A director may be appointed as chief executive officer, manager, company secretary or chief financial officer
<input type="checkbox"/>	<input type="checkbox"/>	75	A provision of the Act or these regulations requiring or authorising a thing to be done by or to a director and chief executive officer, manager, company secretary or chief financial officer shall not be satisfied by its being done by or to the same person acting both as director and as, or in place of, chief executive officer, manager, company secretary or chief financial officer.
			<b>The Seal</b>
<input type="checkbox"/>	<input type="checkbox"/>	76	i) The Board shall provide for the safe custody of the seal. (ii) The seal of the company shall not be affixed to any instrument except by the authority of a resolution of the Board or of a committee of the Board authorised by it in that behalf, and except in the presence of at least two directors and of the secretary or such other person as the Board may appoint for the purpose; and those two directors and the secretary or other person aforesaid shall sign every instrument to which the seal of the company is so affixed in their presence.
			<b>Dividends and Reserve</b>
<input type="checkbox"/>	<input type="checkbox"/>	77	The company in general meeting may declare dividends, but no dividend shall exceed the amount recommended by the Board.
<input type="checkbox"/>	<input type="checkbox"/>	78	Subject to the provisions of section 123, the Board may from time to time pay to the members such interim dividends as appear to it to be justified by the profits of the company.
<input type="checkbox"/>	<input type="checkbox"/>	79	(i) The Board may, before recommending any dividend, set aside out of the profits of the company such sums as it thinks fit as a reserve or reserves which shall, at the discretion of the Board, be applicable for any purpose to which the profits of the company may be properly applied, including provision for meeting contingencies or for equalizing dividends; and pending such application, may, at the like discretion, either be employed in the business of the company or be invested in such investments (other than shares of the company) as the Board may, from time to time, think fit. (ii) The Board may also carry forward any profits which it may consider necessary not to divide, without setting them aside as a reserve.
<input type="checkbox"/>	<input type="checkbox"/>	80	(i) Subject to the rights of persons, if any, entitled to shares with special rights as to dividends, all dividends shall be declared and paid according to the amounts paid or credited as paid on the shares in respect whereof the dividend is paid, but if and so long as nothing is paid upon any of the shares in the company, dividends may be declared and paid according to the amounts of the shares. (ii) No amount paid or credited as paid on a share in advance of calls shall be treated for the purposes of this regulation as paid on the share. (iii) All dividends shall be apportioned and paid proportionately to the amounts paid or credited as paid on the shares during any portion or portions of the period in respect of which the dividend is paid; but if any share is issued on terms providing that it shall rank for dividend as from a particular date such share shall rank for dividend accordingly.
<input type="checkbox"/>	<input type="checkbox"/>	81	The Board may deduct from any dividend payable to any member all sums of money, if any, presently payable by him to the company on account of calls or otherwise in relation to the shares of the company.
<input type="checkbox"/>	<input type="checkbox"/>	82	(i) Any dividend, interest or other monies payable in cash in respect of shares may be paid by cheque or warrant sent through the post directed to the registered address of the holder or, in the case of joint holders, to the registered address of that one of the joint holders who is first named on the register of members, or to such person and to such address as the holder or joint holders may in writing direct. (ii) Every such cheque or warrant shall be made payable to the order of the person to whom it is sent.
<input type="checkbox"/>	<input type="checkbox"/>	83	Any one of two or more joint holders of a share may give effective receipts for any dividends, bonuses or other monies payable in respect of such share.
<input type="checkbox"/>	<input type="checkbox"/>	84	Notice of any dividend that may have been declared shall be given to the persons entitled to share therein in the manner mentioned in the Act.



<input type="checkbox"/>	<input type="checkbox"/>	85	No dividend shall bear interest against the company.
			<b>Accounts</b>
<input type="checkbox"/>	<input type="checkbox"/>	86	(i) The Board shall from time to time determine whether and to what extent and at what times and places and under what conditions or regulations, the accounts and books of the company, or any of them, shall be open to the inspection of members not being directors. (ii) No member (not being a director) shall have any right of inspecting any account or book or document of the company except as conferred by law or authorised by the Board or by the company in general meeting.
			<b>Winding up</b>
<input type="checkbox"/>	<input type="checkbox"/>	87	Subject to the provisions of Chapter XX of the Act and rules made thereunder- (i) If the company shall be wound up, the liquidator may, with the sanction of a special resolution of the company and any other sanction required by the Act, divide amongst the members, in specie or kind, the whole or any part of the assets of the company, whether they shall consist of property of the same kind or not. (ii) For the purpose aforesaid, the liquidator may set such value as he deems fair upon any property to be divided as aforesaid and may determine how such division shall be carried out as between the members or different classes of members. (iii) The liquidator may, with the like sanction, vest the whole or any part of such assets in trustees upon such trusts for the benefit of the contributories if he considers necessary, but so that no member shall be compelled to accept any shares or other securities whereon there is any liability.
			<b>Indemnity</b>
<input type="checkbox"/>	<input type="checkbox"/>	88	Every officer of the company shall be indemnified out of the assets of the company against any liability incurred by him in defending any proceedings, whether civil or criminal, in which judgment is given in his favour or in which he is acquitted or in which relief is granted to him by the court or the Tribunal.

  
**PRINCIPAL**  
 Geethanjali College of Engg. and Tech.  
 Cheeryal (V), Keesara (M), Medchal Dist.(T.S.)-501 301.



<b>Board of Directors</b>				
58	The number of the directors and the names of the first directors shall be determined in writing by the subscribers of the memorandum or a majority of them. AADHARI SANTHOSH PAN-AWZPA6670P SANDI RAHUL REDDY PAN-IBZPS3343N JEERU MANEESH KUMAR REDDY PAN-BSIPR0317J	<input checked="" type="checkbox"/>	<input type="checkbox"/>	
59	(i) The remuneration of the directors shall, in so far as it consists of a monthly payment, be deemed to accrue from day-to-day. (ii) In addition to the remuneration payable to them in pursuance of the Act, the directors may be paid all travelling, hotel and other expenses properly incurred by them- (a) in attending and returning from meetings of the Board of Directors or any committee thereof or general meetings of the company; or (b) in connection with the business of the company. The Board may pay the expenses incurred in getting the company registered in the company.	<input type="checkbox"/>	<input type="checkbox"/>	
60	The company may exercise the powers conferred on it by section 88 with regard to the keeping of a foreign register; and the Board may (subject to the provisions of that section) make and vary such regulations as it may think fit respecting the keeping of any such register. All cheques, promissory notes, drafts, hundis, bills of exchange and other negotiable instruments, and all receipts for monies paid to the company, shall be signed, drawn, accepted, endorsed, or otherwise executed, as the case may be, by such person and in such manner as the Board shall from time to time by resolution determine. Every director present at any meeting of the Board or of a committee thereof shall sign his name in a book to be kept for that purpose.	<input type="checkbox"/>	<input type="checkbox"/>	
61	(i) Subject to the provisions of section 149, the Board shall have power at any time, and from time to time, to appoint a person as an additional director, provided the number of the directors and additional directors together shall not at any time exceed the maximum strength fixed for the Board by the articles. (ii) Such person shall hold office only up to the date of the next annual general meeting of the company but shall be eligible for appointment by the company as a director at that meeting subject to the provisions of the Act.	<input type="checkbox"/>	<input type="checkbox"/>	
62	(i) The Board of Directors may meet for the conduct of business, adjourn and otherwise regulate its meetings, as it thinks fit. (ii) A director may, and the manager or secretary on the requisition of a director shall, at any time, summon a meeting of the Board. (i) Save as otherwise expressly provided in the Act, questions arising at any meeting of the Board shall be decided by a majority of votes. (ii) In case of an equality of votes, the Chairperson of the Board, if any, shall have a second or casting vote.	<input type="checkbox"/>	<input type="checkbox"/>	
63	The continuing directors may act notwithstanding any vacancy in the Board; but, if and so long as their number is reduced below the quorum fixed by the Act for a meeting of the Board, the continuing directors or director may act for the purpose of increasing the number of directors to that fixed for the quorum, or of summoning a general meeting of the company, but for no other purpose. (i) The Board may elect a Chairperson of its meetings and determine the period for which he is to hold office. (ii) If no such Chairperson is elected, or if at any meeting the Chairperson is not present within five minutes after the time appointed for holding the meeting, the directors present may choose one of their number to be Chairperson of the meeting. (i) The Board may, subject to the provisions of the Act, delegate any of its powers to committees consisting of such member or members of its body as it thinks fit. (ii) Any committee so formed shall, in the exercise of the powers so delegated, conform to any regulations that may be imposed on it by the Board.	<input type="checkbox"/>	<input type="checkbox"/>	
64	(i) A committee may elect a Chairperson of its meetings. (ii) If no such Chairperson is elected, or if at any meeting the Chairperson is not present within five minutes after the time appointed for holding the meeting, the members present may choose one of their members to be Chairperson of the meeting. (i) A committee may meet and adjourn as it thinks fit. (ii) Questions arising at any meeting of a committee shall be determined by a majority of votes of the members present, and in case of an equality of votes, the Chairperson shall have a second or casting vote.	<input type="checkbox"/>	<input type="checkbox"/>	
65	All acts done in any meeting of the Board or of a committee thereof or by any person acting as a director, shall, notwithstanding that it may be afterwards discovered that there was some defect in the appointment of any one or more of such directors or of any person acting as aforesaid, or that they or any of them were disqualified, be as valid as if every such director or such person had been duly appointed and was qualified to be a director.	<input type="checkbox"/>	<input type="checkbox"/>	
66		<input type="checkbox"/>	<input type="checkbox"/>	
67		<input type="checkbox"/>	<input type="checkbox"/>	
68		<input type="checkbox"/>	<input type="checkbox"/>	
69		<input type="checkbox"/>	<input type="checkbox"/>	
70		<input type="checkbox"/>	<input type="checkbox"/>	
71		<input type="checkbox"/>	<input type="checkbox"/>	
72		<input type="checkbox"/>	<input type="checkbox"/>	

**PRINCIPAL**  
Geethanjali Gopinath & Associates  
Chartered Accountants  
106/107-3/3, Kanchana Nagar, Mysore  
(Karnataka)



<input type="checkbox"/>	<input type="checkbox"/>	36	<p>Where shares are converted into stock,-</p> <p>(a) the holders of stock may transfer the same or any part thereof in the same manner as, and subject to the same regulations under which, the shares from which the stock arose might before the conversion have been transferred, or as near thereto as circumstances admit.</p> <p>Provided that the Board may, from time to time, fix the minimum amount of stock transferable, so, however, that such minimum shall not exceed the nominal amount of the shares from which the stock arose.</p> <p>(b) the holders of stock shall, according to the amount of stock held by them, have the same rights, privileges and advantages as regards dividends, voting at meetings of the company, and other matters, as if they held the shares from which the stock arose; but no such privilege or advantage (except participation in the dividends and profits of the company and in the assets on winding up) shall be conferred by an amount of stock which would not, if existing in shares, have conferred that privilege or advantage.</p> <p>(c) such of the regulations of the company as are applicable to paid-up shares shall apply to stock and the words "share" and "shareholder" in those regulations shall include "stock" and "stock-holder" respectively.</p>
<input type="checkbox"/>	<input type="checkbox"/>	37	<p>The company may, by special resolution, reduce in any manner and with, and subject to, any incident authorised and consent required by law,-</p> <p>(a) its share capital;</p> <p>(b) any capital redemption reserve account; or</p> <p>(c) any share premium account.</p>
			<b>Capitalisation of profits</b>
<input type="checkbox"/>	<input type="checkbox"/>	38	<p>(i) The company in general meeting may, upon the recommendation of the Board, resolve-</p> <p>(a) that it is desirable to capitalise any part of the amount for the time being standing to the credit of any of the company's reserve accounts, or to the credit of the, profit and loss account, or otherwise available for distribution; and</p> <p>(b) that such sum be accordingly set free for distribution in the manner specified in clause (ii) amongst the members who would have been entitled thereto, if distributed by way of dividend and in the same proportions.</p> <p>(ii) The sum aforesaid shall not be paid in cash but shall be applied, subject to the provision contained in clause (iii), either in or towards-</p> <p>(A) paying up any amounts for the time being unpaid on any shares held by such members respectively;</p> <p>(B) paying up in full, unissued shares of the company to be allotted and distributed, credited as fully paid-up, to and amongst such members in the proportions aforesaid;</p> <p>(C) partly in the way specified in sub-clause (A) and partly in that specified in sub-clause (B);</p> <p>(D) A securities premium account and a capital redemption reserve account may, for the purposes of this regulation, be applied in the paying up of unissued shares to be issued to members of the company as fully paid bonus shares;</p> <p>(E) The Board shall give effect to the resolution passed by the company in pursuance of this regulation.</p>
<input type="checkbox"/>	<input type="checkbox"/>	39	<p>(i) Whenever such a resolution as aforesaid shall have been passed, the Board shall-</p> <p>(a) make all appropriations and applications of the undivided profits resolved to be capitalised thereby, and all allotments and issues of fully paid shares if any; and</p> <p>(b) generally do all acts and things required to give effect thereto.</p> <p>(ii) The Board shall have power-</p> <p>(a) to make such provisions, by the issue of fractional certificates or by payment in cash or otherwise as it thinks fit, for the case of shares becoming distributable in fractions; and</p> <p>(b) to authorise any person to enter, on behalf of all the members entitled thereto, into an agreement with the company providing for the allotment to them respectively, credited as fully paid-up, of any further shares to which they may be entitled upon such capitalisation, or as the case may require, for the payment by the company on their behalf, by the application thereto of their respective proportions of profits resolved to be capitalised, of the amount or any part of the amounts remaining unpaid on their existing shares;</p> <p>(iii) Any agreement made under such authority shall be effective and binding on such members.</p>
			<b>Buy-back of shares</b>
<input type="checkbox"/>	<input type="checkbox"/>	40	Notwithstanding anything contained in these articles but subject to the provisions of sections 68 to 70 and any other applicable provision of the Act or any other law for the time being in force, the company may purchase its own shares or other specified securities.
			<b>General meetings</b>
<input type="checkbox"/>	<input type="checkbox"/>	41	All general meetings other than annual general meeting shall be called extraordinary general meeting.
<input type="checkbox"/>	<input type="checkbox"/>	42	<p>(i) The Board may, whenever it thinks fit, call an extraordinary general meeting.</p> <p>(ii) If at any time directors capable of acting who are sufficient in number to form a quorum are not within India, any director or any two members of the company may call an extraordinary general meeting in the same manner, as nearly as possible, as that in which such a meeting may be called by the Board.</p>
			<b>Proceedings at general meetings</b>

GEETHANJALI COLLEGE OF ENGINEERING AND T

C/O GCOEAT SY NO 33 AND 34 CHERIYAL

VILLAGE KEESARA MANDAL GEETHANJALI

COLLEGE OF ENGINEERING

HYDERABAD, TELANGANA. Pin : 501301

PAYMENT ADVICE

---

Transaction Date	:	27/11/2021
Remitter Name	:	GEETHANJALI COLLEGE OF ENGINEERING AND T
Remitter's Account No	:	50100457758976
Beneficiary Code	:	
Beneficiary Name	:	ROOPALI J
Beneficiary Account No	:	008010101928387
Transaction Remarks	:	IMPS - UTIB0002210 - C77730271121143059 - - 008010101928387 - ROOPALI J
Reference No	:	155170826
Payment mode	:	IMPS
UTR / RRN No	:	133114457876
Amount	:	3000.00
Amount in Words	:	Three Thousand Rupees

---

Dear Sir / Madam

We have initiated your payment for an amount of Rs. 3000.00 for the services rendered / to be rendered against the below mentioned details

Payment Details 1 :  
Payment Details 2 :  
Payment Details 3 :

  
**PRINCIPAL**  
Geethanjali College of Engg. and Tech.  
Cheeryal (V), Keesara (M), Medchal Dist.(T.S.)-501 301.

  
**PRINCIPAL**  
P.V.M: 2252  
Date: 27/11/21





Geethanjali

Phones : 9182058186

9182058196

9182058198

E-mail : info@gcet.edu.in

Website: www.geethanjaliinstitutions.com

# TEJA EDUCATIONAL SOCIETY

(Accredited by NBA, Approved by AICTE, New Delhi and Affiliated to JNTUH, Hyderabad)

Sy.No. 33 & 34, Cheeryal (V), Keesara (M), Medchal District. - 501 301.

No Objection Certificate

To Whomsoever It may Concern

I, G. Sridevi, President of Teja Educational Society, do hereby state the following:

Teja Educational Society owns Cabin 1, Sy No: 33 & 34 Cheeryal, Keesara (M) Ranga Reddy, District, 501301 and I being president of the society do hereby state that we have no objection for using the said premises for the registered office purpose of Zweirad Electric Private Limited with a rent to be mutually fixed by us and the said proposed company in due course

For

Teja Educational Society

President

For Teja Educational Society

*G. Sridevi*

G. Sridevi

President.



PRINCIPAL

Geethanjali College of Engg. and Tech.  
Cheeryal (V), Keesara (M), Medchal Dist.(T.S.)-501 301.



Geethanjali

Phones : 9182058186

9182058196

9182058198

E-mail : info@gcet.edu.in

Website: www.geethanjalinstitutions.com

# TEJA EDUCATIONAL SOCIETY

(Accredited by NBA, Approved by AICTE, New Delhi and Affiliated to JNTUH, Hyderabad)

Sy.No. 33 & 34, Cheeryal (V), Keesara (M), Medchal District. - 501 301.

## NO OBJECTION CERTIFICATE

TO WHOMSOEVER IT MAY CONCERN

I, G.Sridevi, President of Teja Educational Society, do hereby state the following:

Teja Educational Society owns CABIN 1, SY NO 33&34, CHERIYAL (V), KEESARA (M), RANGAREDDY DISTRICT -501301 and I being President of the said society do hereby state that we have no objection for using the said premises for the registered office purpose of VIDYUTH VAAHAN PRIVATE LIMITED with a rent to be mutually fixed by us and the said proposed company in due course.

For

TEJA EDUCATIONAL SOCIETY

For Teja Educational Society

*G. Sridevi*

President

President

G.SRIDEVI



*[Handwritten signature]*

PRINCIPAL

Geethanjali College of Engg. and Tech.  
Cheeryal (V), Keesara (M), Medchal Dist. (T.S.)-501 301.



SOUTHERN POWER DISTRIBUTION COMPANY OF TS LIMITED  
 HT C.C. Bill for the month of August 2021, Date: 26-Aug-21  
 PAYABLE ON OR BEFORE dated: 09-Sep-21 DISCONNECTION DATE: 24-Sep-21

Contracted MD (KVA/HP)	200	Consumer No.	HBG2780
Specified Voltage (KV)	11	Name	M/S. TEJA EDUCATIONAL SOCIETY.
Actual Voltage (KV)	11	ADDRESS1	SY.NO.31, CHERYAL (V),
Feeder : 114512140503 (CF)		ADDRESS2	KEESARA (M),
Category	2	ADDRESS3	R.R.DIST

	KWH	KVAH	KVA	TOD1	TOD2
Reading On 20-AUG-21	293092.00	300561.00	40.42	35754.00	60955.00
Reading On 19-JUL-21	286273.60	293635.70		35042.30	59351.40
Difference ST:01	6818.40	6925.30		711.70	1603.60
Multipling Factor	2.00	2.00	2.00	2.00	2.00
Total Consumption	13637.00	13851.00	80.84	1423.00	3207.00
Monthly Minimum Units	4000.00		160.00		
Main Consumption	10524.00	Colony	0.00	L&F	0.00

	RATE	KVA/UNITS	AMOUNT Rs.
Demand Charges Normal	Rs.390	160	62400.00
Demand Charges Penal	Rs.780	0	0.00
Energy Charges	Ps.780	10524	82087.20
TOD Charges	Ps.100	4630	4630.00
Electricity Duty	Ps.6	10524	631.44
Colony Charges	Ps.630	0	0.00
L&F Charges	Ps.780	0	0.00
FSA Charges			0.00

Supplier Name	NetKWH	KVA	TOD	Sub Total	
				149748.64	
				Cust Charges	1685.00
				ACD SCHG	0.00
				UI Charges	0
				CS Surcharge	0.00
				Addl.SCHG OA	0.00
				Late Pmt Chrg	0.00
				Interest on ED	0
				Incentive TOD1	-4296.00
				Incentive TOD2	-1535.00
				Wheeling Charges	0
				Transmission Charges	0
				Other Charges-I	0.00
				Other Charges-II	0.00
				Gross Total	145603.00
				C.C.Charge	0.00
				TCs on Arrear	0.00
				IT TCS U/s 206C(1H)	0.00
				Other Credit Adj.	0.00
				Net Bill Amount	145603.00
				Total Arrears	0.00
				Total Amount Payable	145603.00

Note: ACD Due for 2021-22 Rs. 0  
 One Lakh Fourty Five Thousand Six Hundred and Three Only  
 Note: This bill is settled based on the provisions of inter state settlements.  
 If any short fall occurred in this bill due to the inter state Open Access provisions, the same will be levied in your future bills.

Note: PAY YOUR BILL THROUGH THE SBI A/C NO. SPDCLPBG2780 OP.CIRCLE  
 IFSC CODE: SBIN0004266

Senior Accounts Officer  
 Geethanjali College of Engg. and Tech.  
 Cheryal (V), Keesara (M), Medchal Dist.(T.S.)-501 301.

SOUTHERN POWER DISTRIBUTION COMPANY OF TS LIMITED  
 HT C.C. Bill for the month of August 2021, Date: 26-Aug-21  
 PAYABLE ON OR BEFORE dated: 09-Sep-21 DISCONNECTION DATE: 24-Sep-21

Contracted MD (KVA/HP) 125		Consumer No. HBG1682		
Specified Voltage (KV) 11		Name		M/S. TEJA EDUCATIONAL SOCIETY
Actual Voltage (KV) 11		ADDRESS1		SY.NO.22&34,CHERIYAL (V),
Feeder : 114512140503 (CF)		ADDRESS2		KEESARA (M),
Category 2		ADDRESS3		R.R.DIST

	KWH	KVAH	KVA	TOD1	TOD2
Reading On 20-AUG-21	136244.00	149487.00	22.36	18485.00	31718.00
Reading On 19-JUL-21	133454.30	146582.00		18171.90	30993.50
Difference ST:01	2789.70	2905.00		313.10	724.50
Multipling Factor	2.00	2.00	2.00	2.00	2.00
Total Consumption	5579.00	5810.00	44.72	626.00	1449.00
Monthly Minimum Units	2500.00		100.00		
Main Consumption	2903.00	Colony	0.00	L&F	0.00

	RATE	KVA/UNITS	AMOUNT Rs.
Demand Charges Normal	Rs.390	100	39000.00
Demand Charges Penal	Rs.780	0	0.00
Energy Charges	Ps.780	2903	22643.40
TOD Charges	Ps.100	2075	2075.00
Electricity Duty	Ps.6	2903	174.18
Colony Charges	Ps.630	0	0.00
L&F Charges	Ps.780	0	0.00
FSA Charges			0.00

Supplier Name	NetKWH	KVA	TOD	Sub Total	63892.58
				Cust Charges	1685.00
				ACD SCHG	0.00
				UI Charges	0
				CS Surcharge	0.00
				Addl.SCHG OA	0.00
				Late Pmt Chrg	0.00
*****Net Meter(KWH) Details*****				INCENTIVE ED	0
Closing/Opening Reading :	8095	505.5		Incentive TOD1	-1814.00
Recorded Units :	2907			Incentive TOD2	-644.00
Opening Balance Units:	0			Wheeling Charges	0
Cumulative Banked Units :	0			Transmission Charges	0
*****				Other Charges-I	0.00
				Other Charges-II	0.00
*****Arrears as on 23/08/21*****				Gross Total	63120.00
	C.C.Charge	TC	OnArrear	IT TCS U/s 206C(1H)	0.00
Court Cases Rs.	0			Other Credit Adj.	0.00
Others Rs.	0	0.00		Net Bill Amount	63120.00
Total Rs.	0			Total Arrears	0.00
*****				Total Amount Payable	63120.00

Note: ACD Due for 2021-22 Rs. 0

Sixty Three Thousand One Hundred and Twenty Only

Note: This bill is settled based on the provisions of inter state settlements. If any short fall occurred in this bill due to the inter state Open Access provisions, the same will be levied in your future bills.

Senior Accounts Officer

Note: PAY YOUR BILL THROUGH THE SBI A/C NO.SPDCPLPHBG1682 OP.CIRCLE  
 IFSC CODE: SBIN0004266



SOUTHERN POWER DISTRIBUTION COMPANY OF TS LIMITED  
 HT C.C. Bill for the month of August 2021, Date: 26-Aug-21  
 PAYABLE ON OR BEFORE dated: 09-Sep-21 DISCONNECTION DATE: 24-Sep-21

Contracted MD (KVA/HP) 125		Consumer No. HBG1682
Specified Voltage (KV) 11		Name M/S. TEJA EDUCATIONAL SOCIETY
Actual Voltage (KV) 11		ADDRESS1 SY.NO.22&34,CHERIYAL(V),
Feeder : 114512140503 (CF)		ADDRESS2 KEESARA (M),
Category 2		ADDRESS3 R.R.DIST

	KWH	KVAH	KVA	TOD1	TOD2
Reading On 20-AUG-21	136244.00	149487.00	22.36	18485.00	31718.00
Reading On 19-JUL-21	133454.30	146582.00		18171.90	30993.50
Difference ST:01	2789.70	2905.00		313.10	724.50
Multiplying Factor	2.00	2.00	2.00	2.00	2.00
Total Consumption	5579.00	5810.00	44.72	626.00	1449.00
Monthly Minimum Units	2500.00		100.00		
Main Consumption	2903.00	Colony	0.00	L&F	0.00

	RATE	KVA/UNITS	AMOUNT Rs.
Demand Charges Normal	Rs.390	100	39000.00
Demand Charges Penal	Rs.780	0	0.00
Energy Charges	Ps.780	2903	22643.40
TOD Charges	Ps.100	2075	2075.00
Electricity Duty	Ps.6	2903	174.18
Colony Charges	Ps.630	0	0.00
L&F Charges	Ps.780	0	0.00
FSA Charges			0.00

Supplier Name	NetKWH	KVA	TOD	Sub Total	63892.58
				Cust Charges	1685.00
				ACD SCHG	0.00
				UI Charges	0
				CS Surcharge	0.00
				Addl.SCHG OA	0.00
				Late Pmt Chrg	0.00
*****Net Meter (KWH) Details*****				Interest on ED	0
Closing/Opening Reading : 80959.00 / 2505.00				Incentive on ED	0
Recorded Units : 2907				Incentive TOD1	-1814.00
Opening Balance Units:0				Incentive TOD2	-644.00
Cumulative Banked Units : 0				Wheeling Charges	0
*****				Transmission Charges	0
*****Arrears as on 23/08/21*****				Other Charges-I	0.00
				Other Charges-II	0.00
				Gross Total	63120.00
C.C.Charge TCsonArrear IT TCS U/s 206C(1H)					0.00
Court Cases Rs. 0				Other Credit Adj.	
Others Rs. 0				Net Bill Amount	63120.00
Total Rs. 0				Total Arrears	0.00
*****				Total Amount Payable	63120.00

Note: ACD Due for 2021-22 Rs. 0  
 Sixty Three Thousand One Hundred and Twenty Only  
 Note: This bill is settled based on the provisions of inter state settlements.  
 If any short fall occurred in this bill due to the inter state Open Access provisions, the same will be levied in your future bills.

Senior Accounts Officer

Note: PAY YOUR BILL THROUGH THE SBI A/C NO.SPDCLPHBG1682 OP.CIRCLE  
 IFSC CODE: SBIN0004266

SOUTHERN POWER DISTRIBUTION COMPANY OF TS LIMITED  
 HT C.C. Bill for the month of August 2021, Date: 26-Aug-21  
 PAYABLE ON OR BEFORE dated: 09-Sep-21 DISCONNECTION DATE: 24-Sep-21

Contracted MD (KVA/HP)	200	Consumer No.	HBG2780
Specified Voltage (KV)	11	Name	M/S. TEJA EDUCATIONAL SOCIETY.
Actual Voltage (KV)	11	ADDRESS1	SY.NO.31, CHERYAL (V),
Feeder : 114512140503 (CF)		ADDRESS2	KEESARA (M),
Category	2	ADDRESS3	R.R.DIST

	KWH	KVAH	KVA	TOD1	TOD2
Reading On 20-AUG-21	293092.00	300561.00	40.42	35754.00	60955.00
Reading On 19-JUL-21	286273.60	293635.70		35042.30	59351.40
Difference ST:01	6818.40	6925.30		711.70	1603.60
Multiplying Factor	2.00	2.00	2.00	2.00	2.00
Total Consumption	13637.00	13851.00	80.84	1423.00	3207.00
Monthly Minimum Units	4000.00		160.00		
Main Consumption	10524.00	Colony	0.00	L&F	0.00

	RATE	KVA/UNITS	AMOUNT Rs.
Demand Charges Normal	Rs.390	160	62400.00
Demand Charges Penal	Rs.780	0	0.00
Energy Charges	Ps.780	10524	82087.20
TOD Charges	Ps.100	4630	4630.00
Electricity Duty	Ps.6	10524	631.44
Colony Charges	Ps.630	0	0.00
L&F Charges	Ps.780	0	0.00
FSA Charges			0.00

Supplier Name	NetKWH	KVA	TOD	Sub Total	149748.64
				Cust Charges	1685.00
				ACD SCHG	0.00
				UI Charges	0
				CS Surcharge	0.00
				Adtl.SCHG OA	0.00
				Late Pmt Chrg	0.00
				Interest on ED	0
*****Net Meter(KWH) Details*****				Incentive TOD1	-4296.00
Closing/Opening Reading : 74230/72566.7				Incentive TOD2	-1535.00
Recorded Units : 3327				Wheeling Charges	0
Opening Balance Units:0				Transmission Charges	0
Cumulative Banked Units : 0				Other Charges-I	0.00
*****				Other Charges-II	0.00
*****Arrears as on 23/08/21*****				Gross Total	145603.00
C.C.Charge		TCsonArrear	IT TCS U/s 206C(1H)		0.00
Court Cases Rs.	0		Other Credit Adj.		
Others Rs.	0	0.00	Net Bill Amount		145603.00
Total Rs.	0		Total Arrears		0.00
*****			Total Amount Payable		145603.00

Note: ACD Due for 2021-22 Rs. 0  
 One Lakh Fourty Five Thousand Six Hundred and Three Only  
 Note: This bill is settled based on the provisions of inter state settlements.  
 If any short fall occurred in this bill due to the inter state Open Access provisions, the same will be levied in your future bills.

Senior Accounts Officer

Note: PAY YOUR BILL THROUGH THE SBI A/C NO.SPDCLPHBG2780 OP.CIRCLE  
 IFSC CODE: SBIN0004266



**APPLICANT DECLARATION**

1. I/We affirm and declare that I/We have read over and understood the rules and regulations of the State Bank of India ("Bank") and those relating to various services offered by the Bank including but not limiting to debit card/internet banking/SMS banking/Tele-banking/Mobile Banking/Virtual Banking and any other facilities. I/We agree to abide by the same as amended/modified from time to time by the Bank/Regulator/Government published through circulars, notifications, notice board/websites/newspaper publications, etc. I/We waive the rights, if any, to have personal notice in respect of such amendments/ modifications. I/We agree that the transactions and requests executed in my/our account(s) by me/authorized person through internet, mobile, tele- banking or virtual banking under my/our User ID and password/PIN/OTP will be legally binding on me/us & I/We am/are responsible for the maintenance of secrecy and confidentiality of the authentication credentials and any other information/details/OTP/PIN, etc., in such matters. I/We agree that Bank has got all the rights to debit my/our account for any service charge, expenses or other dues which the Bank is entitled/ liable to recover from me. I/We also authorise the Bank and agree to close/discontinue my account without any notice to me in case of any violation of laws/rules/regulations or terms and conditions of maintaining the account. I/We hereby undertake to inform the Bank on any change in my communication address or constitution, and I/We shall submit the address proof in case of transfer of my account from one branch to another branch.
2. In respect of accounts opened on the basis of Aadhaar details, I hereby declare that I have submitted the Aadhaar Card issued by UIDAI for identification and / or address proof towards the compliance of KYC norms under the PMLA , 2002 and I hereby agree that the Bank may verify the same with UIDAI and authorise the UIDAI expressly to release the identity and address through biometric authentication to the Bank.
3. I/We confirm and declare that I/We am/are not prevented/prohibited/restricted by any applicable legal/regulatory/contractual or other provisions from opening and/or maintaining the accounts or to transact with the Bank in any other way.
4. I/We agree that my/our personal KYC details may be shared with Central KYC registry or any other competent authority. I/We hereby consent to receive information from the Bank/Central KYC Registry/GoI/RBI or any other authority through SMS/e-mail on my registered mobile number/ e-mail address. I/We also agree that the non-receipt of any such SMS/e-mail shall not make the Bank liable for any loss or damage whatsoever in nature.
5. I/We hereby certify that I/We have declared my status as per the rules applicable under section 285BA of the Income Tax Act, 1961 as notified by Central Board of Direct Taxes (CBDT) vide Notification No. S.O. 2155(E) dated 7 August 2015 and RBI Circular Ref No. DBR.AML.BC.No.36/ 14.01.001/2015-16 dated 28 August 2015 in the matter including any subsequent modification/amendment thereof.
6. I/We understand, acknowledge and authorize that as per the provisions of Income Tax Act, Rules made thereunder and the guidelines issued by the Government/RBI in the matter, depending upon the residential status and/or other criteria stipulated therein, the Bank may have to report the details in respect of my/our account(s) as per the prescribed format to the Central Board of Direct Taxes (CBDT) or other Government Agencies to comply with the obligations as per the Inter- Governmental Agreements (IGA) in respect of Foreign Accounts Tax Compliance Act (FATCA) and Common Reporting Standards (CRS) and / or any other similar arrangements.
7. I/We certify & declare that the information provided by me/us for opening account and availing other services herein or through website/electronically as applicable to me/us and signed/authenticated by me/us as well as in the documentary evidence provided by me/us for opening account and availing other services are, to the best of my/our knowledge and belief, true, correct and complete and that I/We have not withheld any material information that may affect the assessment/categorization of my/our account as Reportable Account or Other Reportable Account or otherwise. In case any of the information or details provided by me/us is found to be false or untrue or misleading or misrepresenting, I/We am/are aware that I/We may be held liable for it.
8. I/We undertake the responsibility to declare and disclose immediately and in no case beyond 30 days from the date of change, any changes that may take place in the information provided herein/or otherwise, as well as in the documentary evidence provided by me or if any certification becomes incorrect or undergoes a change. I further undertake to provide fresh and valid self-certification along with documentary evidence as and when so required; nevertheless all declaration and undertaking given herein will also be applicable to all such modified/amended documents/information provided by me unless revised self-certification as above is provided to the Bank.
9. I/We also agree that my failure to disclose any material fact/information known to me/us now or in future or my failure to remedy any deficiency in documents/information/other details within the stipulated period, may invalidate me from transacting in the account and the Bank would be within its right to put restrictions in the operations of my account or to close it or to report to any regulator and/or any authority designated by the Government of India (GoI)/RBI for the said purpose or take any other action as may be deemed appropriate by the Bank under the guidelines issued by CBDT/RBI/GoI from time to time.
10. I/We also agree to furnish and intimate to the Bank any other particulars that are called upon me/us to provide on account of any change in law either in India or abroad in relating to the operation or maintenance of the account.
11. I/We shall indemnify the Bank from any loss/damage that may be caused to the Bank on account of any defect/mistake in the details provided herein or on account of providing incorrect or incomplete information by me/us.
12. I/We undertake to submit data/information together with fresh KYC documents for updation of KYC details at periodical intervals as may be required by the Bank.
13. I/We understand that the account will be activated and debits will be allowed only after completion of Customer Due Diligence relating to KYC by the Bank.
14. I/We have been advised of Monthly average/minimum balance requirement for the account to be opened and given to understand that these requirements are subject to revision/change and such revision/changes will be uploaded in the Bank's site which will be acceptable to me as a notice to that effect.
15. I/We also agree that our failure to disclose any material facts known to us , now or in future , may invalidate us from transacting in the Account and State Bank of India would be within its right to put restrictions in the operations of our account or close it or report to any regulator and / or any other appropriate authority or to take any other action as may be deemed appropriate by State Bank of India, if the deficiency is not remedied by us within the stipulated period.
16. In Case any of the information herein is found to be false/untrue/misleading/misrepresenting, I/we are aware that I/we may be held liable for the same.
17. I/We Undertake to submit Aadhaar and / or PAN within 6 months from the date of opening of account , failing to which I understand my account will cease to be operational as per GOI guidelines, amending Prevention of Money laundering (Maintenance of Records ) Rules 2005.(In case the account is opened without Aadhaar / PAN ) In case, deemed OVDs are submitted for current address at the time of Account opening, I undertake to submit Aadhaar or any of the OVD having Current Address within 3 months from the date of account opening , failing to which I understand that my account may cease to be operational as per GOI guidelines at the material time.

Please paste  
photograph  
here

Please paste  
photograph  
here

Please paste  
photograph  
here

Signature of Authorized Signatory
Name
Designation
Date
Name, Signature, Seal and S.S No. of

Geethanjali College of Engg. and Tech.  
Cheeryal (V), Keesara (M), Medchal Dist.(T.S.)-501 301.

Signature of Authorized Signatory
Name
Designation
Date
Name, Signature, Seal and S.S No. of

Signature of Authorized Signatory
Name
Designation
Date
Name, Signature, Seal and S.S No. of





## Letter of Membership Allotment (LMA)

### IMPORTANT NOTES

- This Membership Allotment Letter is NOT VALID –
  - a. unless accompanied by General Terms & Conditions as agreed mutually
  - b. Beyond the validity date as per clause a (iii) below
  - c. Unless digitally signed by the authorized signatory of T-Hub Foundation
- T-Hub is not responsible for misuse of this Letter of Membership Allotment. Third parties may verify the validity and genuity of this document by sending an email to [onboarding@t-hub.co](mailto:onboarding@t-hub.co).

Date of issue: 30-July-2021

Name of Spoc : Mr. Anil Kumar Puppala  
Name of member : Geethanjali College of Engineering and Technology  
[CIN/LLP ID: ]  
Billing Address : Geethanjali College of Engineering and Technology,  
Survey No. 33 & 34, Cheeryala (V) Keesara (M),  
Medchal Dist, Telangana – 501301.

Sub: Letter of Membership Allotment (LMA) – T-Tribe Annual Membership - Reg.

Thank you for reaching out to be part of T-Hub's startup community. Based on the interaction with you on the subject, we are pleased offer membership on the terms and conditions as set out hereunder.

### Section A – Specific Terms & Conditions (STC)

#### a) Details of membership

i. Membership No.	CMO-TTLP-031
ii. Type of Membership	Community Membership - Premium TTLP
ii) Effective date	01-Aug-2021
iii) Valid till	31-July-2022
iv) Subscription fee	INR 1,00,000(Rupees One Lakh Rupees only) + GST as applicable

#### b) Details of the Member

i) Name of Member	Geethanjali College of Engineering and Technology
ii) Constitution	Educational Society
iii) Billing address	Geethanjali College of Engineering and Technology, Survey No. 33 & 34, Cheeryala (V) Keesara (M), Medchal Dist, Telangana – 501301.
ii) Member GST Regn No.	NA
ii) Billing email id	<a href="mailto:principal@gcet.edu.in">principal@gcet.edu.in</a> , <a href="mailto:info@gcet.edu.in">info@gcet.edu.in</a>
iii) Paying member name	Principal, GCET
iv) Paying member contact no.	9866308257
v) Paying member email id	<a href="mailto:principal@gcet.edu.in">principal@gcet.edu.in</a> , <a href="mailto:info@gcet.edu.in">info@gcet.edu.in</a>
vi) Team name	Geethanjali College of Engineering and Technology

Geethanjali College of Engg. and Tech.  
Cheeryal (V), Keesara (M), Medchal Dist.(T.S.)-501 301.

## T-Hub Foundation

D.No. 2-53/23/2/1, IIT-Hyderabad Campus, Gachibowli, Hyderabad – 500 032, Telangana, India  
PAN: AAFC4112L GST Regn # 36AAFC4112L1ZB



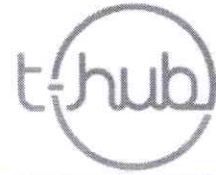

## Section B – General Terms & Conditions (GTC)

GENERAL TERMS AND CONDITIONS (GTC) of the Membership between T-Hub and the Member shall include as under:

1. **Effective Date:** The Effective Date would mean the date of receipt of Membership Fee from the Member.
2. **Term/ Duration of Usage:** This Agreement is valid for One (1) year from the effective date unless an extension as agreed mutually in writing is granted.
3. **Obligations of the Member:** Under this Agreement, the Member agrees, that when participating in or using the Services, the Member shall not:
  - a. use the Services in connection with contests, pyramid schemes, chain letters, junk email, spamming, or any duplicative or unsolicited messages (commercial or otherwise);
  - b. defame, abuse, harass, stalk, threaten or otherwise violate any other legal rights (such as rights of privacy and publicity) of others;
  - c. make any statements or comments of a defamatory or disparaging nature to any third-party regarding T-Hub, or any of the T-Hub officers, directors, employees, personnel, agents, policies, services or products, other than to comply with law.
  - d. publish, post, upload, distribute or disseminate any data that contains inappropriate, profane, defamatory, obscene, indecent or unlawful topic, name, material or information on or through T-Hub Services, servers, notice boards or spaces.
  - e. upload, or otherwise make available through Services, file that contains images, photographs, software or other material protected by intellectual property laws, including, by way of example, and not as a limitation, copyright, trademark laws (or by rights of privacy or publicity) unless the Member shall own or control the rights thereto or have received all necessary consent to do the same.
  - f. use any material or information, including images or photographs, which are made available through the Services in any manner that infringes any copyright, trademark, patent, trade secret, or other proprietary right of any party;
  - g. upload files through the Services that intentionally contain viruses, Trojan Horses, worms, time bombs, candlebots, corrupted files, or any other similar software or programs that may damage the operation of another computer or property of any other co-worker.
  - h. download any file through the Services that the Member knows, or reasonably should know, cannot be legally reproduced, displayed, performed, and or/distributed in such manner.
  - i. restrict or inhibit any other user from legitimately using and enjoying the Services.
  - j. violate any code of conduct or other guidelines which have been clearly communicated and mutually agreed that may be applicable for any Service.
  - k. harvest or otherwise collect information about other Members, including email addresses, without the authorization or consent of the disclosing party.
  - l. shall not involve in any illegal activity or business, cheating, illegal or unlawful act/omission and restrict itself from any illegal or unlawful activity or transaction.
  - m. violate any applicable laws or regulations in relation to utilizing the Services under this Agreement; or create false identity for the purpose of misleading others.
4. **Acknowledgement:** The Member expressly agrees and acknowledges to maintain healthy competition in the Community with other Members of T-Hub and not to act or involve in any malpractices, including but not limited to:
  - a. Gaining unauthorized access to any information including but not limited to confidential / proprietary information or intellectual property rights, directly or indirectly, of other Members and using in any manner, whatsoever in nature.
  - b. Soliciting employees of other Members / co-occupants, directly or indirectly, for its own benefits with malafide intentions and employing any person who was an employee of other Member / co-occupants of T-Hub. In the event, the Member wants to employ such person as referred herein, the Member shall ensure that such person receives a no-objection certificate (NOC) from his/her previous employer or Member / co-occupant of T-Hub. The Member shall not employ such person without him/her gaining NOC from the relevant party.

---

### T-Hub Foundation

D.No. 2-53/23/2/1, HIT-Hyderabad Campus, Gachibowli, Hyderabad – 500 032, Telangana, India

PAN: AAFCT4112L

GST Reg

Geethanjali College of Engg. and Tech.

Cheeryal (V), Keesara (M), Medchal Dist.(T.S.)-501 301.

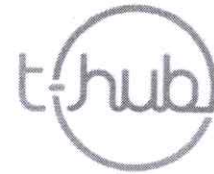

Agreement. In relation to all of the foregoing, the T-Hub agrees to the transfer, where appropriate, of such Confidential Information.

- c. All confidential information supplied by T-Hub remains the sole and exclusive property of T-Hub or the respective disclosing party. The Member acknowledges and agrees that nothing in this T&C or your participation or use of the Services will be construed as granting any rights, by license or otherwise, in or to any Confidential Information or any patent, copyright or other intellectual property or proprietary rights of T-Hub, or any participant or user of the Services.
- d. Any and all information of the Member, its affiliates or clients that is either disclosed to T-Hub or is acquired/ accessed by T-Hub pursuant to relationship established through this Agreement shall be kept by T-Hub in strict confidence, using such degree of care as is appropriate to avoid unauthorized access, use or disclosure. Further, T-Hub shall not disclose any such information to any third party without prior written approval of the Member, except that T-Hub reserves the right to disclose any such information to satisfy any applicable law, regulation, legal process or governmental request. T-Hub acknowledges and agrees that nothing in this under this Agreement will be construed as granting any rights, by license or otherwise, in or to any Confidential Information or any patent, copyright or other intellectual property or proprietary rights of the Member, its affiliates or clients.

The foregoing shall not prohibit or limit a party's use of information, including but not limited to ideas, concepts, know how, techniques and methodologies, which (a) is or becomes publicly available through no breach of this Agreement by the receiving party; (b) is released by the disclosing party to any other person, firm or company without restriction; (c) is rightfully obtained by the receiving party without restriction; (d) to the extent required by legal process and, to the extent not prohibited by law, with prior notice to the other party; (e) is rightfully already known to or is independently developed by the receiving party; or (f) is generally known or easily ascertainable by parties of ordinary skill in computer programming or design or in the business of the disclosing party.

8. **Disclaimer of Warranties:** To the maximum extent permitted by applicable law, T-Hub provides the SLAs Services "as is", and hereby disclaim with respect to the services all warranties and conditions, whether express, implied or statutory, relating to: merchantability or fitness for a particular purpose.
9. **Limitation of Liability and Remedies:** Pursuant to clause 6 under this Agreement, except in case of gross negligence or misconduct by T-Hub, its employees or its agents / representatives, T-Hub shall not be liable for any damages/loss or expenditures (direct or indirect) that the Member incur or may incur for any reason whatsoever (including, without limitation, all damages referenced above and all direct or general damages).
10. **Indemnification:** "The Member shall indemnify and hold T-Hub harmless from and against any loss, damage or liability of any sort whatsoever resulting from (i) any default in observing the terms and conditions of this Agreement and/or Lease, (ii) any wilful or negligent act on the part of the Member, its agents, employees, or invitees, or persons permitted on the Premises by the Member, and/or (iii) breach of any covenants under this Agreement or T-Hub policies or policies as attached under **Annexures** herein. The Member expressly agrees to waive, and agrees not to make any claim against T-Hub for damages, direct, consequential or otherwise, arising out of (i) any failure to furnish any service of Premises, any error or omission with respect thereto, any delay or interruption of same, (ii) injury to or death of persons in or about the Premises, (iii) loss or damage to the Member's property in or about the Premises, and (iv) claims arising by reason of the foregoing.
11. **General Conditions and Obligations of the Member:**
  - a. The Member agrees not to represent themselves as an employee or any form of representative of T-Hub in any business dealings.
  - b. The Member shall obtain prior approval in writing from T-Hub for any activities not covered under or reasonably related to the scope of this Membership.
  - c. The Member or his employees or Visitors shall be prohibited from making any actions or inactions that may be considered offensive in nature, including offensive glance, critique, contact or comment based on a person's race, sex, color, creed, religion, national/ethnic origin, age, handicap, sexual orientation or disabled veteran.
  - d. For clarity, notwithstanding anything to the contrary the obligations of the Member as specified above or anywhere else in this Agreement applies only to such extent that such obligations are within the sole control of the Member; they are not intended to make the Member responsible for any obligations or responsibilities which are within the control of either T-Hub.
  - e. The Member acknowledges that T-Hub has the right to use the name of the Member for the purpose of its promotional/marketing activities.
  - f. The Member shall abide by all applicable laws and the terms of this Membership including the policies under **Annexures** herein of this Agreement.

## T-Hub Foundation

D.No. 2-53/23/2/1, HIT-Hyderabad Campus, Gachibowli, Hyderabad - 500 032, Telangana, India  
PAN: AAFCT4112L GST Regn # 36AAFCT4112L1ZB

PRINCIPAL  
Geethanjali College of Engg. and Tech.  
Cheeryal (V), Keesara (M), Medchal Dist.(T.S.)-501 301.





the Member may terminate the Agreement without any notice and T-Hub shall reimburse the security deposit at the time of vacation of the Premises.

- b. If a party asserts Force Majeure as an excuse for failure to perform the party's obligation, then the non-performing party must prove that the party took reasonable steps to minimize delay or damages caused by such events, that the party substantially fulfilled all non-excused obligations, and that the other party was notified in time of the likelihood or actual occurrence of an event described in Force Majeure clause.
21. **Amendment:** No Party shall be bound by any modification or amendment of this Agreement unless such modification or amendment is set forth in a written instrument signed by both the Parties
22. **Anti-Bribery:** T-Hub represents that they have established policies and procedures relating to compliance with anti-bribery/anti-corruption laws and that it has an established code of ethics and/or code of conduct which inter alia prohibit bribery/corruption which must be mandatorily followed by the Member.

  
**PRINCIPAL**  
**Geethanjali College of Engg. and Tech.**  
**Cheeryal (V), Keesara (M), Medchal Dist.(T.S.)-501 301.**

---

## T-Hub Foundation

D.No. 2-53/23/2/1, HHT-Hyderabad Campus, Gachibowli, Hyderabad – 500 032, Telangana, India  
PAN: AAFCT4112L GST Regn # 36AAFCT4112L1ZB



# Geethanjali College of Engineering and Technology



(UGC Autonomous Institution Accredited by NBA & NAAC,  
Permanently Affiliated to JNTUH, ISO 9001:2015 certified)  
Cheeryal (V), Keesara (M), Medchal. Dist. 501301



## Circular

3<sup>rd</sup> Sept 2021

Incubation Center at GCET in association with T-HuB is organizing a pre-orientation session by T-HuB's capacity building team and the details of the session are as follows.

Zoom link:

<https://us02web.zoom.us/j/87216646713?pwd=T25hTStuT0NFZzdYc2lZL3VDUzFHQT09>

Topic: **T-Tribe - LaunchPad Program Pre-Orientation session**

Date & Time: **September 06<sup>th</sup>, 2021 @ 07:00 PM | India**

Meeting ID: **872 1664 6713**

Passcode: **692028**

After the session, T-HuB's team will be conducting for psychometric test. Students who are interested in getting involved in the innovation related activities at GCET's incubation center and/or at THuB can take up the psychometric test.

Only first 50 students will be selected by T-HuB's team based on the psychometric test results.

**PRINCIPAL**  
Geethanjali College of Engg. Tech.  
Cheeryal (V), Keesara (M), R.R. Dist. (A.P.) - 501301

Principal





Anil Kumar Puppala <apuppala@gcet.edu.in>

## List of Students from GCET interested in Launchpad program

Anil Kumar Puppala GCET <apuppala@gcet.edu.in>

Mon, Sep 20, 2021 at 3:49 PM

To: Harshitha Koganti <harshitha.koganti@t-hub.co>

Cc: uksusarla@gcet.edu.in

Harshitha:

Please find attached the list of students who expressed interest in the THuB's Launchpad program. They were selected from the list provided by THuB after the Psychometric Test.

Thanking You

Anil

On Mon, Sep 20, 2021 at 12:42 PM Anil Kumar Puppala GCET <apuppala@gcet.edu.in> wrote:

Harshitha Garu:

Please find attached the list of students from GCET for the launch pad program. This is the list from the students who passed the psychometric test (conducted by THuB) and who expressed interest in joining.

Thanking You

Anil

--

Anil Kumar Puppala Ph.D.

(State University of New York at Buffalo, New York)

Professor, Dept of EEE,

I/C Incubation Center,

Geethanjali College of Engineering and Technology

Mobile: +91 916 062 4935

 Interested\_students\_GCET.xlsx  
16K

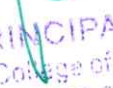
  
PRINCIPAL  
Geethanjali College of Engg. Tech.  
Cheeryal (V), Keesare (R), B.R. Dist. (A.P.) - 501 301



## Geethanjali College of Engineering and Technology

(UGC Autonomous Institution Accredited by NBA & NAAC  
Permanently Affiliated to JNTUH, ISO 9001:2015 certified)  
Cheeryal (V), Keesara (M), Medchal. Dist. 501301

*selected for*

### Students from GCET interested in the Launchpad Program

S. No	Name	Roll No.	Email Address	Phone	Rank as per THuB's List
1	Khushi Jha	20R11A0593	mukeshkumarjha1972@gmail.com	9618348974	1
2	Arya Kodte	20R11A6702	20r11a6702@gcet.edu.in	6301319056	2
3	Ananya Chepuri	20R11A0469	ananyachepurich@gmail.com	8317632910	3
4	Aryan Kodte	20R11A6703	20r11a6703@gcet.edu.in	8919559628	4
5	M.Chaithanya Lahari	20R11A6729	20r11a6729@gcet.edu.in	9390818377	5
6	HARI SARADA	20R11A05K9	hariharisarada@gmail.com	9490774651	6
7	Vellaturu Jayanth Sakar	20R11A0154	Jayanthsakar001@gmail.com	8978130604	7
8	Ashrith Gadeela	20R11A05J4	ashrith.gadeela@gmail.com	6309898687	8
9	YELLETI GEETHANJAL	20R11A04C0	geethanjalireddy492@gmail.com	9059164113	9
10	G . Harshitha	20R11A6618	20r11a6618@gcet.edu.in	6309381514	10
11	Chinthala Shivani	20R11A6711	chinthalashivani2003@gmail.com	8897592578	11
12	Pulipaka Ganesh	19R11A04D3	ganeshpvt0@gmail.com	8977880622	12
13	Asifa Anjum Shaik	20R11A0405	20r11a0405@gcet.edu.in	7815968799	13
14	Gunja Vijay Kumar	20R11A05E2	20r11a05e2@gcet.edu.in	9515352618	14
15	PEDADA UDAY KIRAN,	20r11a0443	20r11a0443@gcet.edu.in	7675827525	15
16	Richa Wakode	20R11A0544	20r11a0544@gcet.edu.in	9510657683	16
17	Reddy Suravaram Shreya	19R11A1250	shreyasuravaram9@gmail.com	9100204099	19
18	Bhoomika	20R11A04B6	bhoomikavallakati123@gmail.com	7396399679	21
19	Jinna Sridhar Reddy	20R11A0483	20r11a0483@gcet.edu.in	9391942161	22
20	Mohammed waseem tab	20R11A1242	20r11a1242@gcet.edu.in	9160564656	23
21	Aniketh kamlekar	20R11A05C6	anikethkamlekar@gmail.com	9381192595	24
22	Komatireddy Sathwik Pra	20r11a05e7	20r11a05e7@gcet.edu.in	7093331050	25
23	Sarika.D	20R11A6615	sarikasarika0750@gmail.com	8790490279	26
24	Abhiram gullapalli	20R11A6203	gullapalliabhiram860@gmail.com	9100028650	27
25	A.Shreya	20r11a0461	anantulashreya@gmail.com	7330616713	28
26	Sai Teja	20R11A6624	sirik6669@gmail.com	9398757938	29
27	Andem saitejaswini	20R11A0462	20r11a0462@gcet.edu.in	8309977422	30
28	R.Saunak jain	20r11a0444	saunakjain007@gmail.com	9491034822	31
29	Arkatala Keerthana	20R11A05C7	keerthana.ark0112@gmail.com	9391647441	32
30	Gajjala Sai Kiran	20R11A0476	20r11a0476@gcet.edu.in	6301278918	33
31	B.sai sanjay	19R11A0206	saisanjaybanala@gmail.com	9908541388	34
32	J Manish	20R11A0482	20R11A0482@gcet.edu.in	8919350401	35
33	Poorvi Jatoth	20R11A05N4	poorvijatoth1@gmail.com	6300038873	36
34	Srikanth patibandla	20R11A0232	20R11A0232@gcet.edu.in	7799696199	37
35	Barige. Adarsh	20R11A6213	adarshbarige@gmail.com	7013798746	38
36	M shatananda sharma	20R11A0492	Shathanandsharma@gmail.com	9985511311	39
37	Kapaka Sri Krishna Kous	20R11A05E5	20R11A05E5@gcet.edu.in	8008608060	40

*Principal*  
Geethanjali College of Engg. Tech.  
Cheeryal (V), Keesara (M), R.R. Dist. (A.P.) - 501301





Anil Kumar Puppala &lt;apuppala@gcet.edu.in&gt;

## T-Tribe - LaunchPad Program Pre-Orientation session\_ GCET \_ 06th Septemebr @ 07:00PM

20 messages

Harshitha Koganti &lt;harshitha.koganti@t-hub.co&gt;

Wed, Sep 1, 2021 at 4:10 PM

To: Anil Kumar Puppala GCET &lt;apuppala@gcet.edu.in&gt;

Cc: Ganesh Rayala &lt;ganesh.rayala@t-hub.co&gt;, principal@gcet.edu.in, Srinivas Bangaru &lt;srinivas.bangaru@t-hub.co&gt;, info@gcet.edu.in

Dear All,

Greetings of the day!

This is regarding the LaunchPad program pre-orientation session.

As requested by you we scheduled a pre-orientation session on Monday i.e, September 06th, 2021 @ 07:00 PM. Once the session is over we will share the psychometric test link with students so those who are interested can perform the test and based on the scores we will shortlist the students for the same.

### Meeting Details:

Topic: T-Tribe - LaunchPad Program Pre-Orientation session

Time: September 06th, 2021 @ 07:00 PM | India

Join Zoom Meeting

<https://us02web.zoom.us/j/87216646713?pwd=T25hTStuT0NFZzdYc2lZL3VDUzFHQT09>

Meeting ID: 872 1664 6713

Passcode: 692028

Please communicate the same with students for joining the session.

For any other queries please write to us.

Regards,  
Harshitha.

On Mon, Aug 9, 2021 at 12:28 PM Harshitha Koganti &lt;harshitha.koganti@t-hub.co&gt; wrote:

Dear Sir,

Greetings from T-Tribe!!!

We now officially welcome Geethanjali College of Engineering & Technology to be a part of the T-Tribe LaunchPad program, we are glad that Geethanjali College is one of our college partners here onwards.

As you are aware, **T-Tribe - Academic Membership Program** - is the latest and proud initiative of T-Hub launched with a vision to empower students across the country with entrepreneurship.

### How do we plan to achieve this?

We have various expertly curated programs to help aspiring entrepreneurs in every stage of their entrepreneurial journey. One of them is our one-year **Launchpad Program!** By associating with the leading colleges in the country, T-Tribe aims to deliver entrepreneurial content to the students and help them consider entrepreneurship as a career. The Launchpad Program is a perfect amalgamation of theoretical and practical learning that not only enlightens students on the scope of entrepreneurship but also gives them a direction to achieve success in the field.

### Why should you choose the Launchpad Program for your students?

ii) College/Institute (Pvt, Society)	Teja Educational Society
iii) Company/Institute CIN Number	Not applicable
ii) Billing address	<b>Geethanjali College of Engineering and Technology, Survey No. 33 &amp; 34, Cheeryala(V) Keesara(M), Medchal Dist. Telangana, India Pin Code-501301.</b>
ii) GST Regn No., if applicable	Not applicable
ii) Billing email id	principal@gcet.edu.in ; info@gcet.edu.in
iii) Paying member name	Principal, Geethanjali College of Engineering and Technology
iv) Paying member contact no. & email id	9866308257 principal@gcet.edu.in ; info@gcet.edu.in
v) Bank account cancelled cheque	principal@gcet.edu.in ; info@gcet.edu.in
vi) PAN	<u>AAATT7624B</u>

Please do the needful.

Thanks,  
Srinivas.

----- Forwarded message -----

From: **Anil Kumar Puppala GCET** <apuppala@gcet.edu.in>  
Date: Wed, Aug 4, 2021 at 3:28 PM  
Subject: Fwd: T-Tribe LaunchPad program proposal  
To: Ganesh Rayala <ganesh.rayala@t-hub.co>, <srinivas.bangaru@t-hub.co>  
Cc: Udaya Susarla <uksusarla@gmail.com>, <iic@gcet.edu.in>

Team T-Tribe:  
Please find attached the documents/information as asked for.  
Please let me know if you need any further information.

Thanking You  
Anil

**PRINCIPAL**  
Geethanjali College of Engg. Techn.  
Cheeryala (V), Keesara (M), K.R. Dist. (A.P.) - 501301

----- Forwarded message -----

From: **Mallesham Goud** <malleham1975@gmail.com>  
Date: Wed, Aug 4, 2021 at 11:30 AM  
Subject: Re: T-Tribe LaunchPad program proposal  
To: Anil Kumar Puppala GCET <apuppala@gcet.edu.in>

sir,  
PFA

On Tue, Aug 3, 2021 at 11:44 AM Anil Kumar Puppala GCET <apuppala@gcet.edu.in> wrote:



On Fri, Jul 30, 2021 at 3:48 PM Anil Kumar Puppala GCET <apuppala@gcet.edu.in> wrote:

Team T-Tribe at THuB:

Thank you for coming down to GCET for interacting with our team and explaining about the different academic programs that T-HuB is offering.

As discussed, GCET would like to get associated by signing up for the LaunchPad program initially and followed by a probable registration for Kickstart program at a later stage.

Please let us know further procedures.

Thanking You  
Anil

On Fri, Jul 30, 2021 at 1:58 PM Ganesh Rayala <ganesh.rayala@t-hub.co> wrote:

Hi Anil,

As discussed here are the proposals.

Thanks and Regards  
Ganesh

----- Forwarded message -----

From: **Srinivas Bangaru** <srinivas.bangaru@t-hub.co>

Date: Wed, Jul 7, 2021, 12:15 PM

Subject: T-Tribe LaunchPad program proposal

To: <praneethharsha.ce@gcet.edu.in>

Cc: Ganesh Rayala <ganesh.rayala@t-hub.co>, Chaitanya Shraavan <chaitanya.shraavan@t-hub.co>

Dear Mr. Praneeth,

Greetings from T-Tribe!

It was great talking to you today. As discussed, here I would like to share the LaunchPad program proposal for your kind perusal.

**T-Tribe** - Academic Membership Program - is the latest and proud initiative of T-Hub launched with a vision to empower students across the country with entrepreneurship.

**How do we plan to achieve this?**

We have various expertly curated programs to help aspiring entrepreneurs in every stage of their entrepreneurial journey. One of them is our one-year **Launchpad Program!** By associating with the leading colleges in the country, T-Tribe aims to deliver entrepreneurial content to the students and help them consider entrepreneurship as a career. The Launchpad Program is a perfect amalgamation of theoretical and practical learning that not only enlightens students on the scope of entrepreneurship, but also gives them a direction to achieve success in the field.

**Why should you choose the Launchpad Program for your students?**

The future is looking at more job creators than job seekers. We want the next generation of the country to be able to become successful entrepreneurs by implementing their revolutionary ideas. And their success journey starts with the Launchpad Program.

The following are the key outcomes of the program:

PRINCIPAL  
Geethanjali College of Engg. Tech.  
Chennai (V), Keesari P.O., Dist. (A.D.) - 501 201

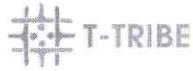

**Harshitha Chowdary**  
**Senior Associate | T-Tribe, T-Hub**  
**Contact: +91 9010839295**  
**Website: <https://t-hub.co>**



**Anil Kumar Puppala GCET** <apuppala@gcet.edu.in>  
To: Harshitha Koganti <harshitha.koganti@t-hub.co>

Wed, Sep 8, 2021 at 3:56 PM

Harshitha:

Thank You for your email. Continuing the telephonic conversation, we shall have the orientation session at 7:00PM today 8th Sept 2021.

Thank You  
Anil

On Wed, Sep 1, 2021 at 4:10 PM Harshitha Koganti <harshitha.koganti@t-hub.co> wrote:

Dear All,

Greetings of the day!

This is regarding the LaunchPad program pre-orientation session.

As requested by you we scheduled a pre-orientation session on Monday i.e, September 06th, 2021 @ 07:00 PM. Once the session is over we will share the psychometric test link with students so those who are interested can perform the test and based on the scores we will shortlist the students for the same.

**Meeting Details:**

Topic: T-Tribe - LaunchPad Program Pre-Orientation session

Time: September 06th, 2021 @ 07:00 PM | India

Join Zoom Meeting

<https://us02web.zoom.us/j/87216646713?pwd=T25hTStuT0NFZzdYc2lZL3VDUzFHQT09>

Meeting ID: 872 1664 6713

Passcode: 692028

Please communicate the same with students for joining the session.

For any other queries please write to us.

Regards,  
Harshitha.

--  
Anil Kumar Puppala Ph.D.

(State University of New York at Buffalo, New York)

Professor, Dept of EEE,

I/C Incubation Center,

Geethanjali College of Engineering and Technology

Mobile: +91 916 062 4935

  
**PRINCIPAL**  
Geethanjali College of Engg. Tech.  
Keesara (M), R.R. Dist. (A.P.) - 501 501

**Harshitha Koganti** <harshitha.koganti@t-hub.co>  
To: Anil Kumar Puppala GCET <apuppala@gcet.edu.in>

Thu, Sep 9, 2021 at 8:14 PM

Hello Sir,

As requested by you please find the attached recorded session video.



19R11A05N1@gcet.edu.in, 18R11A0233@gcet.edu.in, 19R11A0229@gcet.edu.in, 19R15A0205@gcet.edu.in, 19R11A0206@gcet.edu.in, 18R11A0221@gcet.edu.in, 18R11A02A6@gcet.edu.in, 20R11A0212@gcet.edu.in, 20R11A0202@gcet.edu.in, 20R11A0206@gcet.edu.in, 20R11A0223@gcet.edu.in, 20R11A0203@gcet.edu.in, 20R11A0219@gcet.edu.in, 20R11A0209@gcet.edu.in, 20R11A0238@gcet.edu.in, 20r11a0215@gcet.edu.in, 20r11a0221@gcet.edu.in, 20R11A0225@gcet.edu.in, 20R11A0210@gcet.edu.in, 20R11A0211@gcet.edu.in, 20R11A0229@gcet.edu.in, 20r11a0237@gcet.edu.in, 20R11A0239@gcet.edu.in, 20R11A0233@gcet.edu.in, 20R11A0213@gcet.edu.in, 20R11A0228@gcet.edu.in, 20R11A0226@gcet.edu.in, 20R11A0231@gcet.edu.in, 20r11a0205@gcet.edu.in, 20R11A0201@gcet.edu.in, 20R11A0232@gcet.edu.in, 20R11A0216@gcet.edu.in, 19R15A0315@gcet.edu.in, 18R11A04P6@gcet.edu.in, 18R11A0310@gcet.edu.in, 19R15A0222@gcet.edu.in, 18R11A0223@gcet.edu.in, 20R15A0206@gcet.edu.in, 20R15A03q9@gcet.edu.in, 20R15A0327@gcet.edu.in, 20R11E0046@gcet.edu.in, 20R11A6254@gcet.edu.in, 18R11A0241@gcet.edu.in, 17R15A0224@gcet.edu.in, 16R11A0240@gcet.edu.in, 20R11A0559@gcet.edu.in, 20R11A0558@gcet.edu.in, 18r11a0326@gcet.edu.in, 30r15a0313@gcet.edu.in, 18R11A0327@gcet.edu.in, 20R11A6720@gcet.edu.in, 20R11A6730@gcet.edu.in, 20R11A6229@gcet.edu.in, 20R11A6742@gcet.edu.in, 20R11A0402@gcet.edu.in, 20R11A0584@gcet.edu.in, 20R11A0585@gcet.edu.in, 20R11A05B0@gcet.edu.in, 19R11A1257@gcet.edu.in, 20R15A0122@gcet.edu.in, 20R11A05P1@gcet.edu.in, 19R11A0262@gcet.edu.in, 20r11a0411@gcet.edu.in, 20R15A0221@gcet.edu.in, 20R11A05J8@gcet.edu.in, 20r15a0304@gcet.edu.in, 20R11A0490@gcet.edu.in, 20R11A1259@gcet.edu.in, 20R11A0593@gcet.edu.in, 20R11A6213@gcet.edu.in, 20R11A6214@gcet.edu.in, 20R11A05C6@gcet.edu.in, 20R11A0218@gcet.edu.in, 20R11A0224@gcet.edu.in, 20R11A0234@gcet.edu.in

Dear All

Please find attached the Video recording of the orientation session by THuB that was held on 8th Sept 2021.

HyperLink to the psychotemtric test (FOR STUDENTS ONLY) will also be shared with you separately, which will be active only for 24 Hrs. Please remember that only 50 students will be shortlisted **By THuB's team. The test is being conducted by THuB's team and will be evaluated by them alone.**

Dear faculty,

Due to exams in some departments, although some of the students registered for the events, they were unable to attend the live orientation session last week, hence it is requested to send this video link. Please pass this information to students.

This email is also forwarded to the registered candidates ([rollnumber@gcet.edu.in](mailto:rollnumber@gcet.edu.in). About 365 students registered for this orientation session). Although students who did not register but want to attend, can still listen to the recording and take the test.

Please instruct the students in your respective departments to

- login into email,
- watch the video
- and take the psychometric test

Thank You  
Team-Incubation Center.  
**GCET**

[Quoted text hidden]

Mail Delivery Subsystem <mailer-daemon@googlemail.com>  
To: apuppala@gcet.edu.in

Mon, Sep 13, 2021 at 2:53 PM



### Address not found

Your message wasn't delivered to **19R11A0483@gcct.edu.in** because the domain gcct.edu.in couldn't be found. Check for typos or unnecessary spaces and try again.

**PRINCIPAL**  
Geethanjali College of Engg. Tech.  
Cheeryal (V), Keesara (M), R.R. Dist. (A.P.) - 501 301





**INTERNATIONAL PLANETARY AERIAL SYSTEMS CHALLENGE**  
 "Propelling Exploration"

**CERTIFICATE OF PARTICIPATION**

This certificate is presented to

**Abhishek Bhemisetty**

of

**Team Vayujith**

for participating in the International Planetary Aerial Systems Challenge,  
 organised by Mars Society South Asia during March 10 - May 5, 2021

*Sagar Dhaka*

**SAGAR DHAKA**  
 President, MSSA

*Justyna Pelc*

**JUSTYNA PELC**  
 Judge, IPASC 2021

**PRINCIPAL**  
 Geethanjali College of Engg. and Tech.  
 Cheeryal (V), Keesara (M), Medchal Dist.(T.S.)-501 301.





MARS SOCIETY  
SOUTH ASIA



IPAS CHALLENGE

## INTERNATIONAL PLANETARY AERIAL SYSTEMS CHALLENGE

"Propelling Exploration"

# CERTIFICATE OF PARTICIPATION

This certificate is presented to

**Sai Krupa Chary Arendra**

of

**Team Vayujith**

for participating in the International Planetary Aerial Systems Challenge,

organised by Mars Society South Asia during March 10 - May 5, 2021

**SAGAR DHAKA**  
President, MSSA

**JUSTYNA PELC**  
Judge, IPASC 2021

**PRINCIPAL**  
Geethanjali College of Engg. and Tech.  
Cheerla (V), Keesara (M), Medchal Dist.(T.S.)-501 301.





MARS SOCIETY  
SOUTH ASIA



IPAS CHALLENGE

## INTERNATIONAL PLANETARY AERIAL SYSTEMS CHALLENGE

"Propelling Exploration"

# CERTIFICATE OF PARTICIPATION

This certificate is presented to

**Srija**

of

**Team Vayujith**

for participating in the International Planetary Aerial Systems Challenge,

organised by Mars Society South Asia during March 10 - May 5, 2021

SAGAR DHAKA  
President, MSSA

JUSTYNA PELC  
Judge, IPASC 2021

**PRINCIPAL**

Geethanjali College of Engg. and Tech.  
Cheeryal (V), Keesara (M), Medchal Dist.(T.S.)-501 301.





MARS SOCIETY  
SOUTH ASIA



IPAS CHALLENGE

## INTERNATIONAL PLANETARY AERIAL SYSTEMS CHALLENGE

"Propelling Exploration"

# CERTIFICATE OF PARTICIPATION

This certificate is presented to

**K Vamshi Krishna**

of

**Team Vayujith**

for participating in the International Planetary Aerial Systems Challenge,

organised by Mars Society South Asia during March 10 - May 5, 2021

**SAGAR DHAKA**  
President, MSSA

**JUSTYNA PELC**  
Judge, IPASC 2021

  
**PRINCIPAL**  
Geethanjali College of Engg. and Tech.  
Cheerai (V), Keesara (M), Medchal Dist.(T.S.)-501 301.





MARS SOCIETY  
SOUTH ASIA



IPAS CHALLENGE

# INTERNATIONAL PLANETARY AERIAL SYSTEMS CHALLENGE

"Propelling Exploration"

## CERTIFICATE OF PARTICIPATION

This certificate is presented to

**T Vishnuvardhan Reddy**

of

**Team Vayujith**

for participating in the International Planetary Aerial Systems Challenge,



organised by Mars Society South Asia during March 10 - May 5, 2021

**SAGAR DHAKA**  
President, MSSA

**JUSTYNA PELC**  
Judge, IPASC 2021

PRINCIPAL  
Geethanjali College of Engg. and Tech.  
Chennai (V), Keeranur (M), Madhav District (T.S.)-601 301.



**INTERNATIONAL PLANETARY AERIAL SYSTEMS CHALLENGE**  
"Propelling Exploration"

19. TEAM EKYAM	422.56
20. SPARROW	412.63
21. AIRNOVA	407.57
22. RENAISSANCE	394.42
23. TEAM CIPHER	303.10
24. DYNAMICS	259.27
25. VAYUJITH	214.41
26. MITRA	166.31



marsociety.southasia Follow

regions band together virtually to create their innovative UAV designs, learning and exploring their creative faculties in the process.

This year's challenge as the scores suggest, was very tight. With so many teams delivering top quality reports, we had a tough time studying the nuances of each design and accurately appropriate scores to the teams.

Kudos to all the participants who turned in their reports!

After thorough evaluation, the top 3 teams for IPAS Challenge 2021 are:

1. Team Legendary - @legendaryrzeszow
2. DJS Antariksh - @djs\_antariksh
3. Team Technomats



490 likes



PRINCIPAL  
of Engg. and Tech.  
Vellore Institute of Technology  
VIT-VEP  
Vellore, Tamil Nadu, India



# Mentor talk

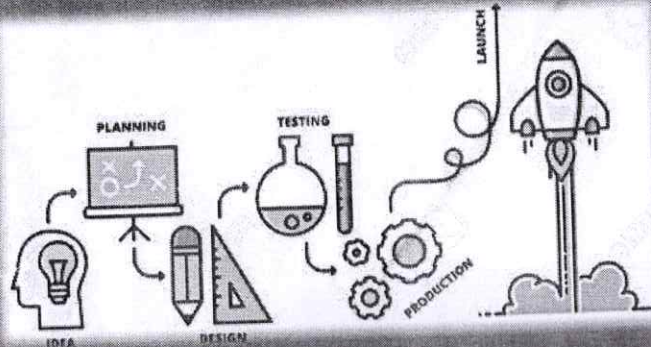

**Build your Idea into Business**  
A talk for Early Start Entrepreneurs  
Dt. 18.07.2021. Time: 10.30 am – 12 pm

Open to all the children till the age of 18 years

Join the session using Google meet link at

<https://meet.google.com/chz-jmwc-huq?authuser=0&hl=en>

Call / WhatsApp: +91-630 379 9742

Email : [contact@skilleduvarsity.com](mailto:contact@skilleduvarsity.com)

[www.skilleduvarsity.com](http://www.skilleduvarsity.com)

An initiative by SkillEdu VARSITY to provide interactive holistic learning platform for school & college students with the experts from industry, research organisations and academia for *Beyond Classroom Learning!*



India's successful Early Starters



Dr. Anil Kumar Puppala

**Academics:**

- Electrical Engineer from Osmania University, 2001
- M.S and Ph.D degrees from State University of New York at Buffalo (SUNY-UB) in 2004 and 2007. His research area at SUNY-UB was in Superconductor Machines

**Work experience:**

- K&H Industries New York as Research Engineer until 2009.
- Hical Technologies Bengaluru as Design Manager
- Currently In-charge of Incubation center at Geethanjali College of Engineering and Technology and Professor in Electrical and Electronics Engineering Department
- Also managing his family owned 'precision machining' industries at Kushaiguda Industrial Area and at Adibhatla.

**Recognition:**

An 'innovation ambassador' recognized by Ministry of Education, Govt. of India

**SkillEdu VARSITY**  
world's first skill education meta varsity

PRINCIPAL  
Geethanjali College of Engg. and Tech  
Chennai (W), Besant (M), Medchal Dist (T.S.),-501 3



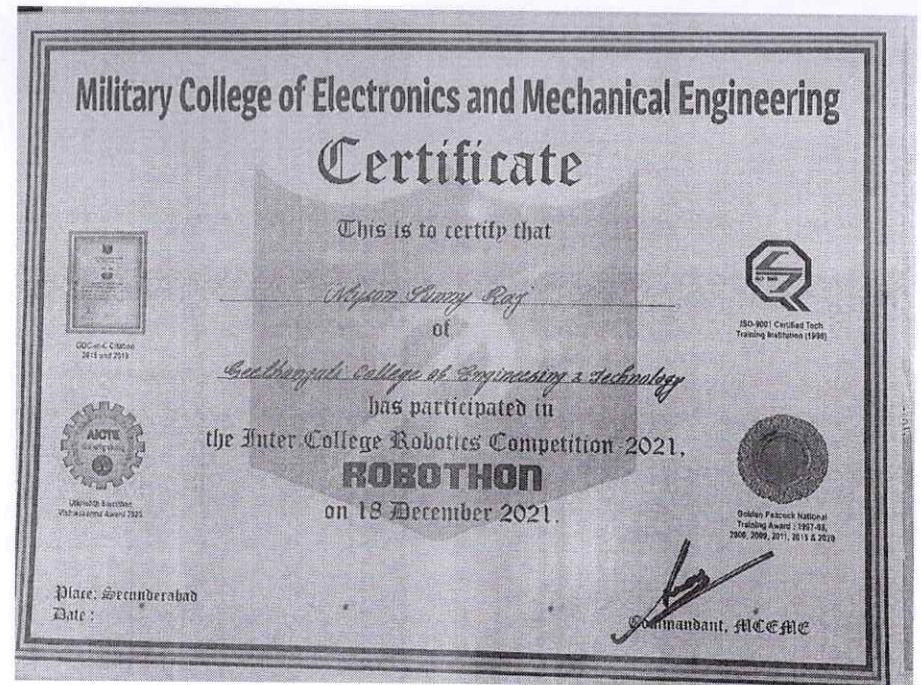
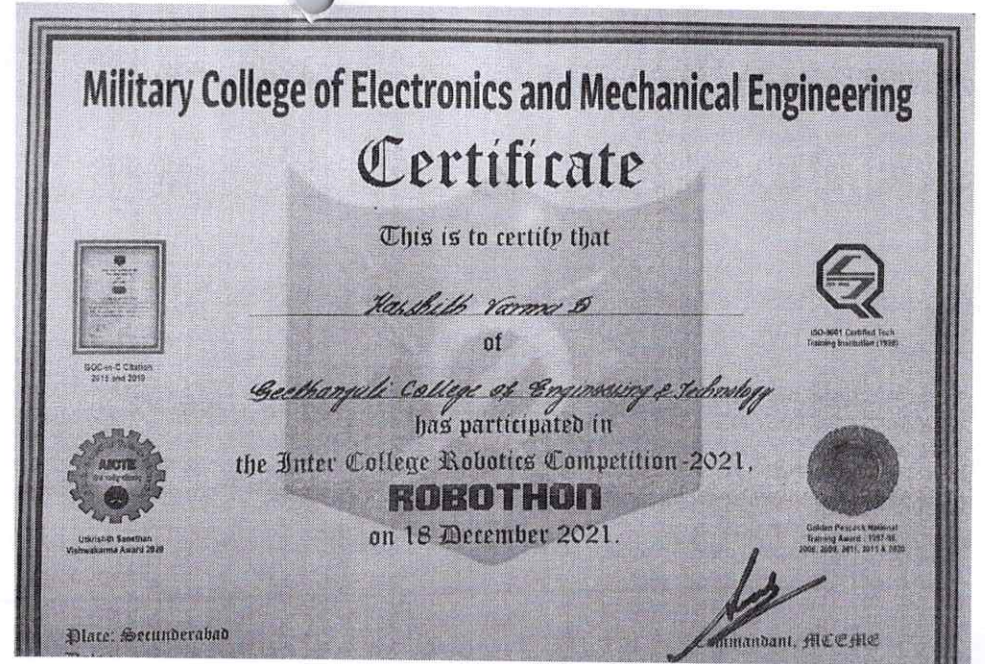



# Military College of Electronics and Mechanical Engineering

## Certificate

This is to certify that

*Geethy Abhinav*  
of

*Geethanjali College of Engineering & Technology*  
has participated in  
the Inter College Robotics Competition -2021,  
**ROBOTHON**  
on 18 December 2021.



GOC-in-C Citation  
2015 and 2019



Utkrishth Sansthan  
Vishwakarma Award 2020



ISO-9001 Certified Tech  
Training Institution (1998)



Golden Peacock National  
Training Award : 1997-98,  
2006, 2009, 2011, 2015 & 2020

Place: Secunderabad  
Date :

*[Signature]*  
Commandant, MCEME

Geethanjali College of Engg. and Tech.  
Cheerla (V), Keasara (M), Medchal Dist.(T.S.)-501 301.





**INNOVATION CELL**  
(Government of India)



**Ministry of Education**  
(Government of India)



**ATAL RANKING OF INSTITUTIONS  
ON INNOVATION ACHIEVEMENTS**

# Certificate of Recognition

This is to certify that

**GEETANJALI COLLEGE OF ENGINEERING & TECHNOLOGY**

is recognised in the band "EXCELLENT" under the category  
"Colleges/Institutes (Private / Self Financed) (Technical)"  
in Atal Ranking of Institutions on Innovation Achievement (ARIIA) 2021,  
a flagship program of the Ministry of Education, Government of India.

29th December 2021.

**Dr. Anil D Sahasrabudhe**  
Chairman, AICTE

**Shri K Sanjay Murthy**  
Secretary (HE), MoE

**Dr. Abhay Jere**  
Chief Innovation Officer  
MoE's Innovation Cell

Geetanjali College of Engineering & Technology  
Geeta Road, Karamba, Bangalore - 560075



## Geethanjali College of Engineering and Technology

(UGC Autonomous Institution Accredited by NBA & NAAC,  
Permanently Affiliated to JNTUH, ISO 9001:2015 certified)  
Cheeryal (V), Keesara (M), Medchal. Dist. 501301

### Mentors empanelled by the incubation center to help student innovators/entrepreneurs.

The incubation center is working under the guidelines of Institution Innovation Council (IIC), Ministry of Education and JHuB, Jawaharlal Nehru Technological University Hyderabad (JNTUH).

It has adopted the National innovation and Start up policy (NISP) for encouraging and nourishing the innovation quotient and entrepreneurial abilities of the students coming with innovative ideas and also to improve the employability levels of the other interested students. The incubation center invites ideas not only from students, faculty but also from any individuals of any nationality! Appropriate ideas, after short listing, will be seed funded by GCET and hand-held for securing funding opportunities and progress to the next level.

An expert committee to guide and mentor the incubatees is constituted with a mix of eminent personalities coming from different backgrounds viz., serial entrepreneurs, venture capitalists, industrialists, alumni at important positions and enthusiastic faculty.

Name	Designation	Positions Held
Dr. S. Udaya Kumar	Principal	Professional teaching experience in New Zealand, Ethiopia, Morocco and India for more than 36 years. Had his Bachelors, two M.Tech degrees and Ph.D degree from universities from India and New Zealand. Held several positions as Principal, Deputy director. He is also a reviewer of Scopus and Web of Science Indexed journals published from USA, Honk Kong, Taiwan.
Dr. Anil Kumar Puppala	Convener and I/C Incubation center GCET	M.S., Ph.D from State University of New York at Buffalo. Held positions as R&D Design Engineer at K&H Industries New York, Design Manager at Hical Technologies Bengaluru India, Managing Director at Vijetha Engineering Industries and Vijetha Integrated Systems (family owned and managed companies)
Mr. Srinivas Pothapragada	Entrepreneur	Serial Entrepreneur and Angel Investor. Founder of 'Sanovi' (based out of Boston USA) which was bought by IBM. Sanrise® Group Inc., the world's leading storage service provider with presence in over 18 countries, based out of Dublin, California. Srinivas helped Sanrise secure over \$215 Million in equity participation. Sanrise delivered the world's first Virtual Storage Appliance platform and a leading storage management software suite (now part of DELL/EMC).
Mr. Lolla Srinivas	Entrepreneur	M.S from Harvard University, Currently with Bees Consultancy



Mr. Sri Charan Lakkaraju	Entrepreneur	Founder StuMagz.com student motivator, Forbes 30 under 30 listed in 2018
Mr. SPV Reddy	Alumni/Entrepreneur	Presently with National Cyber Defence Research Center (NCDRC)
Mr. Ramesh RamGopal	Alumni/Entrepreneur	CEO <a href="http://www.techfeo.com">www.techfeo.com</a> IT services provider.
Mr. Bharath	Entrepreneur/Investor	Retired from Indian Air-force. Entrepreneur and Investor
Dr. Nagamani	Faculty, English Dept, GCET	Coordinator of Centre for Soft Skills Development at GCET. Instrumental in helping students imbibe Creative and Critical Thinking by applying 'Design Thinking' methodologies.
Dr S Shyam Kumar	Faculty, HoD, Dept of ME	Formerly headed the 'Applied Research Centre' at Ambala college of engineering and applied research, Ambala cantonment (State of Haryana) and consultant to 17 small scale industries nearby for product development during 2007 - 11. Also worked as consulting head- R&D in AI/ML at Fusion Technologies, Hyderabad 2020-21.
Mr. Ravi Kanth	Faculty, MBA Dept	An Engineering graduate from REC Warangal (Presently NIT Warangal) with Masters in Business Administration having 25 years of IT Industry experience managing large complex projects on multiple technologies working in India, USA and UK. Certified PMP.
Dr. Sita Madhavi	Faculty, MBA Dept	Co-coordinator for Entrepreneurship Development Cell along R&D-MBA Dept. Supports students in designing Business Models.
Mr. Ogirala Siva Kumar – Faculty	Faculty, CSE Dept	Formerly with AMD R&D Centre (I) Pvt. Ltd as Project Manager, Infineon Tech. India Pvt. Ltd as ASIC Design Manager, Intel India Design Centre 2001-03 as Lead Design Engineer, Motorola India Design Centre 1998-11, Technical staff Cadence Design Systems 1996-98, and as Scientist "C" Research Centre Imarat (RCI), DRDO 1992-96
Dr. Harsha Praneeth	Faculty, CE Dept	Associate Professor, Department of Civil Engineering, also a Co-founder for a social startup – Allika Pvt. Ltd.
Dr. GaganDeep Arora	Faculty, CSE Dept	Formerly with Institute of Technology and Science (ITS), Noida, UP. He was instrumental in establishing Incubation center with an INR 2.5 Cr grant and helped about 11 startup incubatees at ITS.
ValliSree	Faculty, ECE Dept	Department of Electronics and Communication Engineering Formerly as Technical Test Lead Independent Validation Solutions & Infosys Ltd. 12-07-2004 to 21-08-2012
Dr. Madhuri Bayya	Faculty, EEE Dept	Formerly worked at BITS-Pilani Hyderabad campus. Establishing labs in electrical domain is the specialty. Domain expertise in Electric Vehicles. Associated with startup Automotive wheels Pvt. Ltd. Executive member of IEEE PES Hyd. Section.
Mr. Subrhamaniam	Faculty, ECE Dept	Department of Electronics and Communication Engineering, Formerly with Sree 'V' Link Teleservices 2001-02 as Technician and as Technician & Supervisor IRSO,SDSC-SHAR, Sriharikota 2003-05.'

  
**PRINCIPAL**  
 Geethanjali College of Engg. and Tech.  
 Cheeryl (V), Keesara (M), Medchal Dist.(T.S.)-501 307







Anil &lt;apuppala@gmail.com&gt;

## Re: Hackathon at Geethanjali college

1 message

Srinivas P &lt;sri8080@yahoo.com&gt;

Sun, Aug 16, 2020 at 12:07 PM

To: Anil Kumar Puppala &lt;apuppala@gmail.com&gt;

Cc: Srinivas P &lt;sri8080@yahoo.com&gt;, Uday Kumar Susarla &lt;uksusarla@gmail.com&gt;, Yvn Phanikishore &lt;yvnphanikishore@gmail.com&gt;, ravinder reddy gaddam &lt;greddy1962@yahoo.co.in&gt;

**My pleasure to be of assistance**

Sent from BlueMail

On Aug 16, 2020, at 9:49 AM, Anil Kumar Puppala &lt;apuppala@gmail.com&gt; wrote:

Pothapragada Garu:

Hope you are doing well!

As the incharge of the Incubation (actually a preincubation) center at Geethanjali College of Engineering and Technology, I definitely had observed the indelible impression that your words had left on our students in the early last year. Some of our students had come up with ideas that won accolades at even national level podiums in this short span.

Graduating to the next step, **we at Geethanjali, would like to formulate a policy on 'Innovation and startups'.** I would consider my students to be very fortunate and blessed if you could kindly consider being in the committee for framing the policy.

Thanking you

Anil

On Wed, Jan 9, 2019 at 3:26 PM Anil Kumar Puppala &lt;apuppala@gmail.com&gt; wrote:

Pothapragada Garu:

Thank you for coming to speak to our students!

Your word on 'important person' in one's life or in a society - "Person who has identified a problem and has given a solution is the most important person" has truly inspired our students! This was evident even after working for 36 hours! They were all with excitement and enthusiasm that you had filled in, in your introductory speech - your words at the start, were like an elixir or a potion that made them sit for the 36 hours!

Thank You again!

Anil

Convener

Team Hackathon

On Thu, Jan 3, 2019 at 11:53 AM Srinivas P &lt;sri8080@yahoo.com&gt; wrote:

Should be there.

Ponnekanti will send the picture

Sent from BlueMail

Sent from BlueMail

On Dec 23, 2018, at 3:25 PM, Anil Kumar Puppala &lt;apuppala@gmail.com&gt; wrote:

Pothapragada Garu:

Thank you for taking my call this morning.

As I spoke to you over the phone, Geethanjali College of Engineering and Technology is organizing a national level 36hrs Hackathon in association with JHUB (JNTUH's innovation hub) on 5th and 6th of January, 2019.



PRINCIPAL

Geethanjali College of Engg. and Tech.

Cheeryal (V), Kosara (M), Medchal Dist.(T.S.)-501 301.





**SPV Reddy** ✓  
CEH,ECSA,OSCP,CISM,  
spvreddy.github.io Cy  
Penetration Testing

Telangana, India · Contact  
500+ connections

2 mutual connect

Message More

**SPV Reddy** ✓

**SPV Reddy** ✓ · 1st  
CEH,ECSA,OSCP,CISM,CCSP Product Security spvreddy.github.io Cyber  
Security - Penetration Testing

AUG 19, 2020



**Anil Puppala** · 3:15 PM

Hi,  
I am Anil Puppala, faculty at Geethanjali College and also Incharge  
of Incubation center here at GCET. Alumni coordinator has shared  
your details. **We are forming a committee for framing a policy on  
Innovations and Startups at our incubation center. Can u consider  
being a member in the committee?**



**SPV Reddy** ✓ · 3:15 PM

yes

Write a message...

📎 GIF 😊

Send

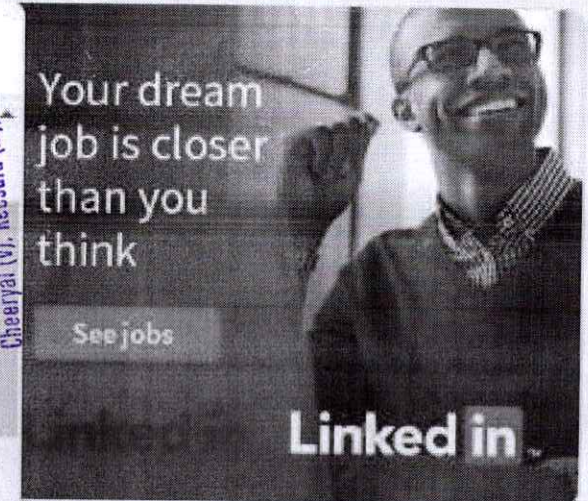

People also viewed



**Uma Maheshwar Reddy** · 2nd  
Mechanical Engineer | Master's  
Certification in Hybrid Electric Vehicle...

Connect



Messaging

PRINCIPAL  
Geethanjali College of Engg. and Tech.  
Cheeraj (V), Keesara (M), Medchal Dist.(T.S.)-501 304.



Anil &lt;apuppala@gmail.com&gt;

**Re: Request for acceptance - As Committee member - Incubation center at GCET**

1 message

Udaya Susarla <uksusarla@gmail.com>  
To: Anil Kumar Puppala <apuppala@gmail.com>

Tue, Aug 18, 2020 at 6:31 PM

On Tue, 18 Aug 2020 at 5:01 PM, Anil Kumar Puppala <apuppala@gmail.com> wrote:  
FYI

----- Forwarded message -----

From: **Anil Kumar Puppala** <apuppala@gmail.com>  
Date: Mon, Aug 17, 2020 at 11:50 AM  
Subject: Request for acceptance - As Committee member - Incubation center at GCET  
To: <lolla@ieee.org>  
Cc: <incubations-at-geethanjali@googlegroups.com>

Lolla Garu:

Thank you for taking my call this morning and thank you also for agreeing to be a part of the committee at the Incubation center at GCET.

As discussed, Geethanjali would like to first frame a policy on 'Innovation and Startups' so that the projects that our students are working on...which are winning accolades at state and national level, can be turned to commercial scale and ultimately be useful for the society at large.

Thanks again!  
Anil--  
Anil Kumar Puppala Ph.D.  
(State University of New York at Buffalo, New York)  
Professor, Dept of EEE,  
I/C Incubation Center,  
Geethanjali College of Engineering and Technology  
Mobile: +91 916 062 4935--  
Anil Kumar Puppala Ph.D.  
(State University of New York at Buffalo, New York)  
Professor, Dept of EEE,  
I/C Incubation Center,  
Geethanjali College of Engineering and Technology  
Mobile: +91 916 062 4935  
**PRINCIPAL**  
**Geethanjali College of Engg. and Tech.**  
Cheeryal (V), Keesara (M), Medchal Dist.(T.S.)-501 301.



Additional equipment provided for incubation (20-21)

S.N.	Item	Quantity	Details
1	Cadence EDASoftware	05 Licenses	UG Bundle Analog and Digital FE & BE
2	Xilinx VivadoSoftware	10 Licenses	For system design and simulation forXilinx
3	Xilinx Zynq –Zybo Boards	One	For system design using Xilinx FPGA
4	Spartan 3 CPLD/FPGA	05 kits	For hardware implementation of logicusing
5	Computers	05	Acer Veriton M200-i3
6	XilinxISE 9.2i	Perpetuallicenses	For system design and simulation forXilinx
7	Solder station	1	Soldering and desoldering station
8	USB Oscilloscope	1	2 Channel , mini oscilloscope.
	Training and awarenesss		

- Raspberry Pi, Cambridge University Workbook, Reference materials onSensors, training kits on Arduino. Arduino Boards, Raspberry Pi Boards,GSM Module, GPS Module, different types of sensors.
- Software tools like Keil, Proteus, Arduino IDEand Raspbian OS.
- Sensors:
  - IR, PIR, Temperature and Humidity, Pressure, Vibration, Ultrasonic, PH Pulse, temperature, Soil Moisture, LDR, Rainfall, Wind flow, Water flow Water level, Colour, Smoke/gas/alcohol, Proximity, Tilt, Gyroscope, Fire, Eye blink, Accelerometer, Finger print, Sound
- Actuators and switches
  - DC motor-5v, DC motor-12v, Motor driver, Stepper motor, Servo motor-180d, Servo motor-360d, LEDs, LCD, 7-segment display, Push button switches, Key pad Rack and pinion, Relays, Limit switches, Communication Interfaces, Zigbee, RFID Tag and Reader, RF Transmitter and Receiver, Bluetooth, Microcontroller Development Boards Arduino, Node MCU, Raspberry Pi, ARM 7,8501.



# AGINENT TECHNOLOGIES

....complete educational lab solutions

## TAX INVOICE

#35-149/1, Plot No 83, Near Brindavan Colony

Neredmet "X" Roads

HYDERABAD - 500056

☎ 9849688633, 9866239613

✉ aginent@yahoo.com

aginenttech@gmail.com

GSTIN: 36AXXPP1045J1ZX

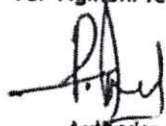
Details of Customer (Billed To)		Shipping Address			
Geethanjali College of Engineering and Technology Sy.No.33&34 Cheeryal(V)Keesara(M) Medchal Dist Pin:501 301 Ref:GCET/EEE PROJECT/PO/079/19-20 Dated 3/2/20		Geethanjali College of Engineering and Technology Sy.No.33&34 Cheeryal(V)Keesara(M) Medchal Dist Pin:501 301			
INVOICE NO:	MS/AT/19-20/11	DATE	25-02-2020		
S.NO.	DESCRIPTION	HSN CODE	QTY.	Unit RATE	TOTALAMOUNT
1	50 Mhz 4 Channel Oscilloscope	9030	1	58,500.00	58,500.00
2	3/10 Mhz Function Generator	9030	1	10,000.00	10,000.00
3	Soldering and De Soldering Staton	9030	1	4,428.00	4,428.00
Taxable Amount:72,928.00		Total Amount			72,928.00
		Add : GST		5%	3,646.40
		Grand Total			76,574.40
<b>TOTAL AMOUNT</b>					
Rupees : Seventy Six Thousand Five Hundred and Seventy Four only E. & O.E. Subject to Hyderabad Jurisdiction. PAN No. :AXXPP1045J				For Aginent Technologies  Authorised Signatory	

*M*

Authorised Distributor for

Sciencetech



**PRINCIPAL**

Geethanjali College of Engineering and Technology  
(Autonomous)

Cheeryal (M), Medchal Dist. T.S.R.

Scanned with CamScanner





# AGINENT TECHNOLOGIES

...complete educational lab solutions

## TAX INVOICE

#35-149/1, Plot No.83, Near Brindavan Colony  
Neredmet "X" Roads  
HYDERABAD - 500056

☎ 9849688633, 9866239613

✉ aginent@yahoo.com  
aginenttech@gmail.com

GSTIN: 36AXPP1045J1ZX

<b>Details of Customer(Billed To)</b> Geethanjali College of Engineering and Technology Sy.No.33&34 Cheeryal(V)Keesara(M) Medchal Dist Pin:501 301 Ref:GCET/EEE PROJECT/PO/079/19-20 Dated 3/2/20		<b>Shipping Address</b> Geethanjali College of Engineering and Technology Sy.No.33&34 Cheeryal(V)Keesara(M) Medchal Dist Pin:501 301	
---	--	---	--

INVOICE NO:	MS/AT/19-20/11	DATE	25-02-2020
-------------	----------------	------	------------

S.NO.	DESCRIPTION	HSN CODE	QTY.	Unit RATE	TOTALAMOUNT
1	Customized Work Station	9030	1	25,000.00	25,000.00
2	50 Mhz 4 Channel Oscilloscope	9030	1	58,500.00	58,500.00
3	3/10 Mhz Function Generator	9030	1	10,000.00	10,000.00
4	Soldering and De Soldering Staton	9030	1	12,000.00	12,000.00

Purchase & Stores  
Goods Received  
GR No. 549  
Date 11-6-2020

Taxable Amount: 1,02,335.00

Purchased by P&S  
Inspected by K. K. K.  
Verified by \_\_\_\_\_

Total Amount	1,05,500.00	
Discount@3%	3,165.00	
Total Amount	1,02,335.00	
Add : GST	5%	5,117.00
Grand Total	1,07,452.00	

TOTAL AMOUNT

Rupees : One Lakh Seven Thousand Four Hundred and Fifty Two only  
E. & O.E.  
Subject to Hyderabad Jurisdiction.  
PAN No. :AXXP1045J



For Aginent Technologies  
[Signature]  
Authorised Signatory

chel  
12/6/20  
12/6/20

Principal  
Geethanjali College of Engineering and Technology  
(Autonomous)  
Cheeryal (V), Keesara (M), Medchal Dist. (T.S.) - 501 301

Authorised Distributor for  
Scientech





# thingbits

PAID

## Invoice

# 1727032203

Thingbits Electronics Pvt. Ltd  
104, Ecstasy Business Park, Nirmal City of  
Joy  
JSD Road, Mulund West Mumbai  
Maharashtra 400080 India  
GSTIN 27AAGCP1304B1Z2

Bill To  
**Anil Kumar Puppala**  
Plot No. 116 Road No. 5 Nagarjuna Nagar Colony Post ECIL  
Hyderabad 500062 Telangana India

Ship To  
Geethanjali College of Engineering and  
Technology, Cheerya Village, Keesara  
Mandal, Ranga Reddy District Opposite  
Pathcare labs, Cheeryal  
Hyderabad 501301 Telangana India

Invoice Date : 26/08/2020  
Terms : Due On Receipt  
Due Date : 26/08/2020  
Order # : R795081122

Place Of Supply: Telangana (36)

#	Item & Description	HSN/SAC	Qty	Rate	IGST	Amount
1	Raspberry Pi 4 Model B - 8GB RAM	8471	1.00 NOS	5,899.00	1,061.82 18%	5,899.00
2	Raspberry Pi 4 Official 15W USB C Power Supply	8501	1.00 NOS	599.00	107.82 18%	599.00
3	Micro HDMI to Standard HDMI Cable for Raspberry Pi 4	8544	1.00 NOS	365.00	65.70 18%	365.00
4	Micro USB to USB C adapter	8544	1.00 NOS	79.00	14.22 18%	79.00
5	Shipping Fee	9968	1.00	0.00	0.00 18%	0.00

Sub Total 6,942.00

IGST18 (18%) 1,249.56

**Total ₹8,191.56**

Total in Words: **Rupees Eight Thousand One Hundred Ninety-One and Fifty-Six Paise Only**

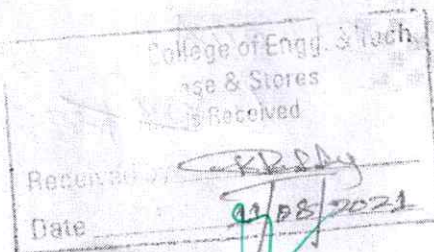

*[Signature]*  
Authorized Signature

*[Signature]*  
**PRINCIPAL**  
Geethanjali College of Engineering and Technology  
(Autonomous)  
Cheerya (M), Keesara (M), Nirmal Dist. (T.S.)

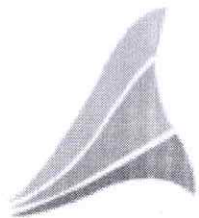

# ARIIA

## ATAL RANKING OF INSTITUTIONS ON INNOVATION ACHIEVEMENTS



**MoE**  
Ministry of Education  
Government of India

Verification Submitted Institute Data for Atal Ranking of Institutions on Innovation Achievements (ARIIA) - 2020-21

Institute Name: Geetanjali College of Engineering & Technology [ARI-C-19593]

List all the departments / centers / units are part of innovation and startup ecosystem of the institute

Srno	Department / Center / Unit Name	Type of Department / Center / Unit	Mention the Stream / Discipline / Sector of focus	Department / Center / Unit Level	Program Type	Student / Beneficiary Strength (2019-20)	Academic Staff Strength (2019-20)	Non-academic Staff Strength (2019-20)	Status Phase-1	Reason Phase-1	Comment Phase-1	Document Phase-1	Remarks Phase-1	Status Phase-2	Reason Phase-2	Comment Phase-2	Document Phase-2	Remarks Phase-2
1	Incubation Center	Incubation Unit	Multisector	At all level	Technical	410	31	0	Approved									
	Industry Institute Interaction cell	Industry Institute Interface Unit	Engineering and Technology	At all level	Technical	0	66	6	Approved									
	Entrepreneurship Development Cell	Pre-incubation unit	Multidisciplinary	UG / PG / PhD	Technical	100	5	0	Approved									
	Center of Excellence in VLSI design	Centre of Excellence with Advance Tools & Equipment	Electronics and Communication Engineering	UG / PG / PhD	Technical	120	5	2	Approved									
5	Center of Excellence in Embedded Systems and IoT	Centre of Excellence with Advance Tools & Equipment	Electronics and Communication Engineering	At all level	Technical	30	6	2	Approved									
6	Centre for Advancement of Career guidance and Human Excellence (CACHE)	Industry Institute Interface Unit	Multidisciplinary	At all level	Non-Technical	0	30	10	Approved									
7	IBM Center of Excellence	Centre of Excellence with Advance Tools & Equipment	Computer Science and Engineering	UG / PG / PhD	Technical	1	5	1	Approved									

Geetanjali College of Engg. and Tech.  
 Principal  
 Cheeryal (V), Keesara (M), Merchar Dist. (R.S.) 501 301.



**Institutions' Innovation Council (2020-21) Annual Performance:  
College & Standalone Institutions Category**

IIC ID	AISHE CODE	Institute Name	State	Star Rating
IC202014764	C-21408	Govt. College for Women Nawakadal	Jammu and Kashmir	1
IC202115637	C-29448	BAM Khalsa College, Garhshankar	Punjab	1
IC201911989	C-29461	CGC College of Engineering	Punjab	1
IC202014834	C-29299	Guru Hargobind Institute Of Law for Women	Punjab	1
IC202014339	C-10423	Khalsa College of Engg. and Technology	Punjab	1
IC201811188	C-25148	College of Engineering & Technology	Rajasthan	1
IC201810272	C-25235	Jaipur Engineering College	Rajasthan	1
IC201810439	S-309	JAIPURIA INSTITUTE OF MANAGEMENT	Rajasthan	1
IC201810961	C-13008	Sophia Girls College	Rajasthan	1
<b>South-Central/SCRO</b>				
IC201810598	C-18060	ADITYA COLLEGE OF ENGINEERING & TECHNOLOGY	Andhra Pradesh	4
IC201811908	C-24171	Anil Neerukonda Institute Of Technology & Sciences	Andhra Pradesh	4
IC202014297	c-23939	Ch.S.D. St. THERESASA COLLEGE FOR WOMEN	Andhra Pradesh	4
IC201912705	C-17948	DADI Institute of Engineering & Technology	Andhra Pradesh	4
IC201810033	C-17913	Gayatri Vidya Parishad College of Engineering	Andhra Pradesh	4
IC201810087	C-17999	Kallam Harinatha Reddy Institute of Technology	Andhra Pradesh	4
IC201811654	C-18118	KKR&KSR Institute of Technology & Sciences	Andhra Pradesh	4
IC201811104	C-17916	PACE Institution of Technology & Sciences	Andhra Pradesh	4
IC201810612	C-17997	QIS College of Engineering & Technology	Andhra Pradesh	4
IC201810490	C-26929	Sree Vidyanikethan Engineering College	Andhra Pradesh	4
IC201810018	C-26990	Sri Venkateswara College of Engineering, Tirupathi	Andhra Pradesh	4
IC201912177	C-18003	Vasireddy Venkatadri Institute of Technology	Andhra Pradesh	4
IC201810415	C-18010	Velagapudi Ramakrishna Siddhartha Engineering College	Andhra Pradesh	4
IC201912589	C-18099	Vishnu Institute of Technology	Andhra Pradesh	4
IC201912495	C-48145	BVRIT Hyderabad College of Engineering for women.	Telangana	4
IC201810509	C-25622	Chaitanya Bharathi Institute of Technology	Telangana	4
IC201810032	C-19735	CMR College of Engineering & Technology	Telangana	4
IC201810264	C-19837	CMR Institute of Technology	Telangana	4
IC201811279	C-19705	CMR Technical Campus	Telangana	4
IC201810433	C-27588	Geethanjali College of Engineering and Technology	Telangana	4
IC201811632	C-19534	Gokaraju Rangaraju Institute of Engineering and Technology	Telangana	4
IC201810476	C-19531	Guru Nanak Institute of Technology	Telangana	4
IC201811959	C-19515	Guru Nanak Institutions Technical Campus	Telangana	4
IC201811436	C-19850	Hyderabad Institute of Technology & Management	Telangana	4

Principal  
Cheerla (V), Keesara (M), Medchal Dist. (TS)-501 301.



# Geethanjali College of Engineering and Technology

CHEERYAL (V), KEESARA (M), Medchal DIST-501301, Telangana

Oct 2020

Activities planned by GCET's Institution Innovation Council for the Academic Year 2020-21

Semester - I		
Quarter – I and II		
1	IIC council formation or upgradation (of existing council) at institute level. Conduct first council meeting	19 <sup>th</sup> Nov 2020
2	My Story - Motivational Session by Successful Innovators	18 <sup>th</sup> Dec 2020
3	Session on Problem Solving and Ideation Workshop	28 <sup>th</sup> Dec 2020
4	Orientation Session on National Education Policy (with a focus on Innovation and entrepreneurship)	29 <sup>th</sup> Dec 2020
5.	Orientation session for all students & faculties of Institute by Innovation Ambassador(s).	8 <sup>th</sup> Jan 2021
6.	Business Plan/Prototype Competition to Invite Innovative Business Models from Students	9 <sup>th</sup> Jan 2021
1	IIC Council Meeting- Review of Q1 progress and Planning for Q2.	29 <sup>th</sup> Jan 2021
2	Orientation Session on National Innovation and Startup Policy (NISP)	30 <sup>th</sup> Jan 2021
3	Workshop on Design Thinking, Critical thinking and Innovation Design	13 <sup>th</sup> Feb 2021
4.	Ideathon – Idea competition for students of GCET and also local high schools	20 <sup>th</sup> Feb 2021
5	Session on identifying Intellectual Property component at the early stage of Innovation	27 <sup>st</sup> Feb 2021
6	Field/Exposure Visit to Fab lab, Makers Space, Design Centres, City clusters etc.	27 <sup>th</sup> Feb 2021
Semester – II Quarter – III		
1.	IIC Council Meeting- Review of Q2 progress and Planning of Q3.	6 <sup>th</sup> Mar 2021
2	Business Plan/Prototype Competition to Invite Innovative Business Models from Student	6 <sup>th</sup> Mar 2021
3	Idea/ PoC pitching & validation and Institute level PoC competition. Submission of Idea/PoC on IIC Portal	19 <sup>th</sup> Mar 2021
4	Session on "How to plan for Start-up and legal & Ethical Steps"	20 <sup>th</sup> Mar 2021
5	Mentorship Session for Innovators (or) Student Entrepreneurs through experts and (or) Innovation Ambassadors/Innovation Agent	20 <sup>th</sup> Mar 2021
6	Orientation session for all students & faculties of Institute by Innovation Ambassador(s).	27 <sup>th</sup> Mar 2021
Semester – II Quarter – IV		
1	IIC Council Meeting- Review of Q3 progress and Planning of Q4	3 <sup>rd</sup> Apr 2021
4	Field/Exposure Visit to Incubation Unit/Patent Facilitation Centre/Technology Transfer Centre/ Co-working spaces	10 <sup>th</sup> Apr 2021
2	Session on Prototype Validation - Converting Prototype into a Startup	17 <sup>th</sup> Apr 2021
3	Session on Accelerators/Incubation - Opportunities for Students & Faculties - Early Stage Entrepreneurs	24 <sup>th</sup> Apr 2021
4	Session/ Workshop on Business Model Canvas (BMC)Session/ Workshop on Business Model Canvas (BMC)	8 <sup>th</sup> May 2021
4	Session on Angel Investment/VC Funding Opportunity for Early Stage Entrepreneurs	8 <sup>th</sup> May 2021
5	Semester Break : Internship at startup.	7 <sup>th</sup> Jun 2021

PRINCIPAL  
Geethanjali College of Engg. and Tech.  
Cheeryal (V), Keesara (M), Medchal Dist (T.S.)-501301.





Phone : 040-23340113, 040-23345071  
Email : scro@aicte-india.org  
Website : www.aicte-india.org



साम्प्रदायिक शिक्षा

## अखिल भारतीय तकनीकी शिक्षा परिषद

(भारत सरकार का एक सांविधिक निकाय)

(मानव संसाधन विकास मंत्रालय, भारत सरकार)

### ALL INDIA COUNCIL FOR TECHNICAL EDUCATION

(A Statutory Body of the Govt. of India)

(Ministry of Human Resource Development, Govt. of India)

#### South Central Regional Office

Block No. : 201 to 204 & 221 to 224, 2nd Floor,  
Swarna Jayanthi Commercial Complex,  
Ameerpet, Hyderabad - 500 038

SCRO-AICTE/CVA-2019/4884

Date: 06.12.2019

To

The Principal/MD,  
Geethanjali College of Engineering and Technology,  
Cheeryal Village,  
Keesara Mandal,  
Hyderabad,  
Telangana 501301

Sir,

**SUB:** Conducting Chhatra Vishwakarma Awards - 2019 - Reg.

All India Council for Technical Education (AICTE) is planning to hold a competition of "Chhatra Vishwakarma Awards - 2019 (Outstanding Innovative Team Awards) in the Southern Region on 13<sup>th</sup> December 2019.

All Institutions/Students as approved by AICTE are covered under this award. Awards will be given in following categories:

- Category - I: Chhatra Vishwakarma awards for Outstanding Innovative Team (Students & Mentor).
- Category - II: Utkrisht Sansthan Vishwakarma Award for exemplary Institutional Intervention.

The above awards aims to recognize and honour innovative work of the students displaying exceptional skills in different categories to provide the innovative solution to the problem statement. The theme for this year's award is "How to enhance the income of a Village".

Date finalized is 13<sup>th</sup> Dec, 2019.

The requirements for holding the above event are:

- The No. of groups participating is 32 (about 100 to 120 students).
- Accommodation for outstation students who might come in a day early.
- 32 Tables with chairs and with Power outlets and Wi-Fi.
- About 8 - 10 Judges in groups of two will walk through the demonstration.
- One room for the judges for discussion and selection of teams.
- Dinner for the out station students who come on previous night i.e., on 12.12.2019 and also breakfast on 13.12.2019 morning for them.
- On 13<sup>th</sup> morning snacks and Tea/Coffee, afternoon lunch and evening Snacks and tea for all the participants and also for judges.

Cont. Page - 2

PRINCIPAL  
Geethanjali College of Engg. and Tech.  
Cheeryal (V), Keesara (M), Medchal Dist.(T.S.)-501 301



सूचना का  
अधिकार



and the recommendations thereafter.

- We were introduced to the principal Dr. VA Narayana (Retired Army Major) and our visit was intimidated the Chairman Mr. Gopal Reddy
- Incubation center is headed by Dr. Merugu Suresh who is also Dean R&D; he obtained his Ph.D from Roorkee in 2016 (ECE) on sponsorship from CMRCET.
- CMRCET is a member of the Indo Universal Collaboration for Engineering Education (IUCEE) consortium universities.
- About 30 faculty members from different disciplines were chosen (although some of them were relucta initially) and attended a workshop on Design thinking for 15 days at KLE Tech Hubli in 2016. **CMRCET h taken, KLE Tech's curriculum as a model for innovation and incorporated the same.**
- All the above thirty are assigned to 'center of innovation and creativity' in a dedicated manner, which is i itself existing as separate department, offering the following courses.
  1. First year I semester has a two credit course called as '**Social Innovation in Practice**', where studen of different disciplines with at least one (but generally two) girl(s) student form teams of four to s students and visit communities one faculty for every 15 students. They will have to prepare a 'poste in a predefined format with the following headings and presented by the students, which evaluated (in prakalp pradarshan) by a committee from consortium of colleges.
    - Existing systems
    - User requirement
    - Issues in the existing system
    - Technology 'Gaps identified'
    - Methodology proposed to solve a problem
  2. I Year II semester has another two credit course called as '**Engineering exploration**', where the sam team shall continue working to build a physical working model of their proposed solution afte visiting nearby villages/community and interact to define a problem statement.
  3. **Project based learning (PBL)** course is offered in II Year I semester.
  4. They offer Skill based training to unemployed youth of the nearby villages
- They continue doing this. 'Value addition' by faculty from other departments is done after the above stage where faculty send research proposals to funding organizations that are appropriate to the projects already done, producing even research papers.
  - A 3Cr. Projects sponsored by DST resulted from this process supporting innovations to help the nearby villages by way of fabricating, distributing machines to separate ground nuts from it's crop.
- They have collaboration/MoUs with

Organization (s)	Purpose
TiE The Indus Entrepreneurs (Hyderabad Chapter)	Facilitate the visit of Angel Investors, High Netwoth Individuals (HNI), Mentoring support during project demos/exhibitions/competitions.
Bennet University (Times Group)	Technology support as part of IUCEE consortium
Purdue University	Technology and curriculum support as part of IUCEE consortium
Brunnel University UK London, Bennet India, CMRCET	Usage of Supercomputer E52690 Dual Xeno 256GB, 18TP, 128 GB Ram, NVIDIA GPU tensor flow,
Member with Cybersecurity NSDC since 2016	





The Federation of Telangana  
Chambers of Commerce and Industry



# Three day Entrepreneur Mentorship Programme

Date & Time : 24th, 25th, 26th November, 2021 at 10.00 AM to 5.00 PM  
Venue: Federation House, FTCCI, Hyderabad

[Click Here for  
Registration](#)

## Sessions

### Day One

- ▶ Pros & Cons of Entrepreneurship
- ▶ Identification of business opportunities
- ▶ Project Feasibility
- ▶ Working capital Management

### Day Two

- ▶ Preparing Project report.
- ▶ License & Approval
- ▶ MSME Schemes
- ▶ Digital Technology

### Day Three

- ▶ Basic Accounting
- ▶ Business Project Report (Case Study)
- ▶ Assessment of BPR

WHO SHOULD  
ATTEND

Startups, Bootstrappers,  
and Students.

**Delegate Fee: Rs. 1000/-**  
(Incl 18%GST)

NEFT Details: For NEFT /  
RTGS: FTCCI, SBI, Bazarghat (Br),  
Hyderabad:

Account No. 10005356049  
IFSC: SBIN0005893 GST :  
36AAFCT2444K1Z6

Fee includes  
Course material  
Lunch &  
Refreshments

Scan & Pay



**K.Bhasker Reddy**  
President

**Anil Agarwal**  
Senior Vice President

**Meela Jayadev**  
Vice President

RSVP : Ms.Hinduja Ph : 7670908388 e-Mail : hinduja@ftcci.in

*Dr. Anil & Dr. Madhuri from ECE*  
*Prof. Sivakumar from ECE*

PRINCIPAL  
Geethanjali College of Engg. and Tech.  
Cheeryal (V), Keesara (M), Medchal Dist.(T.S.)-501 301.

*Sita*  
*9/22/11/21*





This is to certify that

Dr. Anil Kumar Puppala

of

GEETHANJALI COLLEGE OF ENGINEERING AND TECHNOLOGY, Telangana

has successfully completed Innovation Ambassador Training conducted by  
MoE's Innovation Cell & AICTE, New Delhi.

Prof. Anil D. Sahasrabudhe  
Chairman, AICTE

Dr. Abhay Jere  
CIO, MoE's, Innovation Cell

Certificate No : 2345

Validity: For IIC 3.0 Calendar Year

Date of Issue: 16-02-2021

PRINCIPAL  
Geethanjali College of Engg. and Tech.  
Cheeryal (N), Narsara (M), Nandhal Dist. (TS)-501 301.





This is to certify that

Dr. A Gagan Deep  
of

Geethanjali College of Engineering and Technology, Telangana

has undergone Innovation Ambassador training (Foundation Level)  
conducted by MoE's Innovation Cell & AICTE during the period from  
30<sup>th</sup> June - 30<sup>th</sup> July 2021 in online mode.

Prof. Anil D. Sahasrabudhe  
Chairman, AICTE

Dr. Abhay Jere  
CIO, MoE's, Innovation Cell

Date of Issue: 30-07-2021

E-certificate No : 8522

PRINCIPAL  
Geethanjali College of Engg. and Tech.  
Cheerlyal (V), Kasara (M), Medchal Dist. (T.S.)-501 301.



This is to certify that

Dr. Nagamani  
of

Geethanjali College of Engineering and Technology, Telangana

has undergone Innovation Ambassador training (Foundation Level)  
conducted by MoE's Innovation Cell & AICTE during the period from  
30<sup>th</sup> June - 30<sup>th</sup> July 2021 in online mode.

Prof. Anil D. Sahasrabudhe  
Chairman, AICTE

Dr. Abhay Jere  
CIO, MoE's, Innovation Cell

Date of Issue: 30-07-2021

E-certificate No : 8555

PRINCIPAL  
Geethanjali College of Engg. and Tech.  
Chesyal (V), Keesara (M), Medchal Dist. (T.S.)-501 301.





This is to certify that

Preeti Prasada

of

GEETHANJALI COLLEGE OF ENGINEERING AND TECHNOLOGY, Telangana

has undergone Innovation Ambassador training (Advanced Level)  
conducted by MoE's Innovation Cell & AICTE during the period from  
30<sup>th</sup> June - 30<sup>th</sup> July 2021 in online mode.

Prof. Anil D. Sahasrabudhe  
Chairman, AICTE

Dr. Abhay Jere  
CIO, MoE's, Innovation Cell

Date of Issue: 30-07-2021

E-certificate No : 2341

Geethanjali College of Engg. and Tech.  
Cheeraj (V), Keeravani (M), Medchal Dist.(T.S.)-501 301.



This is to certify that

Mr. Sandeep

of

Geethanjali College of Engineering and Technology, Telangana

has undergone Innovation Ambassador training (Foundation Level)  
conducted by MoE's Innovation Cell & AICTE during the period from  
30<sup>th</sup> June - 30<sup>th</sup> July 2021 in online mode.

Prof. Anil D. Sahasrabudhe  
Chairman, AICTE

Dr. Abhay Jere  
CIO, MoE's, Innovation Cell

Date of Issue: 30-07-2021

E-certificate No : 8524

Geethanjali College of Engineering and Tech.  
Cheerla (V), Narsara (M), Medchal Dist. (R.S.) 501 301.





This is to certify that

Sudarshan Rikka

of

Geethanjali College of Engineering and Technology, Telangana

has undergone Innovation Ambassador training (Foundation Level)  
conducted by MoE's Innovation Cell & AICTE during the period from  
30<sup>th</sup> June - 30<sup>th</sup> July 2021 in online mode.

Prof. Anil D. Sahasrabudhe  
Chairman, AICTE

Dr. Abhay Jere  
CIO, MoE's, Innovation Cell

Date of Issue: 30-07-2021

E-certificate No : 8519

PRINCIPAL  
Geethanjali College of Engg. and Tech.



This is to certify that

Mr. Dasu Vaman Ravi prasad

of

Geethanjali College of Engineering and Technology, Telangana

has undergone Innovation Ambassador training (Foundation Level)  
conducted by MoE's Innovation Cell & AICTE during the period from  
30<sup>th</sup> June - 30<sup>th</sup> July 2021 in online mode.

  
Prof. Anil D. Sahasrabudhe  
Chairman, AICTE

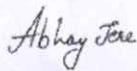
  
Dr. Abhay Jere  
CIO, MoE's, Innovation Cell

Date of Issue: 30-07-2021

E-certificate No : 8523

Geethanjali College of Engg. and Tech.  
Geethanjali (V), Keesara (M), Medchal Dist (TS), 501 301.





MHRD'S  
**INNOVATION CELL**  
(GOVERNMENT OF INDIA)



**INSTITUTION'S  
INNOVATION  
COUNCIL**  
(Ministry of HRD initiative)



## CERTIFICATE OF PARTICIPATION

**Dr. Anil Kumar Puppala**

Geethanjali College of Engineering and Technology

Successfully Completed Training on "Pre- Incubations & Incubation Management" conducted as part of

**IIC Innovation Ambassador Training Series**

Organized by Institution's Innovation Council of MHRD's Innovation Cell, AICTE held at  
MLR Institute of Technology, Hyderabad, Telangana on 6-7 February 2020.

Prof. Anil D. Sahasrabudhe  
Chairman  
AICTE

Prof. M.P. Poonia  
Vice Chairman  
AICTE

Dr. Abhay Jere  
Chief Innovation Officer  
MHRD's Innovation Cell



scan to verify

eCertificate No : 1053

Date of issue: 15-02-2020

Geethanjali College of Engg. and Tech.  
Cheerla (V), Keesara (M), Medchal Dist.(T.S.)-501 301.